

ITEM# 81385

Chocolate Bronze 25" H, 46" W Corner W/Storage

Leick
Home
SINCE 1910

2219 S. 19th St.

Sheboygan, WI 53081



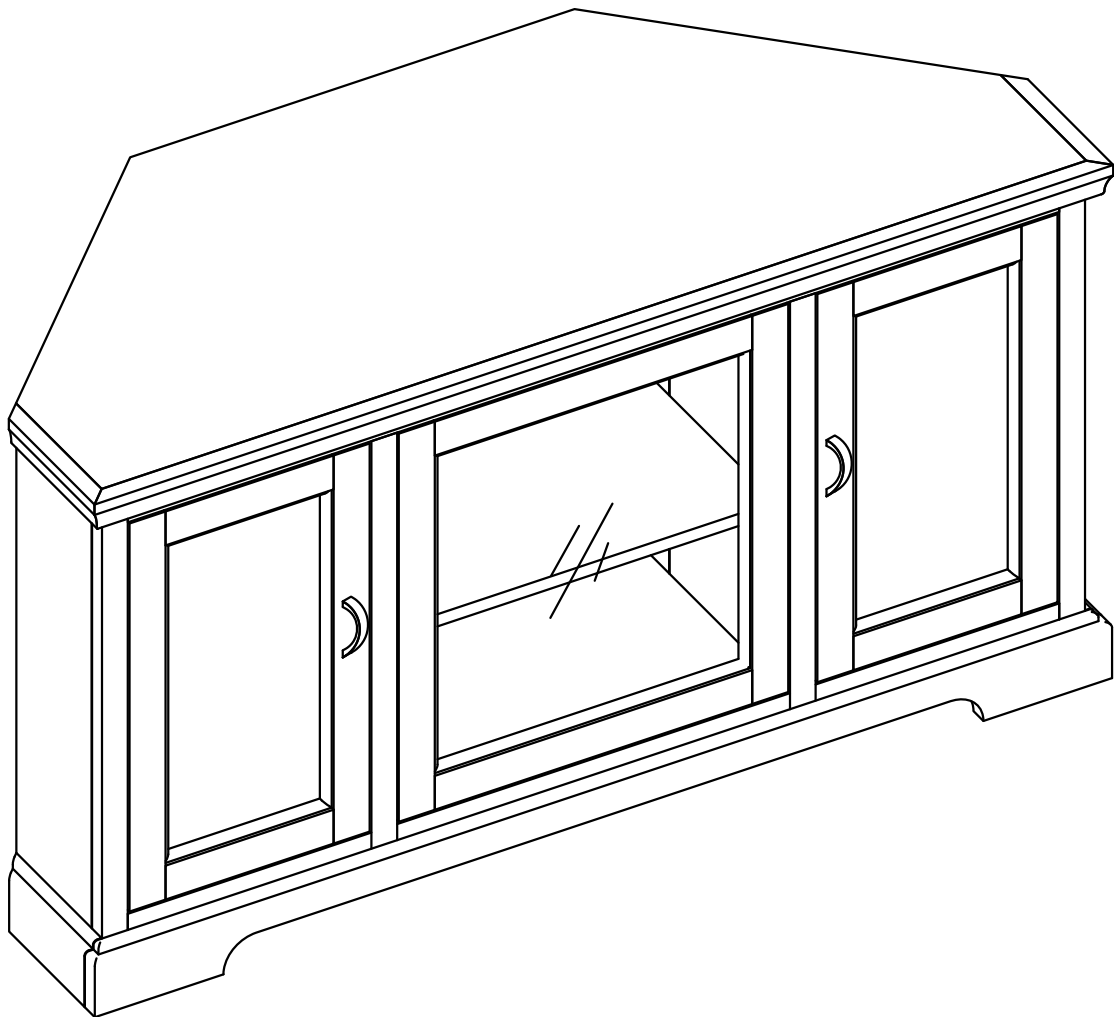

Ph: 920-451-4060

Fax: 920-451-4063

info@leickfurnituresince1910.com

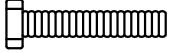

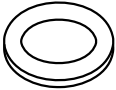
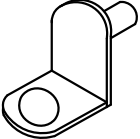
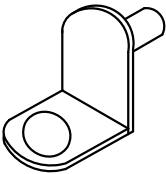
Hardware List

	Item	Description	Qty
a		Bolt 1/4"*1-1/8"	3PCS
b		Allen wrench	1PC
c		Washer 1/4"*12mm	3PCS
d		Shelf metal clip	12PCS
e		Bigger shelf metal clip	2PCS
f		Door Pull	2PCS
g		Machine screw for door pull 5/32"*3/4"	4PCS

Parts List

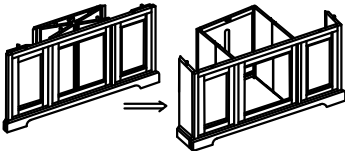
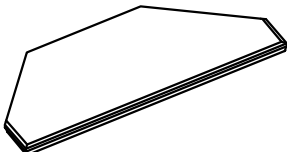
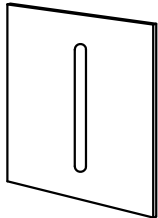
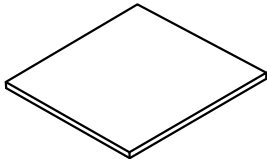
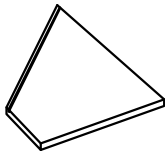
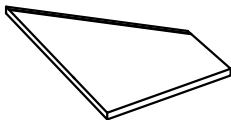
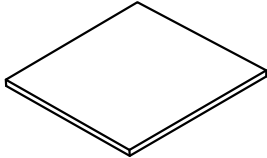
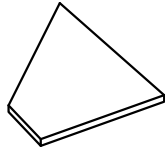
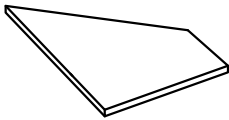
Item	Description	Qty
A 	Cabinet	1PC
B 	Top Panel	1PC
C 	Side Back Panel	2PCS
D 	Middle Bottom Panel	1PC
E 	Left Side Bottom Panel	1PC
F 	Right Side Bottom Panel	1PC
G 	Middle Adjustable Shelf	1PC
H 	Left Side Adjustable Shelf	1PC
I 	Right Side Adjustable Shelf	1PC

Assembly Instructions

Two person assembly recommended.

step 1

Unfold Cabinet.

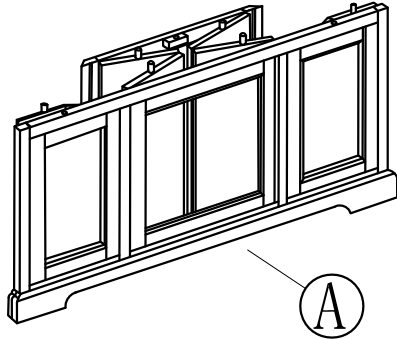

step 2

Install two bigger shelf clips on the side bottom.

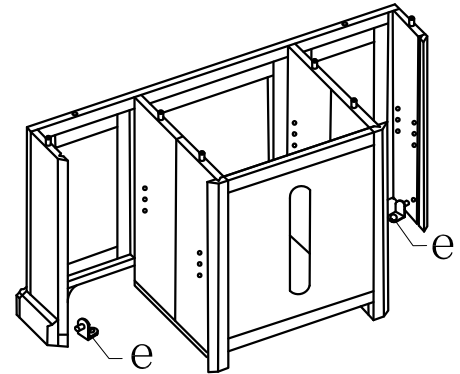

step 3

Insert the center bottom panel first, then insert the side bottom panel.

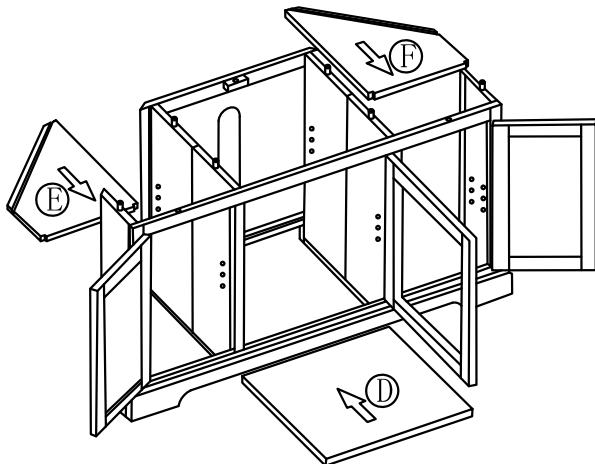

step 4

Insert two side back panels.

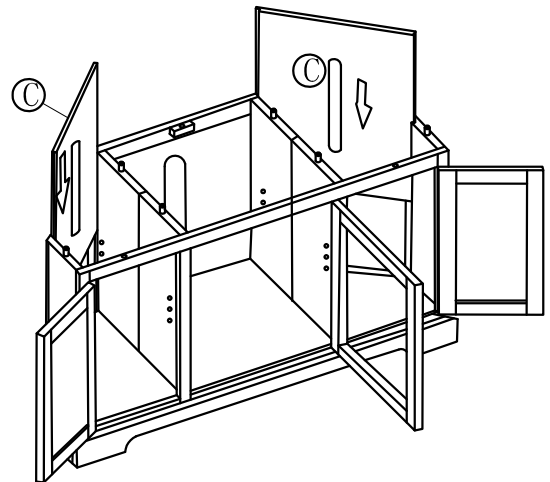

step 5

Bolt on top with 3 bolts.

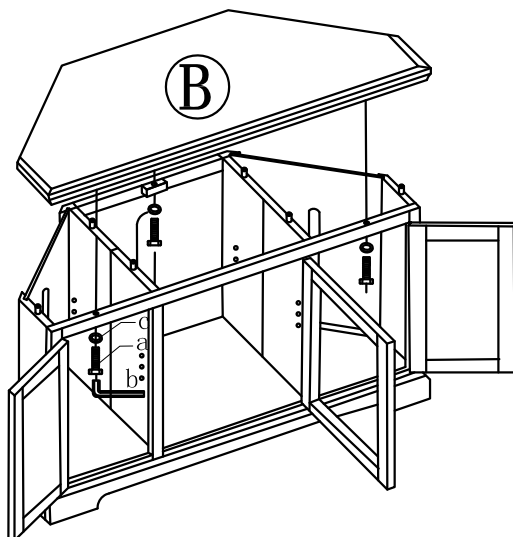

step 6

Install shelf clips and insert shelves and door pulls.

