

ASSEMBLY INSTRUCTIONS

Floor Cabinet w/1Dr

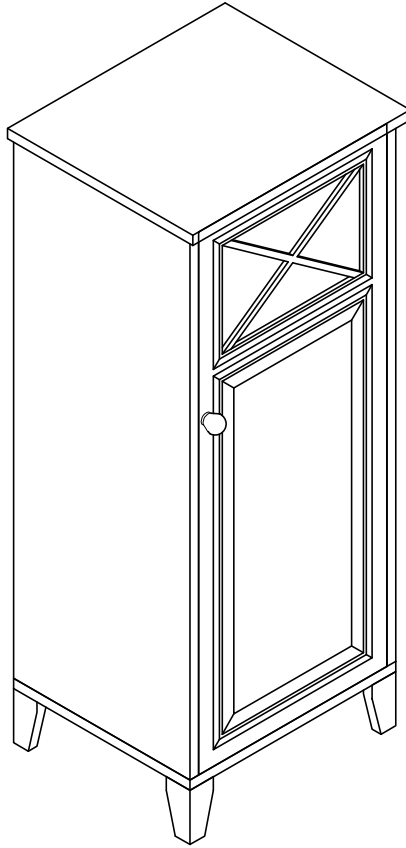

Please provide the following information when contacting for parts or questions: the name of the company you purchased from, the UPS/FedEx tracking number.

This product comes with a 1 year warranty. Products purchased second hand/used are not covered under the warranty.

ASSEMBLY INSTRUCTIONS-IMPORTANT

Carefully unpack & identify each component before attempting to assemble. Refer to parts list. Please take care when assembling the unit and always set the parts on a clean, soft surface. If you require any assistance with assembly, parts, please call the company you place order with or please email to:service@eleganthf.net

INSTRUCCIONES PARA ARMAR-IMPORANT:







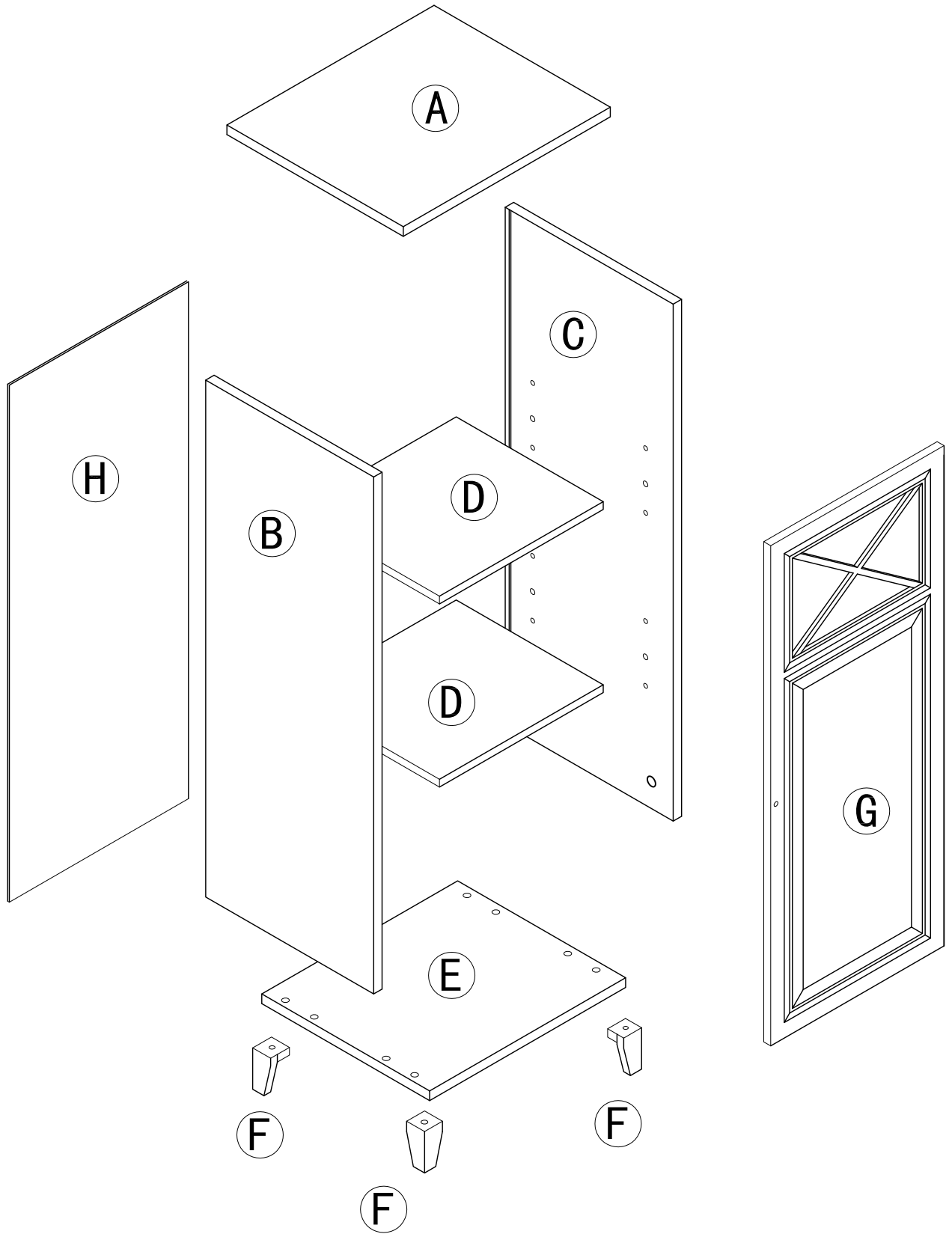

Desempaque cuidadosamente e identifique cada componente antes de tartar de empezar su ensambladura. Verifique la lista de partes. Por favor tenga cuidado cuando arme la unidad y siempre coloque las piezas sobre una superficie plana, suave y limpia. Si necesita ayuda con el armado, envíe un correo electzórico a service@eleganthf.net

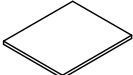
DIRECTIVES DE MONTAGE-IMPORTANT:



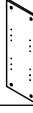







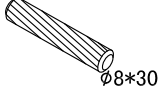

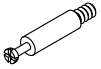
Avant de commencer l' assemblage, déballez délicatement toutes les pièces et repérez-les sur la liste des pièces. Procédez avec soins durant l' assemblage et posez toujours les pièces sur une surface proper, douce et lisse. sie vouo plait e-mail á service@eleganthf.net



COMPONENTS

PART	FIGURE	DESCRIPTION	QTY	PART	FIGURE	DESCRIPTION	QTY
A		TOP PANEL	1PC	E		BOTTOM SHELF	1PC
B		LEFT SIDE PANEL	1PC	F		FEET	4PCS
C		RIGHT SIDE PANEL	1PC	G		DOOR	1PC
D		ADJUSTABLE SHELF	2PCS	H		BACK PANEL	1PC

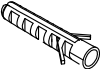
HARDWARE & TOOLS

PART	FIGURE	DESCRIPTION	QTY	PART	FIGURE	DESCRIPTION	QTY
1		WOODEN DOWEL	8PCS	9		KNOB	1PC
2		CAM BOLT	8PCS	10		SCREW	4PCS
3		CAM LOCK	8PCS	11		FIX BELT	1PC
4		SHELF PIN	8PCS	12		SCREW	2PCS
5		SCREW	4PCS	13		WASHER	2PCS
6		SCREW	12PCS	14		ANCHOR	1PC
8		KNOB BOLT	1PC				

TOOL NEEDED:



**PHILIPS SCREWDRIVER REQUIRED
- NOT INCLUDED**

SUGGESTION:



TWO PEOPLE FOR ASSEMBLING



WARNINGS:

1. DO NOT LET ANY SHARP OBJECTS TOUCH OR RUB THE SURFACE OF THE PRODUCT.
2. WHEN ASSEMBLING, DO NOT LET CHILDREN PLAY AROUND THE WORKING AREA.
3. PLEASE CONFIRM ALL PARTS ARE CORRECT BEFORE STARTING THE ASSEMBLY PROCESS.
4. DO NOT TIGHTEN ALL BOLTS AND SCREWS COMPLETELY UNTIL THE ENTIRE UNIT HAS BEEN ASSEMBLED AND SET UP.

1

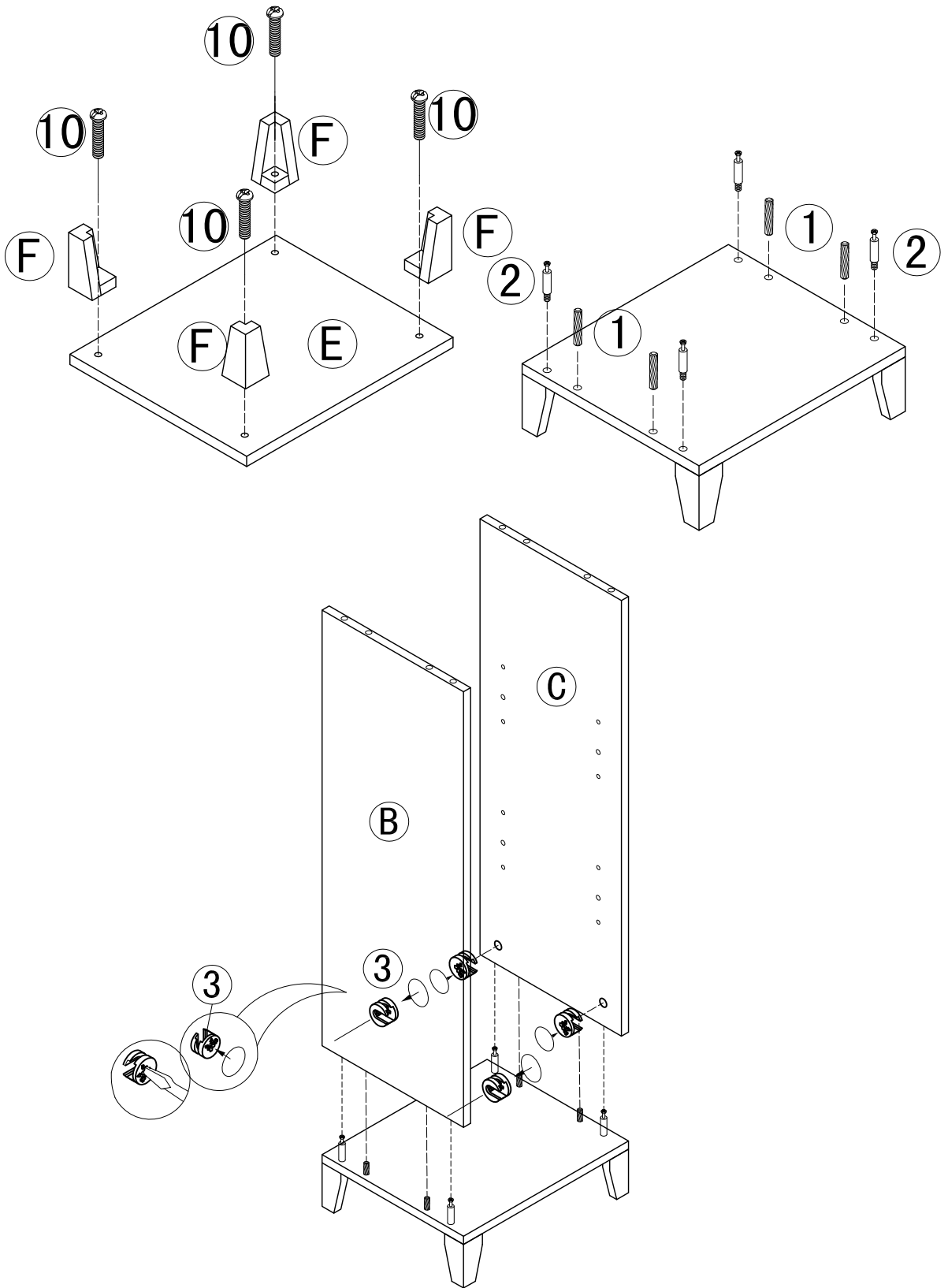
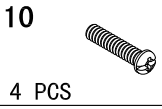
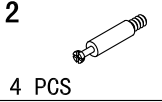

STEP 1:

1. Attach feet F to panel E with bolts (10).
2. Screw cambolts (2) and insert dowels (1) in panel E.
3. Attach panel B & C to panel E and secure with camlocks (3).

2

1
4 PCS

2
4 PCS

3
4 PCS $\phi 15 \times 9$

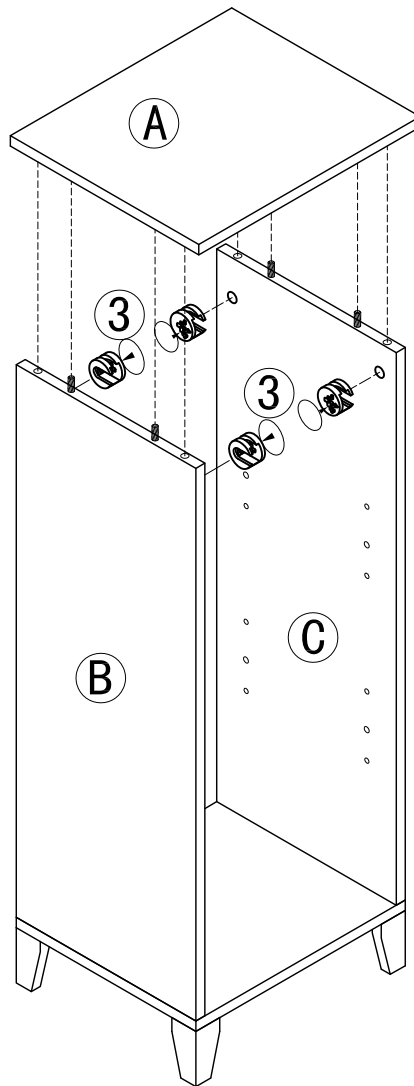
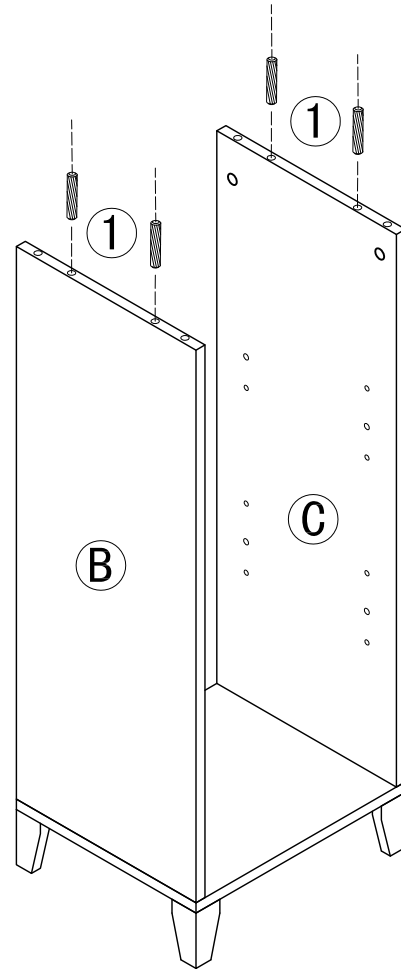
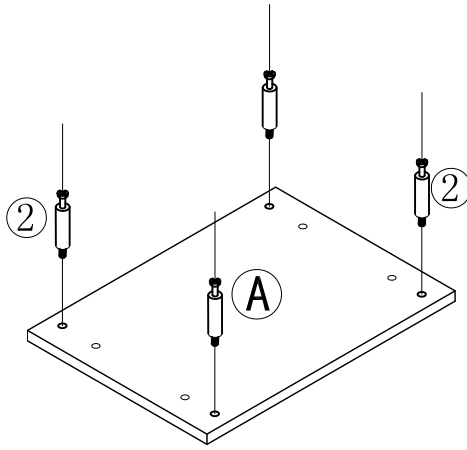

STEP 2:

1. Screw cambolts (2) into panel A.
2. Insert dowels (1) to the tops of panels B & C.
3. Attach panel A to panels B & C and secure with camlocks (3).

3

6



12 PCS $\phi 3 \times 12$ D=7

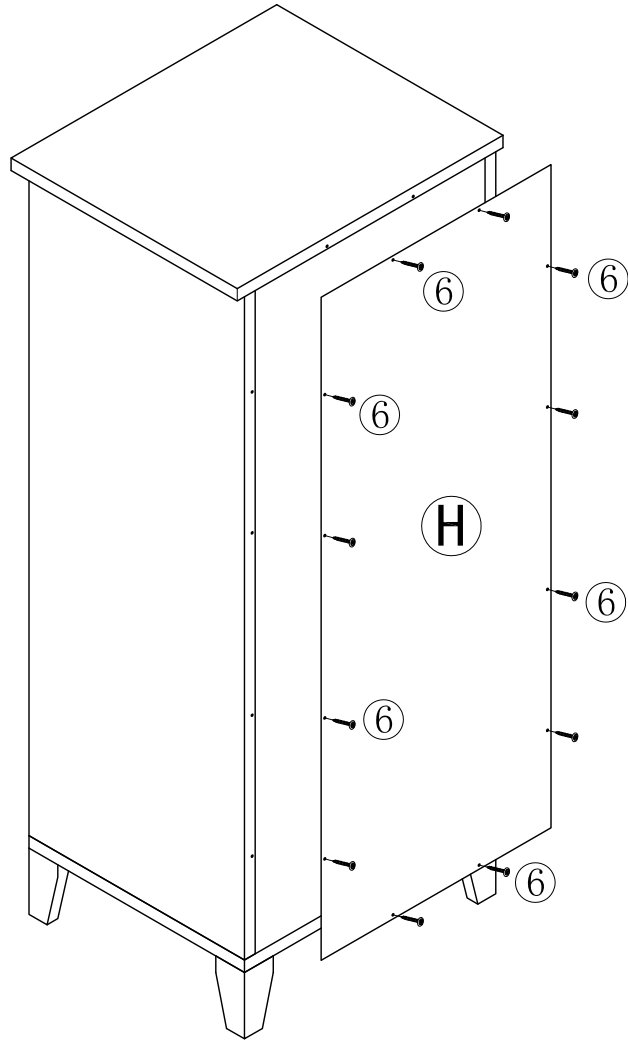

STEP 3:

- 1. Attach panel H to the back of the cabinet and secure with screws (6).**

4

4



8 PCS

5



4 PCS $\phi 3 \times 10$

8



1 PC

9





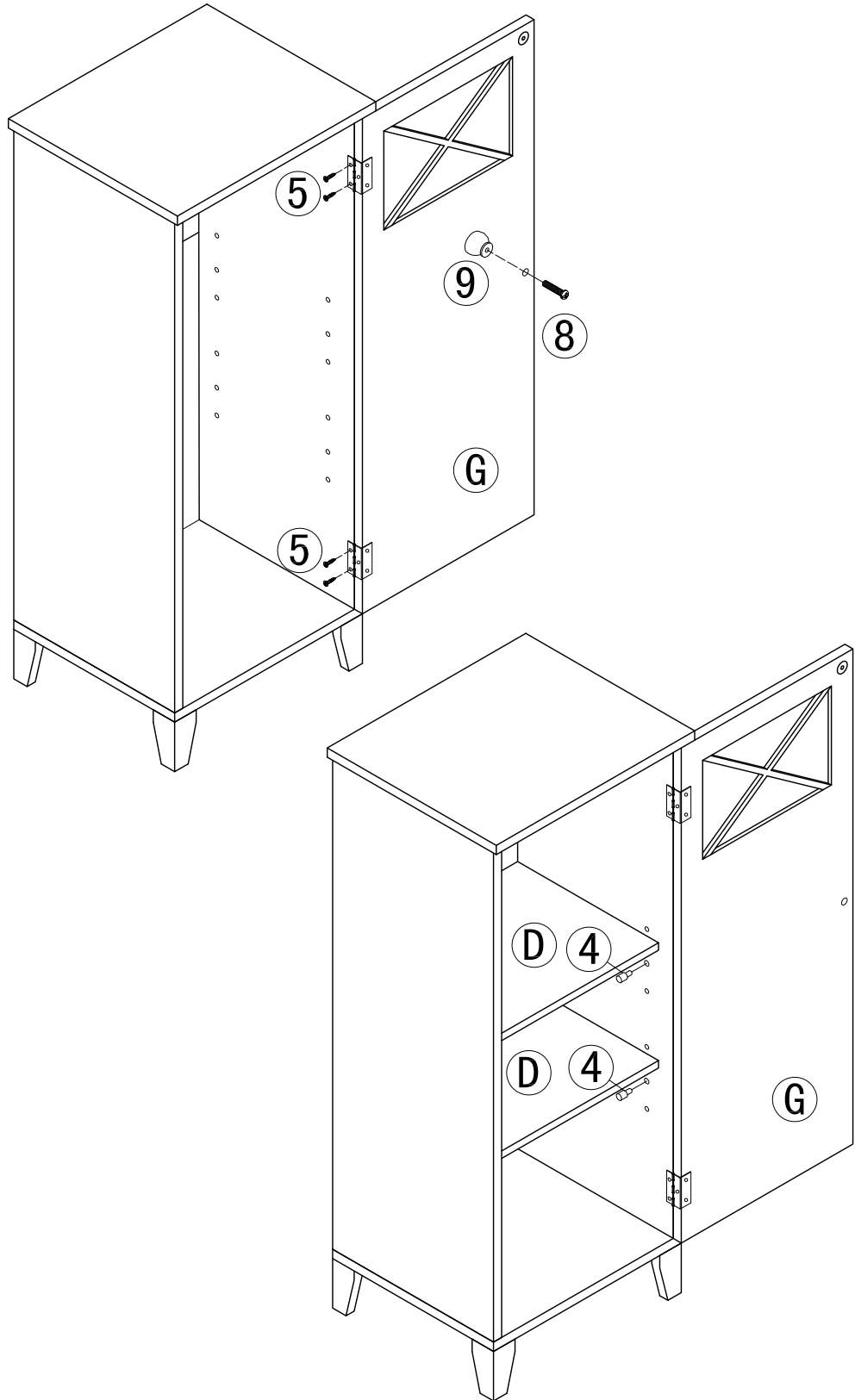

1 PC



STEP 1:

1. Attach knobs (9) to door G with bolt (8).
2. Attach door G to the cabinet with screws (5).
3. Insert shelf pins (4) into panels B & C.
4. Rest adjustable shelves D on the shelf pins.

5

- 11  1 PC
- 12  2 PCS $\phi 4 \times 25$
- 13  2 PCS
- 14  1 PC

