

Medusa

MED-BPHTB

Top/Bottom Mount
Pivot Hinge

Edge Mount Preferred Method $\frac{7}{16}$ " (11mm) Clearance



Do not measure images.
Use specified dimensions.

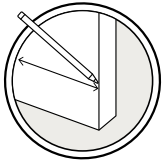

Measure from finished
edge of glass.

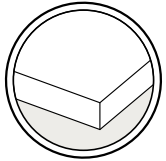

Use monolithic glass.

> **Glass Sizes:**

$\frac{5}{16}$ " (8mm) to $\frac{3}{8}$ " (10mm) thick
tempered safety glass

> **Maximum Door Capacities
for Two Hinges:**

Maximum Door Weight:
100 lbs. (46 kg)

Maximum Door Width:
31" (787mm)

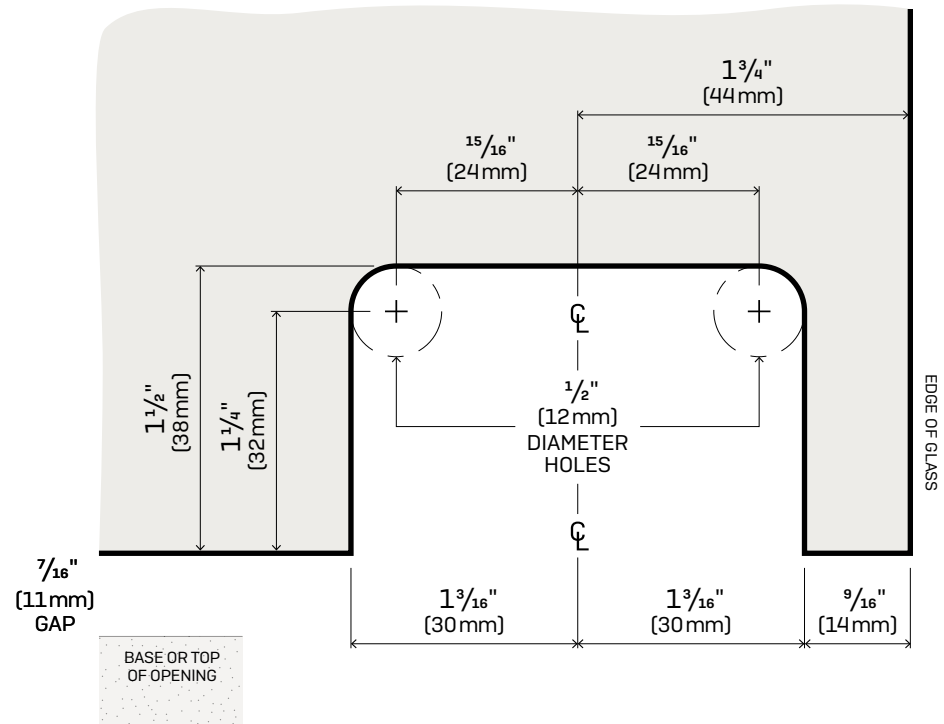
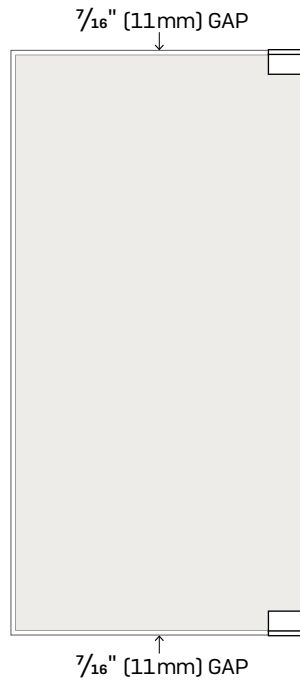

Medusa

MED-BPHTB

Top/Bottom Mount
Pivot Hinge

Edge Mount Alternate Method $\frac{7}{16}$ " (11mm) Clearance



Do not measure images.
Use specified dimensions.

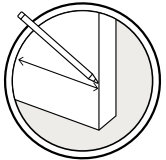

Measure from finished
edge of glass.

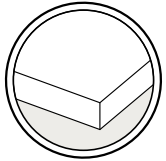

Use monolithic glass.

› **Glass Sizes:**

$\frac{5}{16}$ " (8mm) to $\frac{3}{8}$ " (10mm) thick
tempered safety glass

› **Maximum Door Capacities
for Two Hinges:**

Maximum Door Weight:
100 lbs. (46 kg)

Maximum Door Width:
31" (787mm)

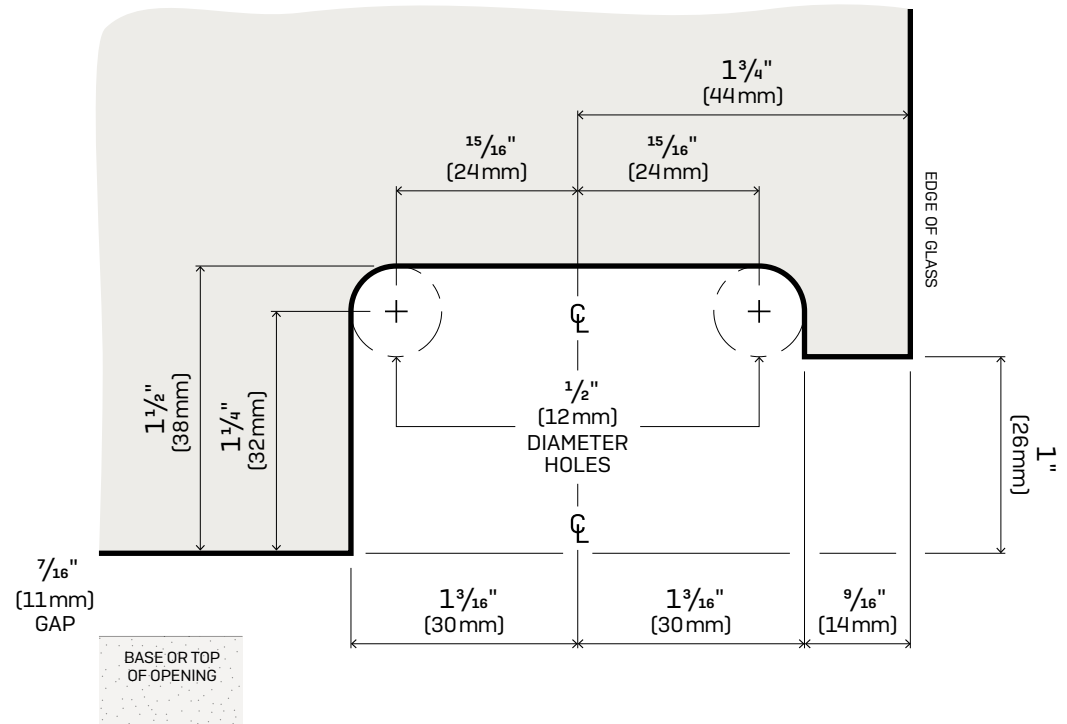
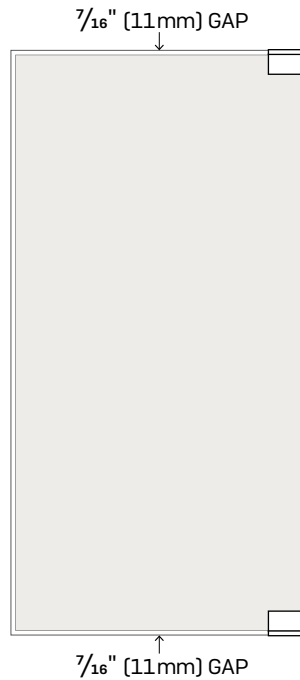

Medusa

MED-BPHTB

Top/Bottom Mount
Pivot Hinge

Edge Mount Alternate Method $\frac{1}{8}$ " (3mm) clearance

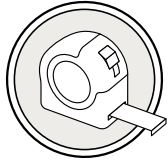

Do not measure images.
Use specified dimensions.

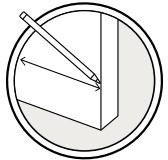

Measure from finished
edge of glass.

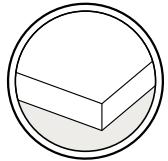

Use monolithic glass.

> **Glass Sizes:**

$\frac{5}{16}$ " (8mm) to $\frac{3}{8}$ " (10mm) thick
tempered safety glass

> **Maximum Door Capacities
for Two Hinges:**

Maximum Door Weight:

100 lbs. (46 kg)

Maximum Door Width:

31" (787mm)

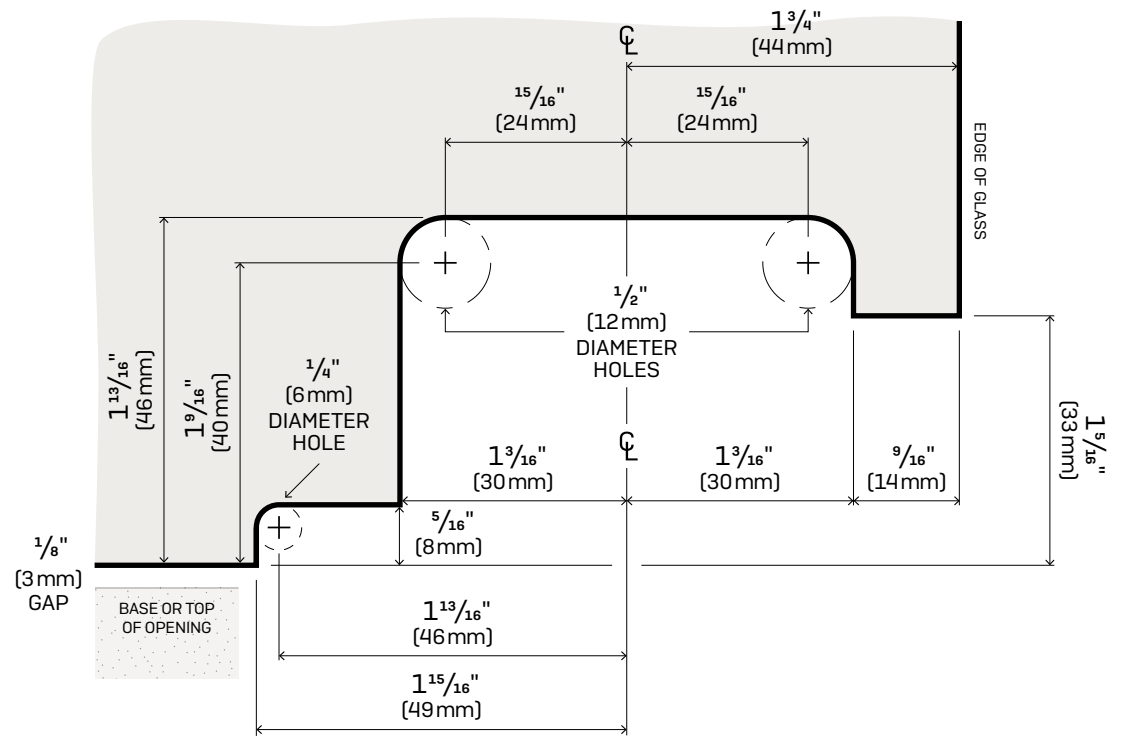
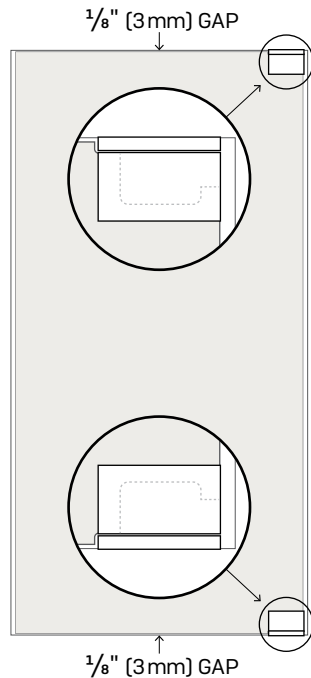

Medusa

MED-BPHTB

Top/Bottom Mount
Pivot Hinge

Edge Mount Alternate Method $\frac{3}{16}$ " (5mm) clearance

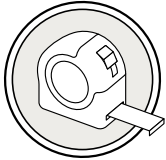

Do not measure images.
Use specified dimensions.

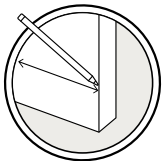

Measure from finished
edge of glass.

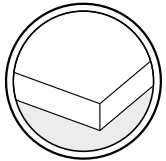

Use monolithic glass.

> **Glass Sizes:**

$\frac{5}{16}$ " (8mm) to $\frac{3}{8}$ " (10mm) thick
tempered safety glass

> **Maximum Door Capacities
for Two Hinges:**

Maximum Door Weight:
100 lbs. (46 kg)

Maximum Door Width:
31" (787mm)

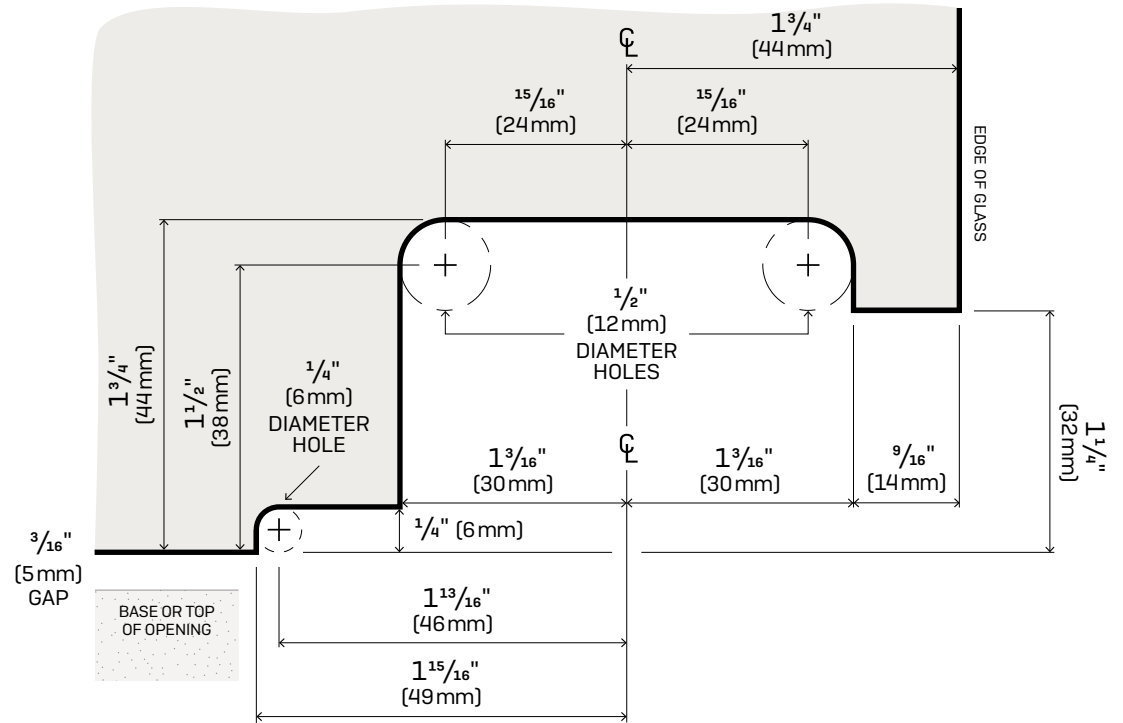
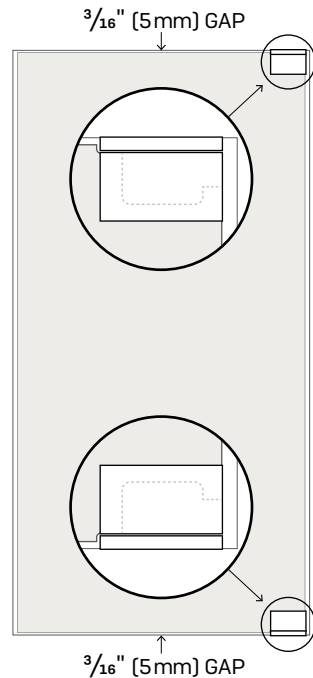

Medusa

MED-BPHTB

Top/Bottom Mount
Pivot Hinge

Variable Inset Mount Method $\frac{7}{16}$ " (11mm) Clearance

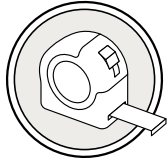

Do not measure images.
Use specified dimensions.

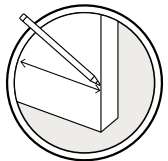

Measure from finished
edge of glass.

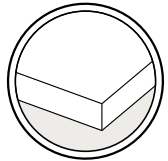

Use monolithic glass.

- > **Glass Sizes:**
 $\frac{5}{16}$ " (8mm) to $\frac{3}{8}$ " (10mm) thick
tempered safety glass

- > **Maximum Door Capacities
for Two Hinges:**

Maximum Door Weight:
100 lbs. (46 kg)

Maximum Door Width:
31" (787mm)

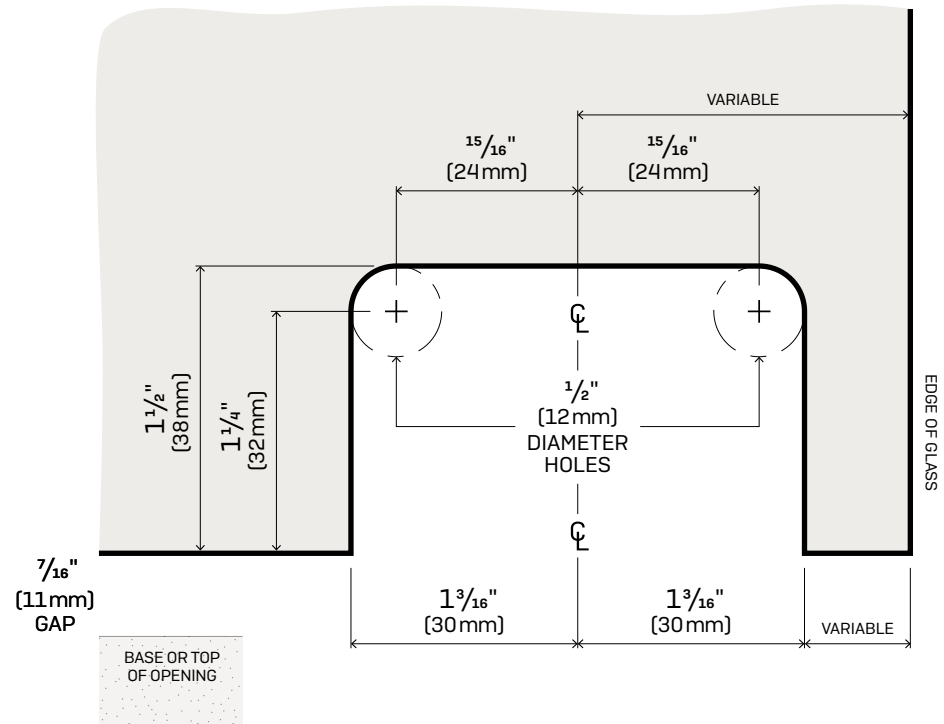
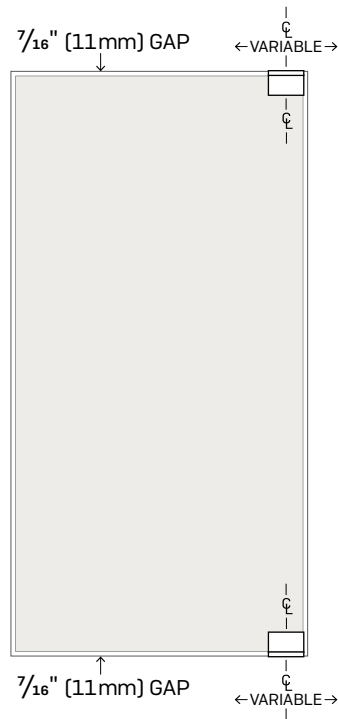

Medusa

MED-BPHTB

Top/Bottom Mount
Pivot Hinge

Transom Mount Method $\frac{3}{16}$ " (5mm) Clearance

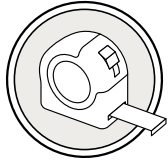

Do not measure images.
Use specified dimensions.

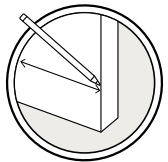

Measure from finished
edge of glass.

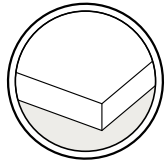

Use monolithic glass.

› **Glass Sizes:**

$\frac{5}{16}$ " (8mm) to $\frac{3}{8}$ " (10mm) thick
tempered safety glass

› **Maximum Door Capacities
for Two Hinges:**

Maximum Door Weight:
100 lbs. (46 kg)

Maximum Door Width:
31" (787mm)

