











# ASSEMBLY INSTRUCTION

ITEM: 6350-90267-95 Rookery 6/0-6/6 Upholstered Panel Headboard  
 6350-90268-95 Rookery 6/0-6/6 Panel Footboard  
 6350-90253-95 Rookery 6/6 Rails  
 6350-90263-95 Rookery 6/0 Rails

Thank you for purchasing this quality product. Be sure to unpack carefully looking for small parts which may have come loose during shipment.

Read all instruction and study the drawing carefully before starting the assembly process.

| HARDWARE PACK |   |               |            |        | PARTS LIST |  |             |       |
|---------------|---|---------------|------------|--------|------------|--|-------------|-------|
| NO.           | DRAWING   | DESCRIPTION   | SIZE       | Q'TY   | NO.        | DRAWING  | DESCRIPTION | Q'TY  |
| A             |  | Open Wrench   | Ø5/16"     | 1 PC   | 1          |  | Headboard   | 1 PC  |
| B             |  | Nut           | Ø5/16"     | 8 PCS  | 2          |  | Rail        | 2 PCS |
| C             |  | Curved Washer | Ø5/16"     | 8 PCS  | 3          |  | Footboard   | 1 PC  |
| D             |  | Threaded Rod  | 5/16*100mm | 8 PCS  | 4          |  | Slat        | 5 PCS |
| E             |  | Screw         | 8*32mm     | 20 PCS | 5          |  | Support Leg | 5 PCS |

**Please note the hardware bag to assemble side rails to HB&FB is in the box of side rails.**

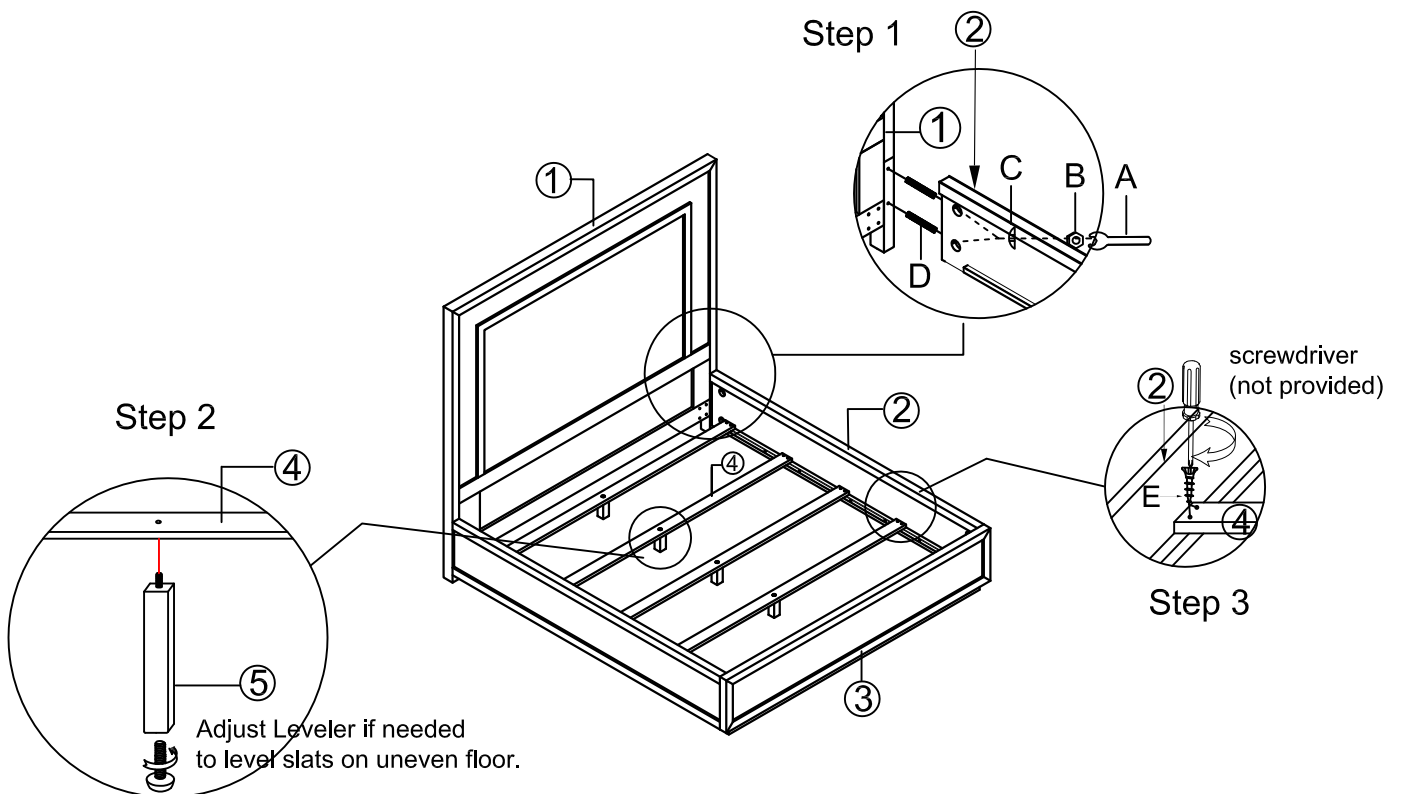

**Step 1:** Attach Rails (2) to Headboard (1) and Footboard (3) by using Threaded Rods (D), Curved Washers (C) and Nuts (B), tighten them with Open Wrench (A) .

**Step 2:** Attach support legs (5) to slats (4).

**Step 3:** Attach slats (4) to the rails (2) and tighten them by using Phillip head screwdriver.