

USER'S MANUAL

BV9384NV

BLUETOOTH® | BUILT-IN NAVIGATION
DVD/MP3/CD AM/FM RECEIVER

FEATURING 6.2" (157mm) WIDESCREEN TOUCHSCREEN
DIGITAL TFT LCD MONITOR



BOSS®
AUDIO SYSTEMS

To ensure safety while driving

and to comply with laws,

drivers should not watch video or

operate the video device while driving.

CONTENTS

General Information.....	1
Safety Notice.....	2
Accessories.....	3
Remote Control Operation.....	4
Unit Installation.....	6
Wires Connection Description.....	7
Panel Introduction.....	8
Main Menu Operation Instruction.....	9
Access Setup Interface.....	11
General Setup.....	11
Disc Setup.....	12
Audio Setup.....	13
Navigation Setup.....	13
Other Setup.....	14
SWC-Steering Wheel Control Setting.....	14
Radio Operation.....	17
Disc Playback-Video.....	17
Disc Playback-Audio.....	18
Music Playing Menu.....	19
Bluetooth Operation.....	19
Bluetooth Operation Menu.....	19
Bluetooth Dialing.....	20
Bluetooth Call.....	21
Bluetooth Phone Book.....	21
Bluetooth Phone Call History.....	22
Bluetooth Music Streaming-A2DP.....	23
Viewing Photos.....	23
Camera/Aux/A/V Menu.....	25
Troubleshooting.....	26

SPECIFICATIONS

Model No.	BV9384NV			
General features	Fixed front panel 6.2 inch TFT screen FM/AM Radio DVD fully compatible with DVD/VCD/CD/MP3/MPEG4/JPEG Built-in GPS Front USB & SD reader support Built-in Bluetooth AUX Input AV Input AV output Rear view camera Front, Rear and Subwoofer Pre-Amp Output 4*80W AMP power output maximum Steering wheel control			
TFT screen	800*480pixel			
SD	64G			
Working power	12 V			
Max Output	4*80W			
Working Temperature	-20°C~70°C / -4°F~158°F			
Size	96.5*170.5*144mm			
Weight	1.92kg / 4.23lbs			
Compatible Media				
Picture	JPG/JPEG/BMP/GIF/PNG			
Disc	CD/CD-R/CD-RW/DVD/DVD-R/DVD+R/ DVD-RW/DVD+RW			
Audio file	MP3/AAC/WAV			
Video file NOTE: O-YES X-NO	.AVI	MPEG/AC-3	MPEG-4	O
		MPEG/AAC	AVC	X
	MP4	MPEG/AAC	MPEG-4Visual	O
		AAC	AVC	X
	MPG	MPEG/AC-3	MPEG-1/2	O
		AAC	AVC	X
	RM	Cooker	RealVideo1	X
		Cooker	RealVideo3	O
RMVB	Cooker	RealVideo3	O	

SAFTY NOTICE

Please read and understand the following safety information before operating this unit.

⊘ The device is suitable for 12V power supply (requires grounding). Do not connect it to 24V power supply in trucks or buses, or else it will be damaged.

❗ Please use genuine discs, instead of incompatible and poor discs, or else it will damage the device or shorten the service life.

❗ Without the guide of qualified personnel, do not replace the fuse, or else it may damage the device or cause fire.

⚠ Please follow the traffic laws and regulations and do not watch program or operate the device when you are driving, to avoid accidents (excluding passengers watching through rear monitor).

❗ To ensure safety and operate the device normally, please ask qualified personnel to install the device. do not disassemble or repair the device without authorization, to avoid damage and accidents. Please contact local car audio distributor for details.

⊘ Do not put the device in moist environment or water, to avoid electric shock, damage and fire due to short circuit.

⊘ The mechanical drive part of the monitor uses automatic precision transmission component. Do not pull, push or rotate the device by force or impact the TFT screen to avoid damaging the device.

❗ Do not insert the audio plug of the vehicle into the master unit directly. please convert with the dedicated end cable provided by our company.

❗ When install the unit, prevent metal objects falling into the master unit from the vents to avoid short circuit and damaging the device.

Safety Statement

⊘ For the safety of you and others, do not watch programs or operate the device when you are driving. It is prohibited by the laws and regulations.

❗ The backing monitor function should be used as auxiliary means. we are not responsible for any accidents occurred during backing.

ACCESSORIES

Please note that when you buy this unit, you can find all the following parts in the gift box. And if not, please don't hesitate to contact us to get any of it.

Remote Control



GPS Antenna



RCA Cable



Power Cable

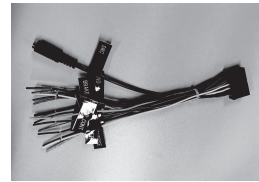

Mounting Brackets

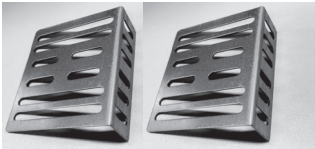

Mounting Hardware



Screw
CM5*6mm 8pcs

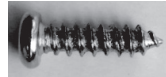

Screw
PA5*18mm 1pc



Spring Washer
1pc

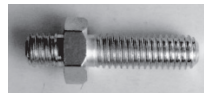

Rear Chassis
Support Bolt
M5x23mm 1pc

Trim Ring/Touch Pen



Rubber Support
Boot 1pc



Back installation
bracket

REMOTE CONTROL OPERATION

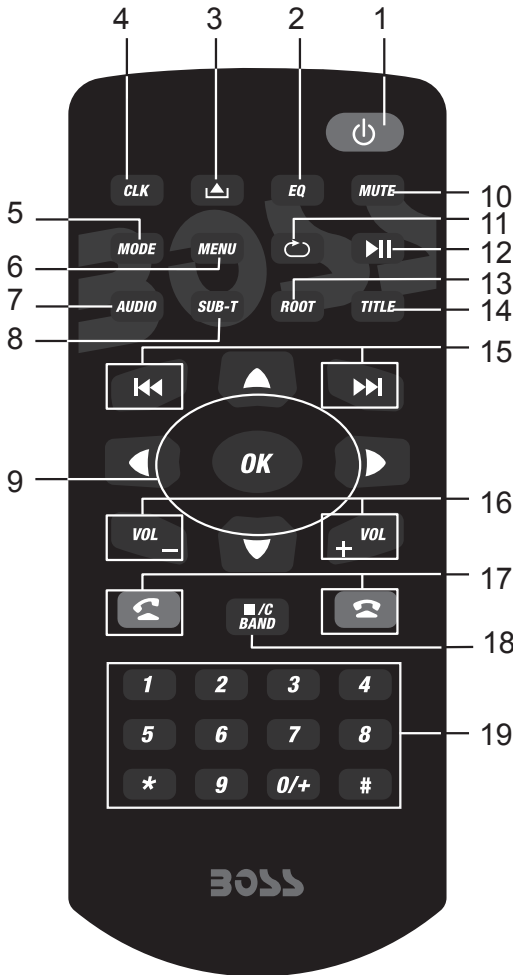

1.TURN ON/OFF

Press to turn on or turn off the unit.

2.EQ mode

Press to set EQ mode.

3.EJECT Key

Press to eject the Disc in the unit. And press again to load the Disc if you do not take out it.

4.CLK key

Press to show CLK, and press again back the last source.No working when video is playing.

5.MODE key

Press to change mode of the unit.

REMOTE CONTROL OPERATION

6.MENU key

Press Menu to return to the home menu.

7.Audio KEY

Press to change switch language in DVD mode, and switch left、right or stereo in VCD mode.

8.SUBTITLE Changing Key

Switch the subtitle during playing if the Disc have multiple subtitle.

9.Direction and OK key

If there is a Disc with root list menu,press direction key to move up/down/left/right, and press OK to confirm.

10.MUTE key

Press to mute the unit and press again to restore the volume.

11.REPEAT key

Under DISC/Music/Video mode, press to set the repeat mode.

12.Play/Pause

Press to switch play pause.

13.ROOT key

DVD playing mode, press to go into root list menu; VCD playing mode, press to turn on/off PBC function.

14.TITLE key

Under DVD playing mode, press to enter into title list menu.

15.Under Disc/music/video mode, press to choose previous/next song.

Under music list menu, press to choose PRE/NEXT music. Under RADIO mode, press to search frequency forward/backward.

16.VOLUME UP/DOWN key

Press to adjust volume up and volume down.

17.Receiving calls/call out; hang up.

18.STOP/C/BAND

In disc playing mode, press to STOP, press “ok” to start; In radio mode press to change band between FM1/FM2/FM3/AM1/AM2; Press to enter RADIO mode, except DVD mode.

Delete wrong number when in phone mode.

19.Number key

Enter phone number in phone mode.

UNIT INSTALLATION

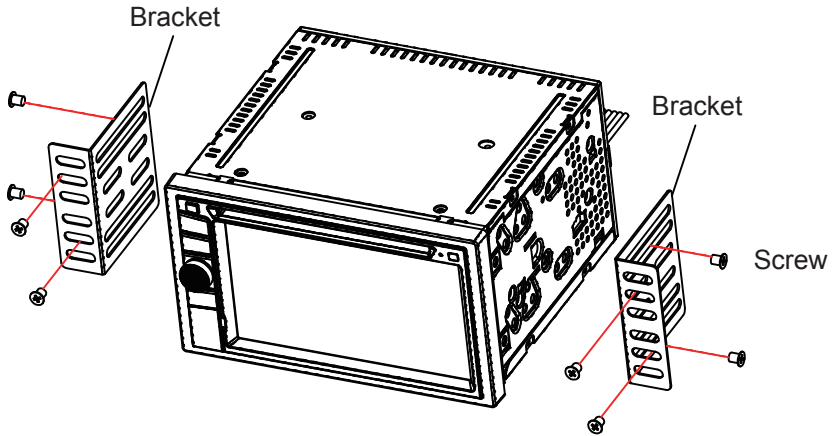

1. Put the 2 brackets to the left and right side of the unit;
2. Use screws to fix the brackets to the unit.
3. Once the screws are attached, the brackets can be adjusted forward or aft depending on the installation requirements.

PANEL INTRODUCTION

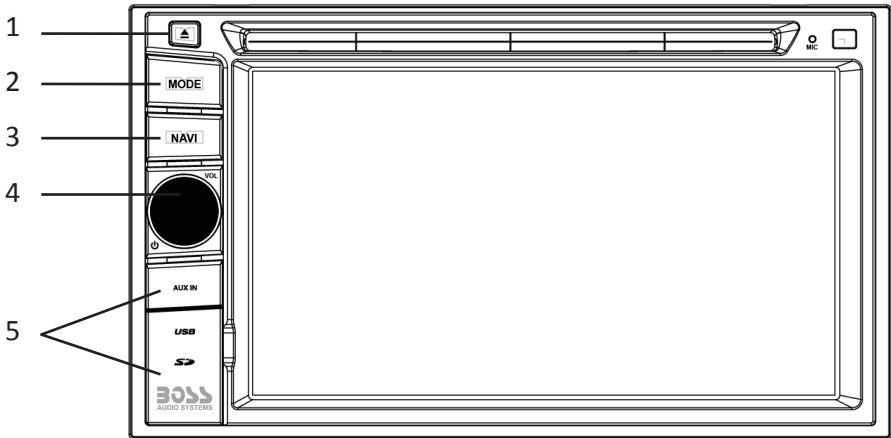

1.Eject key

When there is a Disc in the unit, press EJECT to remove the Disc. And press again to load the Disc if you do not take it out.

2.MODE key

Press to select system mode (RADIO/DISC/PHONE/VIDEOS/MUSIC/PICTURES/AUX IN/AV INPUT/CAMERA/NAVI)

3.NAVI key

Press to enter into GPS function, or back media from GPS.

4.TURN ON/OFF & VOLUME UP/DOWN

Long touch to turn ON/OFF the unit. Short touch to activate the MUTE function and silence the audio output. Touch again to restore sound. Rotate to adjust the output volume UP or DOWN.

5.Open to see GPS card slot, AUX IN jack, SD slot, USB port and reset key.

MAIN MENU OPERATION INSTRUCTION

MAIN MENU 1

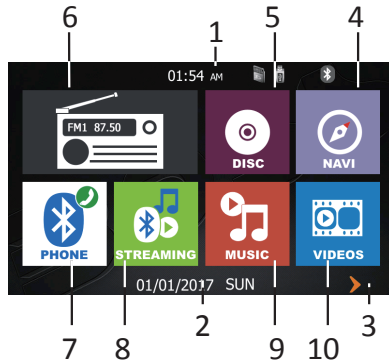

1. Shows the present time of the unit.
2. Shows the present date and week .
3. Press to go into main menu 2.
4. NAVI: Navigation Interface

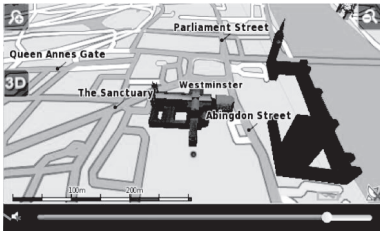

5. Disc Interface

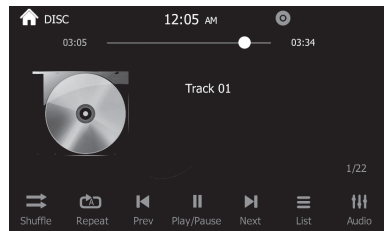

6. Radio Interface

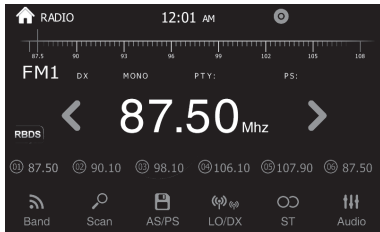

7. Phone setup Interface

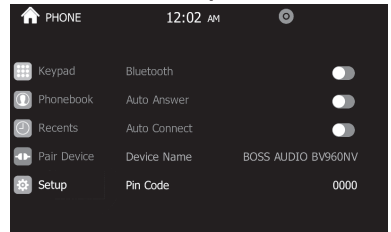

8. BT Music Interface

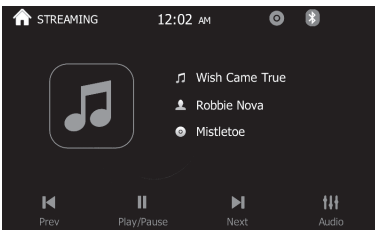

9. Music Interface

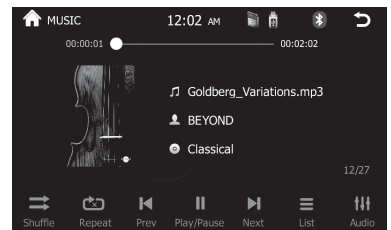

MAIN MENU OPERATION INSTRUCTION

MAIN MENU 2

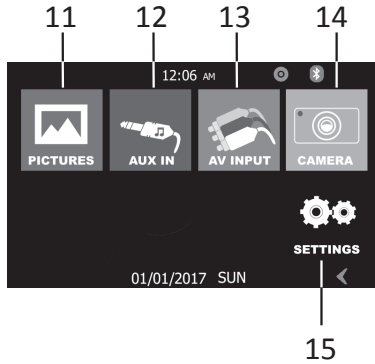

10. Video Interface



11. Picture Interface



12. AUX Interface

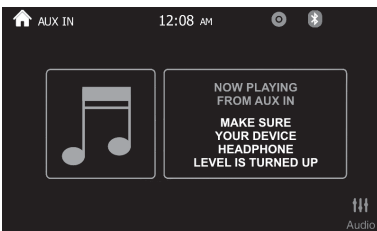

13. AV no signal Interface

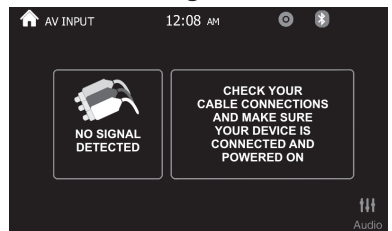

14. Camera Interface

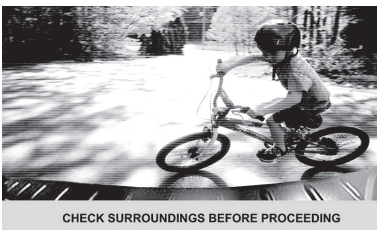

15. Settings Interface

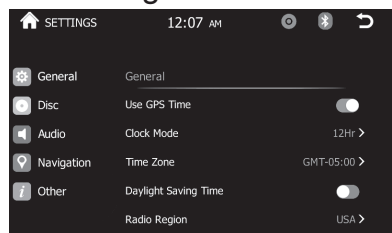

ACCESS SETUP INTERFACE

There are five menu in setup:

GENERAL SETUP—Menu 1

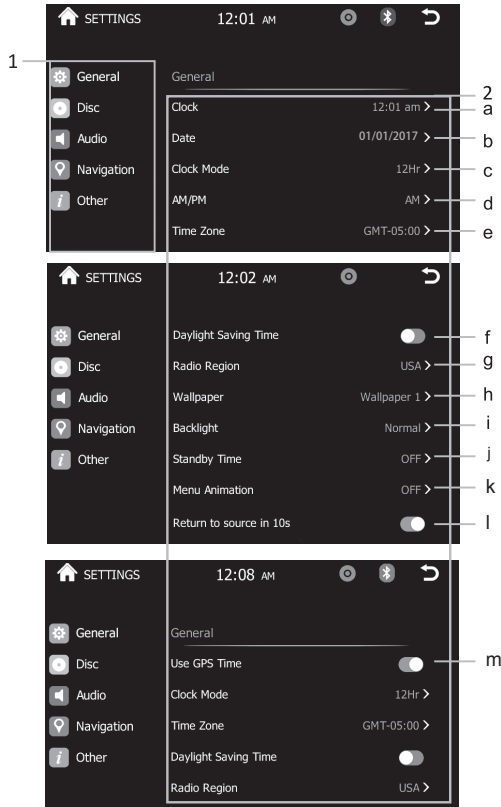

1. Setup function area: General setup, Disc setup, Audio setup, Navigation setup, Other setup.
2. Subsidiary function area: Move up and down to see the general setup items.
 - a. Touch to setup the present time.
 - b. Touch to set present date
 - c. Touch to set clock mode: 24/12 hr
 - d. Touch to set AM/PM at 12 hr mode.
 - e. Choose time zone according to your local place.
 - f. Choose daylight savings ON/OFF according your local place time.
 - g. Touch to choose radio field between: USA/Europe/Latin1/Latin2/ORIT/China/Japan/korea.
 - h. Touch to set wallpaper as you want from the 5 wallpapers storage of the system.

ACCESS SETUP INTERFACE

- i. Backlight dimmer selection: Night/Dark/Normal/Bright.
- j. Go sleep time selection: OFF/One minute/Five minute/Ten minute.
- k. Switch effect selection: Left-right/Right-left/Top-bottom/bottom-top /big-small/Small-big/Gradient/Random/Off.
- l. Turn it ON, it will go back from main menu to the latest playing mode in 10 seconds if you do not operate.
- m. Use GPS Time:
When "USE GPS TIME" turn on, DVD time sync GPS time;
When "USE GPS TIME" turn off, DVD time not sync GPS time;

NOTE:

Move up and you will see some other setup subsidiary functions.

DISC SETUP -Menu 2

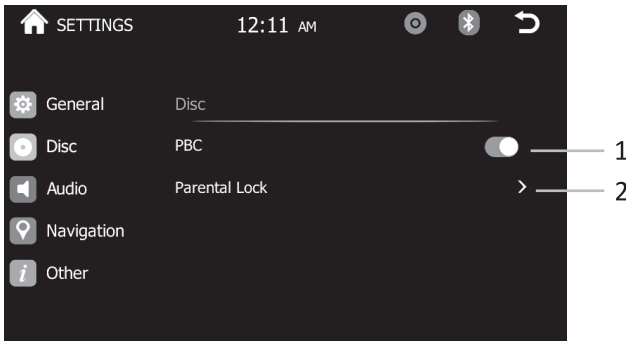

- 1. Touch to turn on or turn off the VCD PBC function.
- 2. Touch to set up the level of the DVD. Default password is 000000.

AUDIO SETUP -Menu 3

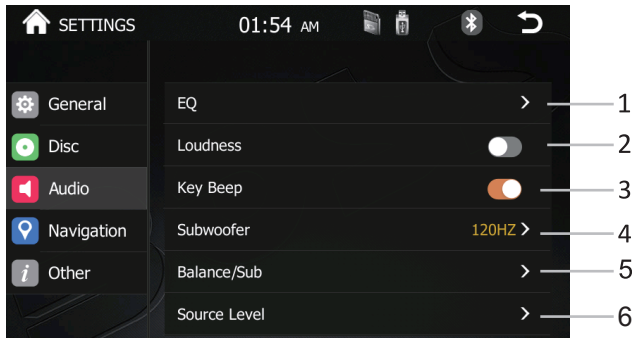

ACCESS SETUP INTERFACE

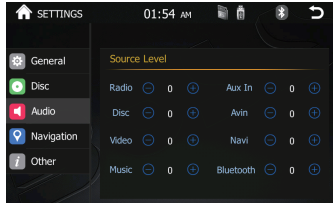
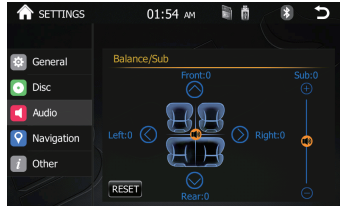
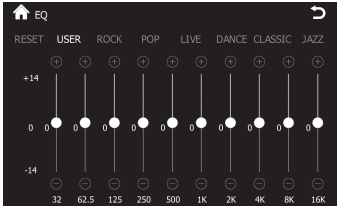

1. Press to enter into EQ set up menu.
2. Loudness: ON/OFF.
3. Beep sound: ON/OFF.
4. Subwoofer selection: OFF/80HZ/120HZ/160HZ.
5. Balance/Sub: You can adjust the speaker volume by adjusting the front and back, left and right column; And subwoofer level control.
6. Source Level: the source mode gain control

NAVIGATION SETUP -Menu 4

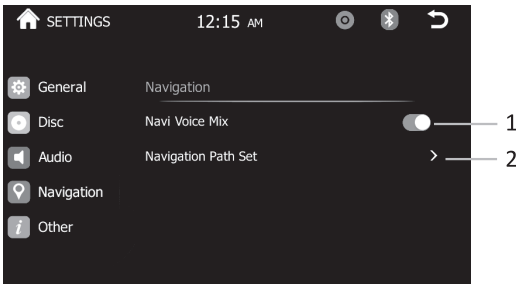

1. Turn on or turn off the navigation voice mix function. Turn on, once report navigation information and also have audio source play. Turn off, there is only navigation voice.

2. Press to go into navigation path setup menu:

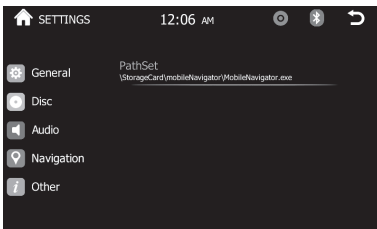

It will show the usable navigation program and choose to set as the running program.

SWC-STEERING WHEEL CONTROL SETTING

OTHER SETUP -Menu 5

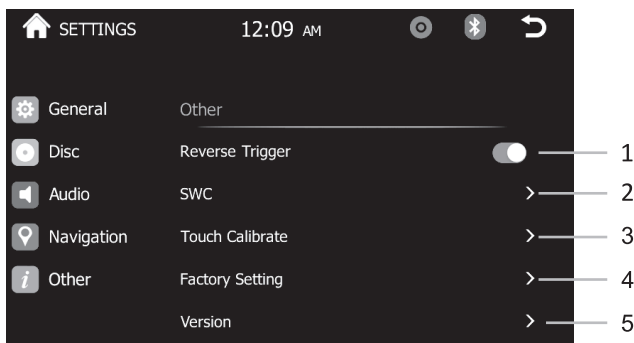

- 1.Reverse trigger: Turn on if you have a rear view camera.Turn off if you haven't.
- 2.Touch to enter swc menu.
- 3.Touch to enter calibrate menu.
- 4.Load factory setting.
- 5.Touch to see the software version of the unit.

SWC-STEERING WHEEL CONTROL SETTING

Touch SWC enter SWC setting menu:

Press"OK"to start SWC learning.

Start learning:

Set the POWER button as an example.

- 1.Press POWER button in the unit(Picture 1) ,then you will see reminder like picture 2, Press OK.
- 2.Press POWER key in your steering wheel. Then you can see the reminder in the unit like Picture .Setting successfully. Will show like Picture 3.
- 3.Click OK, and finished learning.
- 4.Repeat 1-3 to learning other keys.

Picture 1

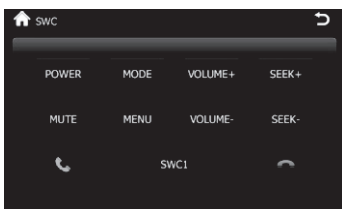

Picture 2



RADIO OPERATION

Picture 3



SWC1: Select different SWC resistance to meet different cars. If you cannot finish all key pairing, you can press to select SWC2 SWC3, until all keys can learn. NOTE: Click SWC1 you will lost all KEY learning before.

RADIO OPERATION

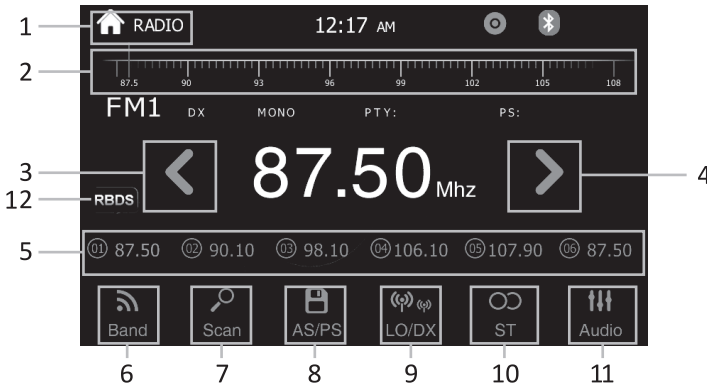

1. Show the present mode. Touch to go back home.
2. Click to choose the frequency.
3. Short press to seek backward. Long press to enter manual mode and backward in step.
4. Short press to seek forward. Long press to enter manual mode and forward in step.
5. Preset stations area, long press to save current station.
6. Band changing: Click to change band between FM1/FM2/FM3/AM1/AM2.
7. Search the stations, play the searched one for 5S and go on to search next one and repeat this.
8. Change between AS and PS.
9. LO/DX: Touch to select Local or Distant broadcasting stations.
10. Stereo on/off: Click to turn on/off stereo when receiving a stereo signal.
11. Audio: Press to set the audio effect.

12. RBDS: Touch to enter RBDS setup menu. you can choose the program type you like to listen: news, sports ,inform, etc.

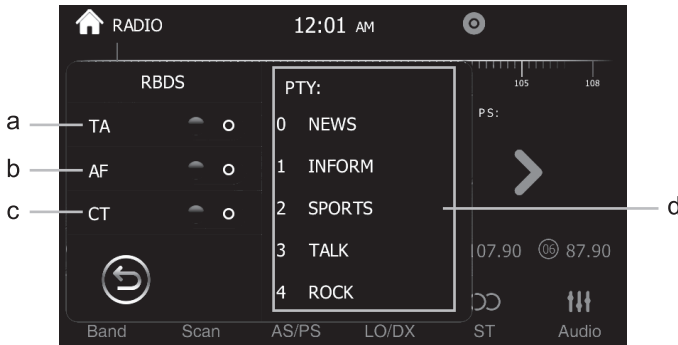

a. TA(Traffic Announcement)

ON: When the traffic station is turned on, the radio will automatically search for traffic stations. After a station is searched, screen displays “TP” Only when traffic information is broadcasted can it be received, after traffic information is completed, the radio will automatically switch to the previous mode.

OFF: Repress [TA] button to close TA function. In other modes, traffic announcement will automatically switch to radio mode, after the traffic announcement is completed, it will automatically switch to the previous mode.

b. AF(Auto Frequency)

Touch the button to turn the AF function on/off. AF function is turned on, When the received station signals become weak, the radio will automatically fine-tune to other frequencies. When receiving an emergency announcing, the screen will display warning message.

c. CT (Clock Time)

To provide current time correction information, the RBDS station can automatically correct the system clock of the receiver when the clock RBDS is opened.

d. PTY(Programming Type)

Touch the button the screen displays program types, users can search station according to program type.

Note: If RBDS is turned OFF, AF/TA/PTY will not function.

DISC PLAYBACK-VIDEO



1. Icon gray mean disc loaded.
2. Function Area: show the process and time of the present video. This bar will disappear in a while, and click this area to show this function bar again. Touch the bar to set the playing time.
3. Click to show the information of present video.
4. Function bar same as audio playing menu. Press the function key and you will see the following to choose chapter:

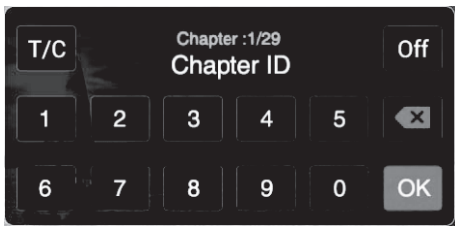

Click the relevant key to choose the chapter

NOTE: When properly installed, a video cannot be displayed unless the parking brake is applied. If the parking brake wire is not installed correctly, the following message will appear.

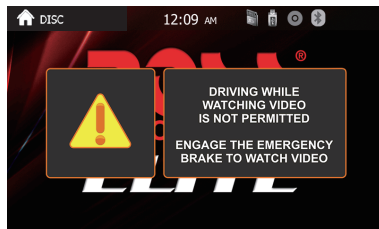

DISC PLAYBACK-AUDIO

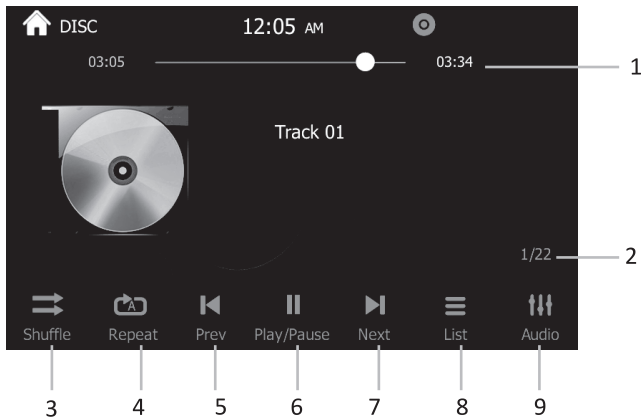

- 1.Total time of the playing song.
- 2.Present playing one/total music numbers.
- 3.Random play.
- 4.Loop playback.(ALL/SINGLE loop play).
- 5.PREV: Press to choose previous music.
- 6.PLAY/PAUSE: Touch to begin playing. And press the icon again to pause playing.
- 7.NEXT ONE: Press to choose next music.
- 8.Click to see the music play list menu. And user's can choose which one to play here.

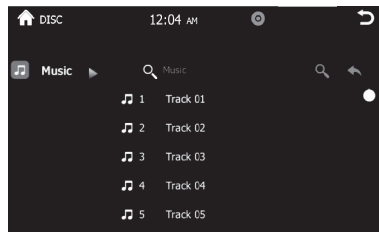

- 9.Press to going into EQ setting interface:

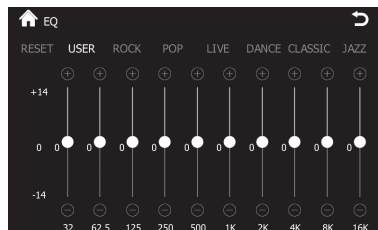

BLUETOOTH OPERATION

MUSIC PLAYING MENU

Press MUSIC in the main menu, it refers to the music file from SD and USB.

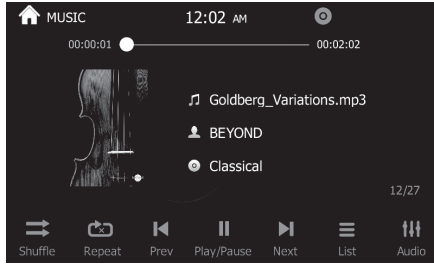

BLUETOOTH OPERATION MENU

Click phone icon and will enter into Bluetooth function interface:

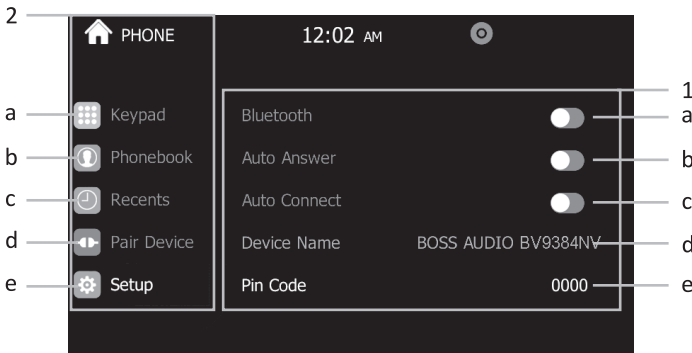

1. Bluetooth setting menu:

a. ON/OFF: Turn on and turn off of Bluetooth when not using.

Turn on: show gray BT  and the icon turn blue when paired phone.

b. Answer automatically: Can turn on or turn off the function of listen to calls automatically.

c. Connect automatically: Can connect the devices automatically which have already been connected before .

d. Default Bluetooth name for this unit: BOSS AUDIO BV9384NV

e. PIN code: Default password "0000" , and can be change by yourself click "0000"

BLUETOOTH OPERATION

2.Function area:

- a.Click and see the dialing keypad, users can dial no. and make phone calls.
- b.Click to see the Bluetooth phonebook menu.
- c.Click to see the Bluetooth call history.
- d.Bluetooth pairing interface as following:

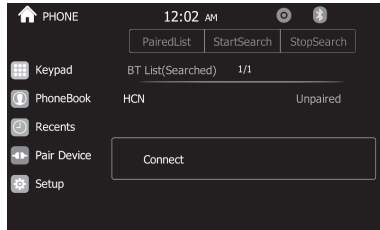

e.Bluetooth setting menu.

BLUETOOTH DIALING



- 1.Shows the number you press in,and press  to delete wrong number.
- 2.Key area.
- 3.Touch to call out.

BLUETOOTH OPERATION

BLUETOOTH CALL

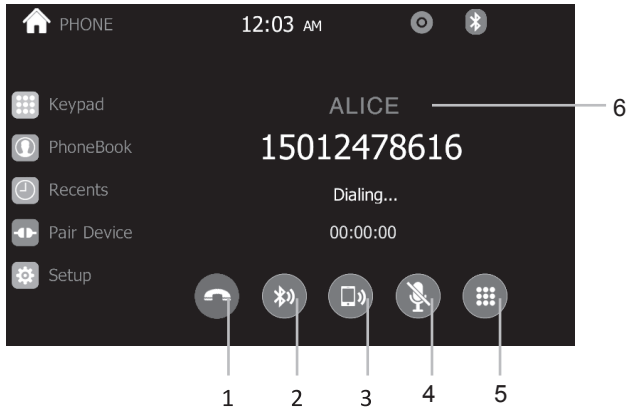

1. Press to hang up the phone call.
2. Touch to talk through Bluetooth.
3. Touch to talk through cellphone.
4. Touch to mute mic
5. Touch to get keypad.
6. Show contact name.

BLUETOOTH PHONE BOOK

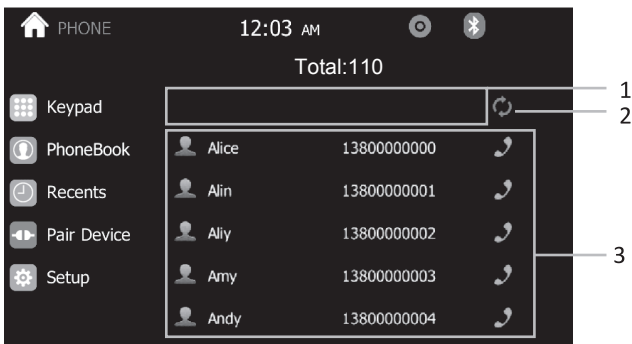

BLUETOOTH OPERATION

1.Touch to enter name and search the wanted phone number.

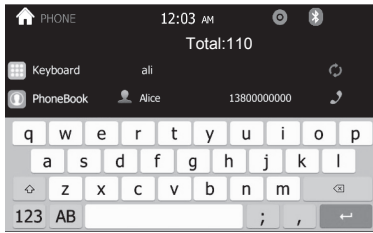

2.Click to sync phonebook.

3.Contact list.

BLUETOOTH PHONE CALL HISTORY

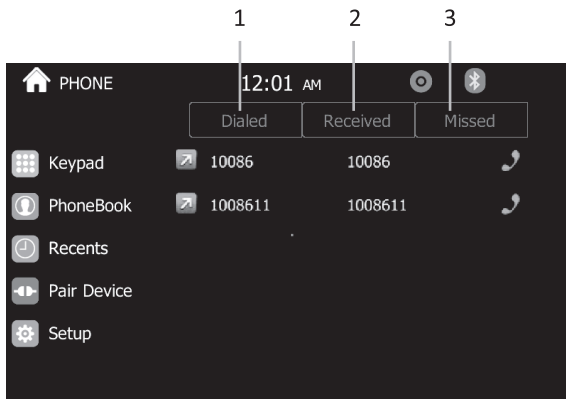

1.Touch to show the dialed phone number.

2.Touch to show the received phone number.

3.Touch to show missed calls.

PHOTOS

BLUETOOTH MUSIC-A2DP

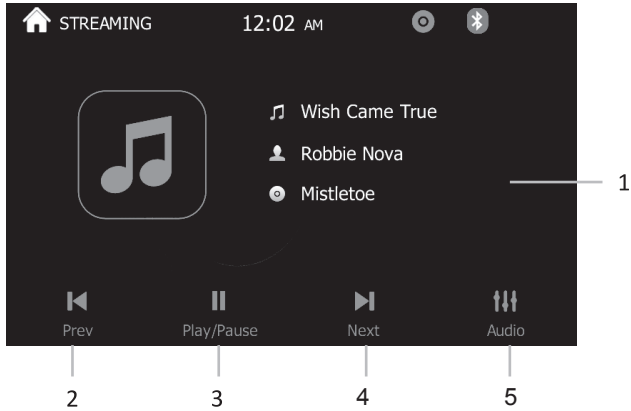

1. Show playing song name and ID3
2. Previous song
3. Play/pause.
4. Next song
5. Enter EQ setting menu.

PICTURE



1. Press to turn to the previous picture.
2. Press to turn to the next picture.
3. PLAY/PAUSE: touch to begin play. Press again the icon to pause. During picture playing mode, one picture will be played for 5s automatically and goes to the next if you do not press it.
4. Zoom out the present picture.
5. Zoom in the present picture.
6. Turn left 90 degrees.
7. Turn right 90 degrees.
8. Press to tailor the picture as you want. Touch and drag the corner to decide the picture and press , you can set the picture as the background of the unit. And this background will remain the same till you reset it.

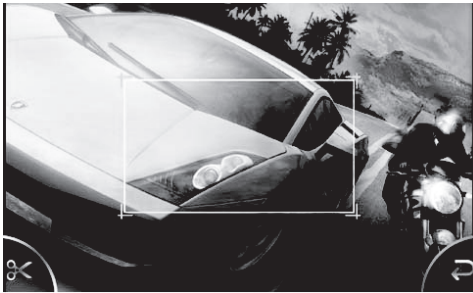

9. Press to see the picture list:

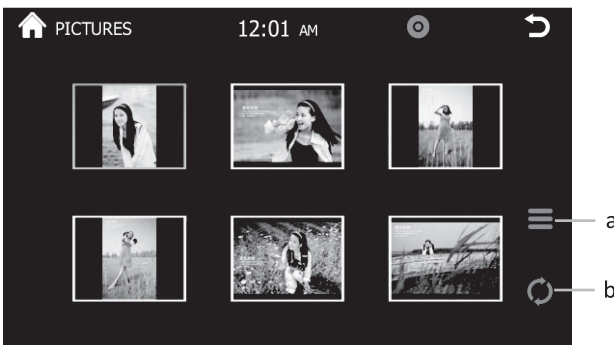

- a. Touch to change between picture mode and picture list mode.
- b. Scan the picture file of your SD or USB.

CAMERA/AUX/AV MENU

CAMERA: Rear view function, the rear view video signal can display automatically when you reversing the car, and back to the last sources after reversing the car.



AUX IN: External audio input function

Connect the audio device to the unit by the 3.5mm jack in front of the panel and touch AUX INPUT icon.

AV INPUT: External video and audio input function

Connect the video and audio device to the unit by the RCA jacks and touch AV INPUT icon.

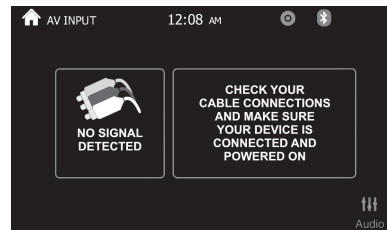
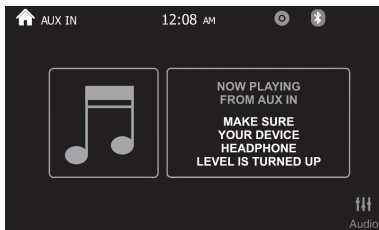

TROUBLESHOOTING

Table 1: Error message

Media displayed	Cause	Corrective Action
Loading	Disc is being read	
No Disc/Bad Disc	Disc is dirty	Clean the disc
	Disc is upside down	Insert Disc in right way
Unknown Disc	Unsupported Disc type	Check the disc and change one
Error	Illegal mechanism operation	Press EJECT for 5s to reset loading mechanism

Table 2:General problems

Problem	Cause	Corrective Action
Unit will not power on	Radio fuse blown	Install new fuse with right rating
	Car battery fuse blown	Install new fuse with right rating
	Illegal operation	Press the RESET button
Screen touch is insensitive	Place of touch screen is offset	Go to setup menu and set the calibration
No audio output	Improper audio output connection	Check wiring and correct
	VOLUME 0	Turn up the volume
	Improper MUTE connection	Check wiring and TEL MUTE connection
	Speaker damaged	Change speakers
Low audio output	Volume set too low	Increase the volume
	Heavily biased volume balance	Check and adjust the channel balance to the center position

TROUBLESHOOTING

Poor sound quality or distortion	Speaker power rating not compatible with unit	Connect proper speakers
	Speaker is shorted	Check speaker contrast
No GPS image	Image has not been changed to GPS system	Change to GPS system

Table 3: TFT monitors

Problem	Cause	Corrective Action
No image	Incorrect connection to parking wire	Check wiring and correct
	Parking brake is not engaged	Stop vehicle in safe place and set parking brake ON
Flashing image or interference appears on screen	DVD is not compatible with current TV system settings	Change setup to accommodate Disc
	Improper video signal connections	Check wiring and correct
Improper image, improper height/width ratio display	Improper aspect ratio setup	Use correct aspect ratio setting

Table 4: Tuner

Problem	Cause	Corrective Action
Weak station searching	Auto antenna is not fully extended	Connect the auto antenna properly
	LOCAL function is activated	Turn LOCAL function OFF

USER'S MANUAL

BV9384NV

BLUETOOTH® | BUILT-IN NAVIGATION | DVD/MP3/CD AM/FM RECEIVER



BOSS Audio Systems
3451 Lunar Court • Oxnard, CA 93030

www.bossaudio.com

800-999-1236 US Toll-free

805-751-4853 Customer Service

Tech Support: www.bossaudio.com/support/technical-support



0417

iPod® and iPhone® are trademarks of Apple, Inc. registered in the U.S. and other countries. BOSS Audio Systems is not affiliated with Apple, Inc. The Bluetooth® word mark and logos are registered trademarks owned by Bluetooth SIG, Inc. and any use of such marks by BOSS Audio Systems is under license. Other trademarks and trade names are those of their respective owners.