

31 Gauge Galvanized Steel · 8 in. x 50 ft.

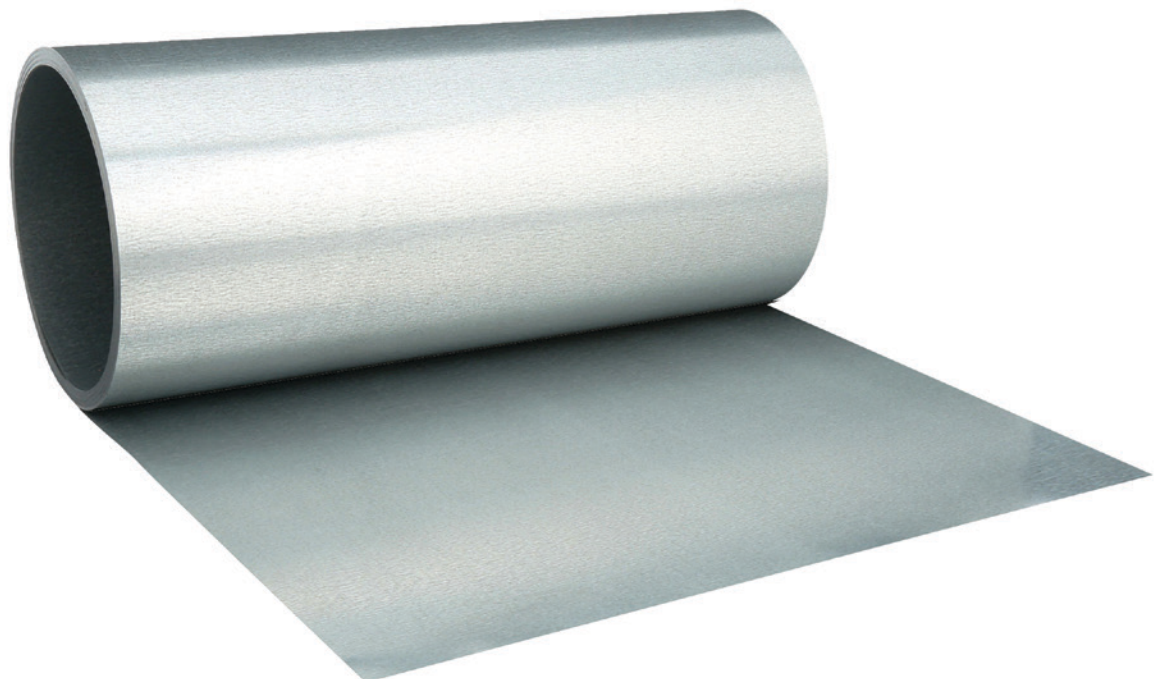
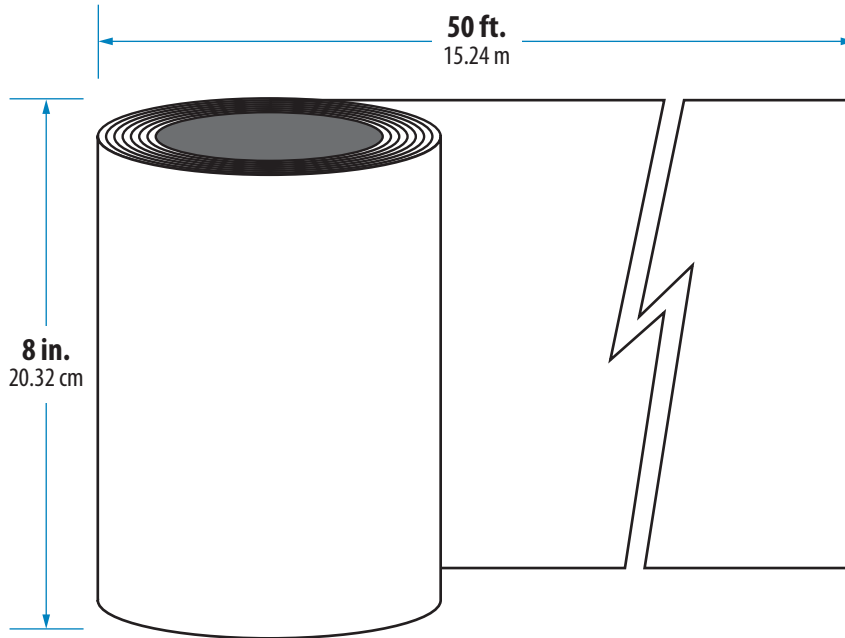

Mill Finish