

WOODPLAY[®]

Playsets

UPPER ENCLOSURE Assembly Instructions

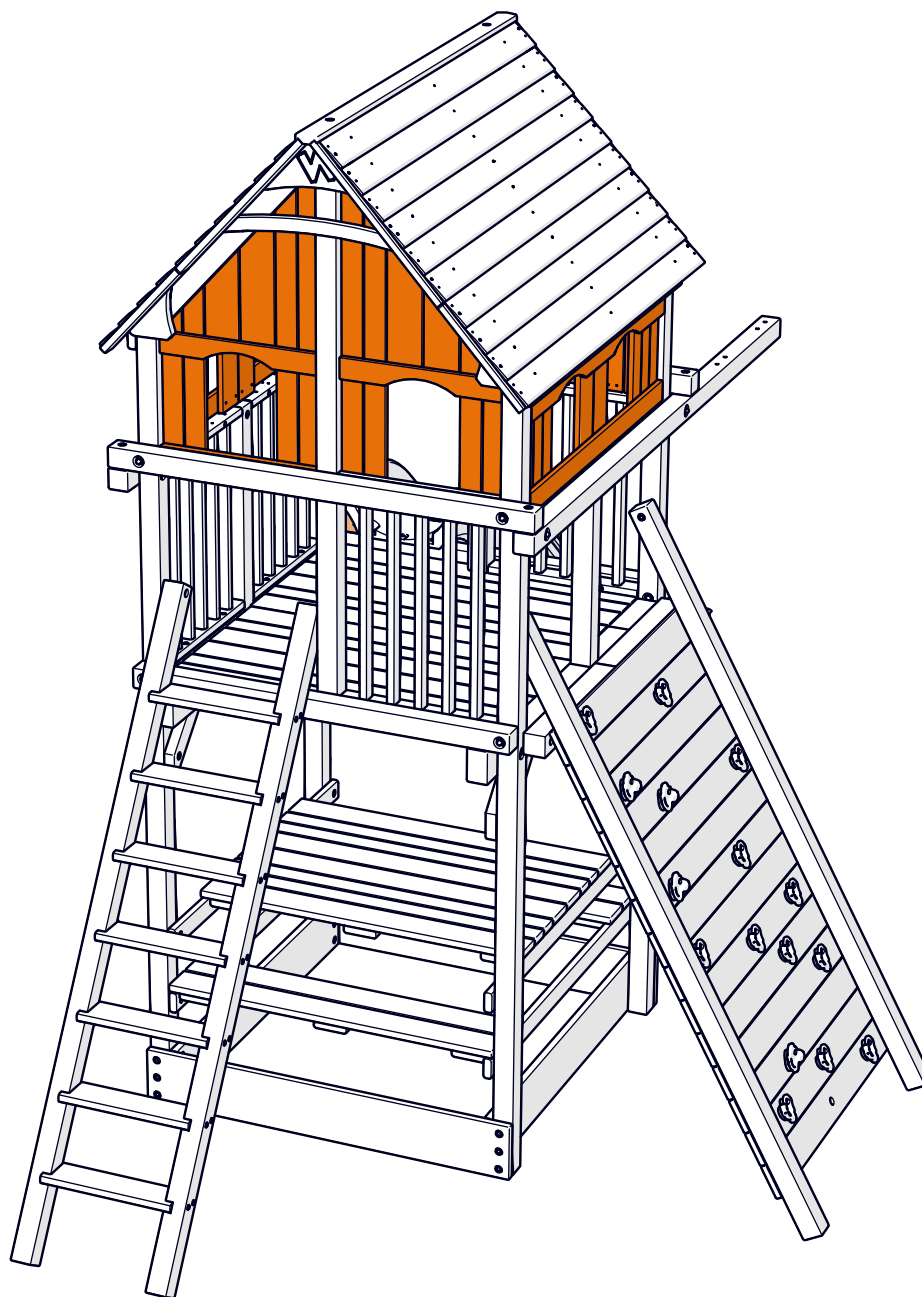

PG-MAN-ENC-PH-00

STANDARD PARTS LIST

NOTE: Parts will have the part number (Starts with PG-) stamped on the part itself.



Right Inside Enclosure Board
PG-ENC-051-RI
QTY. 2

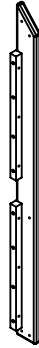

Left Inside Enclosure Board
PG-ENC-051-LI
QTY. 2



Right Outside Enclosure Board
PG-ENC-027-RO
QTY. 2



Left Outside Enclosure Board
PG-ENC-027-LO
QTY. 2

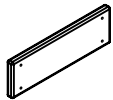

Enclosure Board
PG-546-017-ENC
QTY. 4

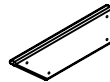

17 1/2" Enclosure Board
PG-546-018-ENC
QTY. 2

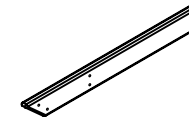

30 5/8" Enclosure Board
PG-544-031-ENC
QTY. 4

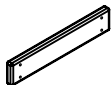

Enclosure Board
PG-544-017-ENC
QTY. 8



Window Bottom
PG-2X4-025-WB
QTY. 3

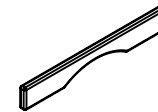

Window Top
PG-544-025-WT
QTY. 4

STANDARD PARTS LIST

NOTE: Parts will have the part number (Starts with PG-) stamped on the part itself.

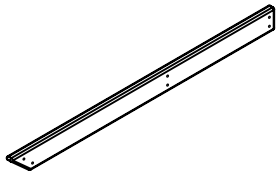

47" Enclosure Board
PG-544-047-ENC-B
QTY. 4

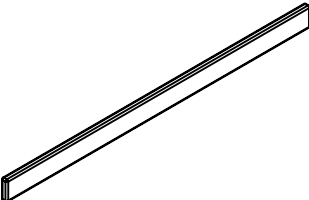

Window Bottom Filler
PG-544-054-ENC
QTY. 2

TOOLS NEEDED FOR ASSEMBLY

 Tape Measure	 Cordless Drill	 Phillips #2 Bit
---	---	--

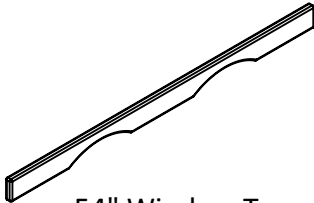

54" Window Top
PG-544-054-WT
QTY. 2

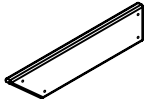



Enclosure Board Short
PG-546-024-ENC
QTY. 4



Side Outside Enclosure Board
PG-ENC-017-SO
QTY. 4

HARDWARE NEEDED (ACTUAL SIZE)

#10 X 3" PHILLIPS FLAT HEAD WOODSCREW PG-HW-S011 QTY. 48

#10 X 1-3/4" Flat Head Screw PG-HW-S018 QTY. 176

NOTE

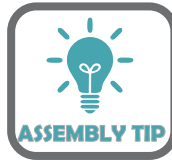
COMPLETE ASSEMBLY OF YOUR PLAYSET & WOOD ROOF BEFORE ADDING THIS UPPER ENCLOSURE.



Parts will have the part number (Starts with PG-) stamped on the part itself.

HARDWARE NEEDED (ACTUAL SIZE)

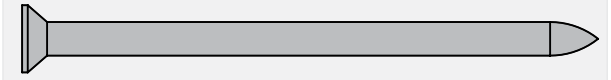

#10 X 3" PHILLIPS FLAT HEAD WOODSCREW
PG-HW-S011
QTY. 18

1. Attach PG-ENC-051-RI & PG-ENC-51-LI to Vertical roof support with six screws each as shown in **Inside View**. Line up both parts to Vertical Roof Support and Safety Rail as shown in **Detail A**.

2. Attach PG-ENC-027-RO & PG-ENC-027-LO to Corner posts. See **Inside View**.

INSIDE VIEW

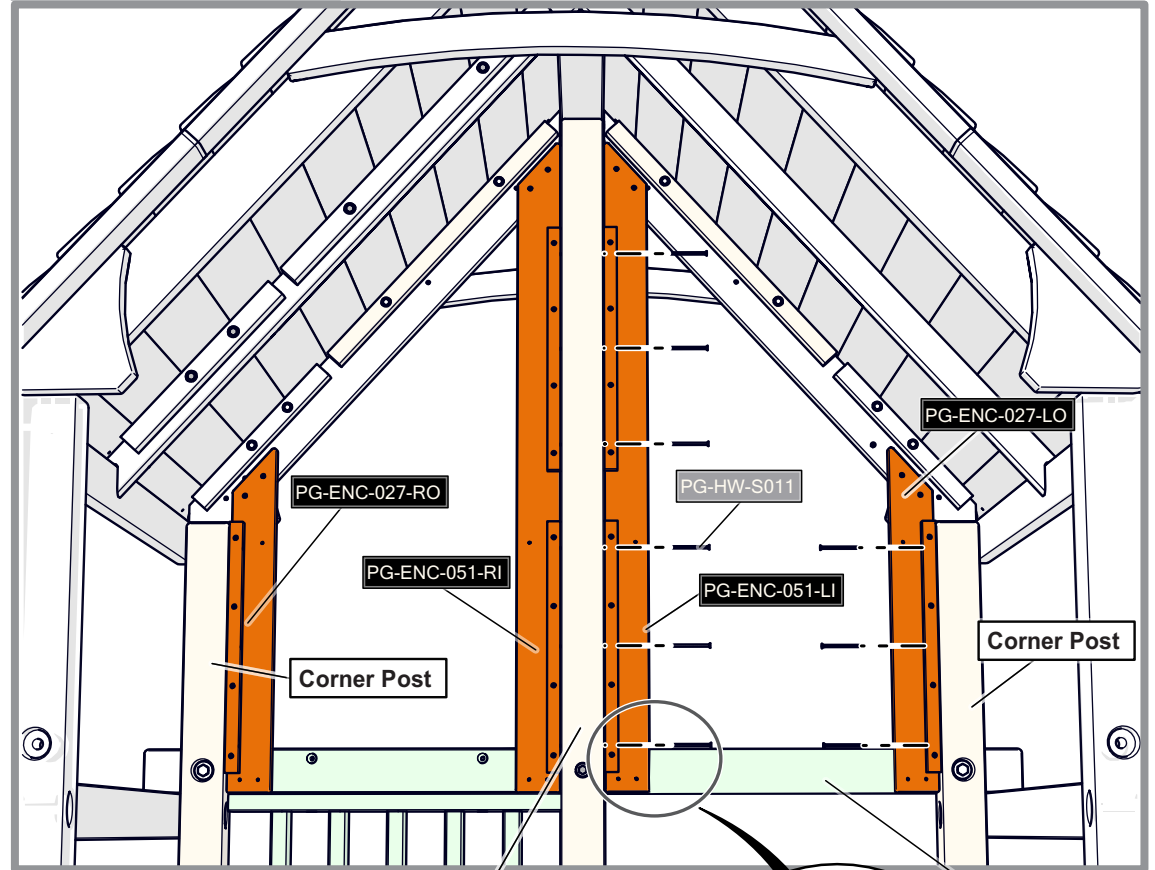

DETAIL A

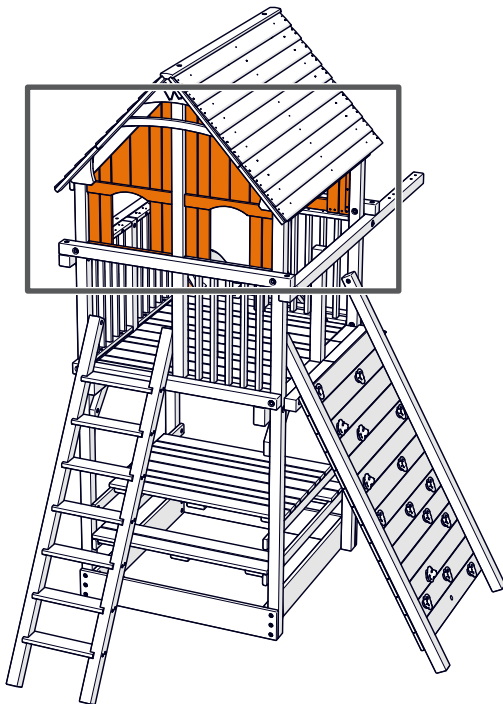
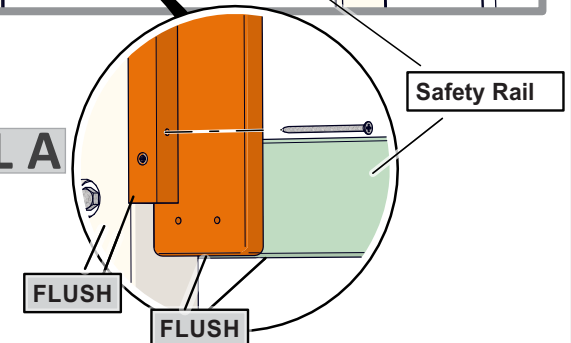

HARDWARE NEEDED (ACTUAL SIZE)

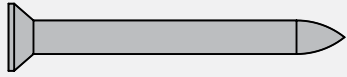

#10 X 1-3/4" Flat Head Screw
PG-HW-S018
QTY. 8

3. Attach each part to the Rafter at the top with two **PG-HW-S018** screws as shown in the **Inside view** and **Detail B**.

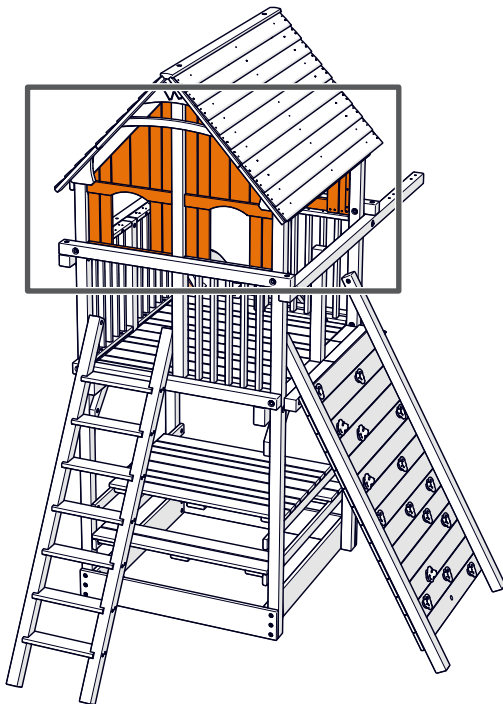
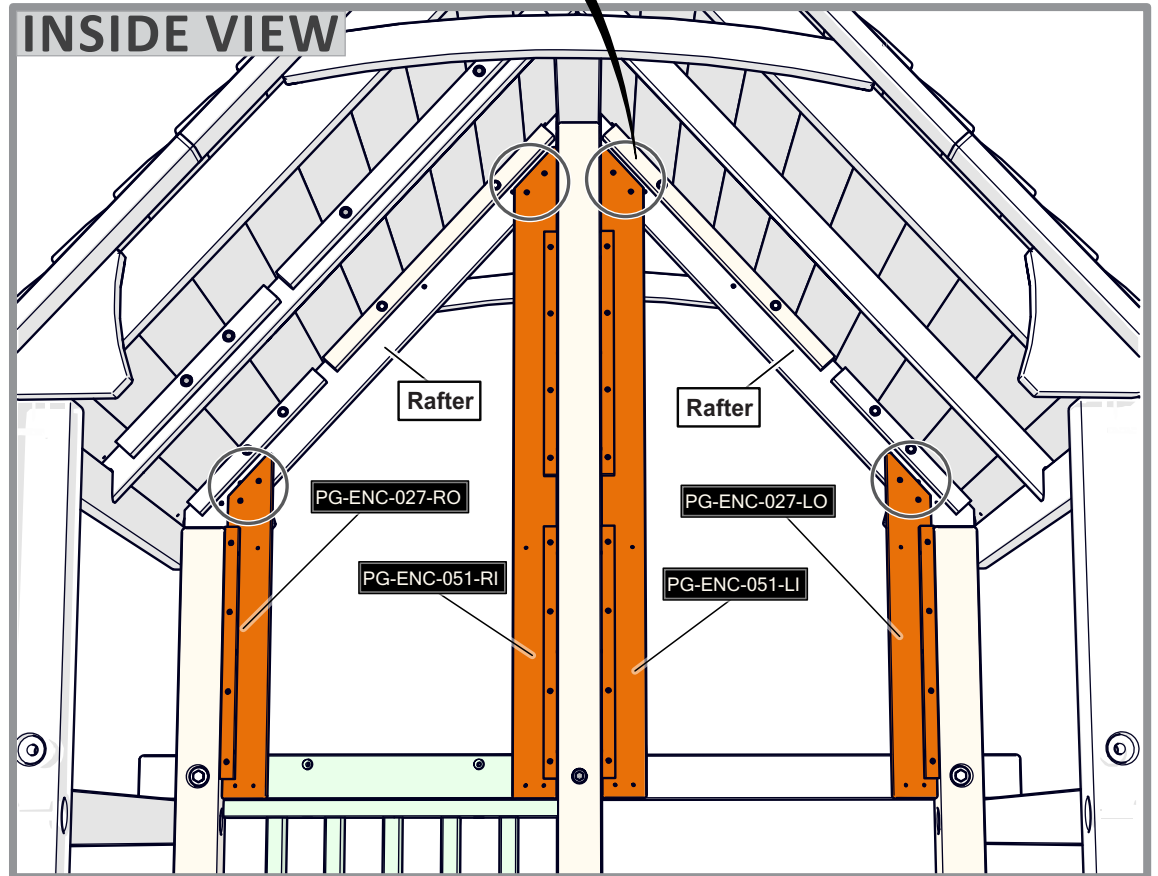
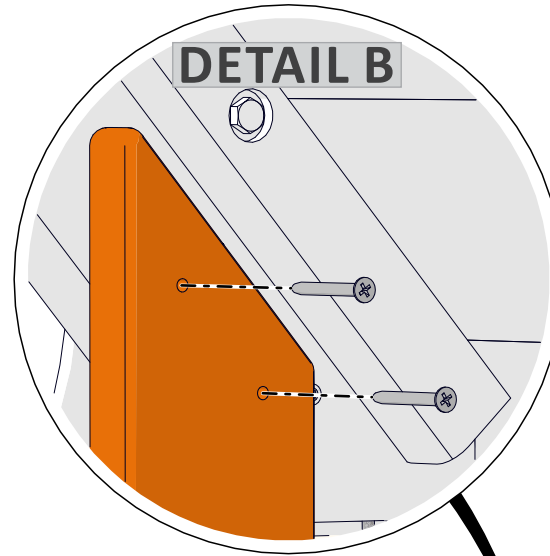

HARDWARE NEEDED (ACTUAL SIZE)

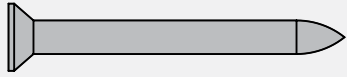

#10 X 1-3/4" Flat Head Screw
PG-HW-S018
QTY. 12

4. Attach two **PG-544-025-WT** with one screw on each end as shown in the **Inside View & Outside View**. Line up the boards flush as shown in **Detail C**.
5. Attach two **PG-2x4-025-WB** boards with two screws on each end in the **Inside View**. Line up the boards flush as shown in **Detail D**.

INSIDE VIEW

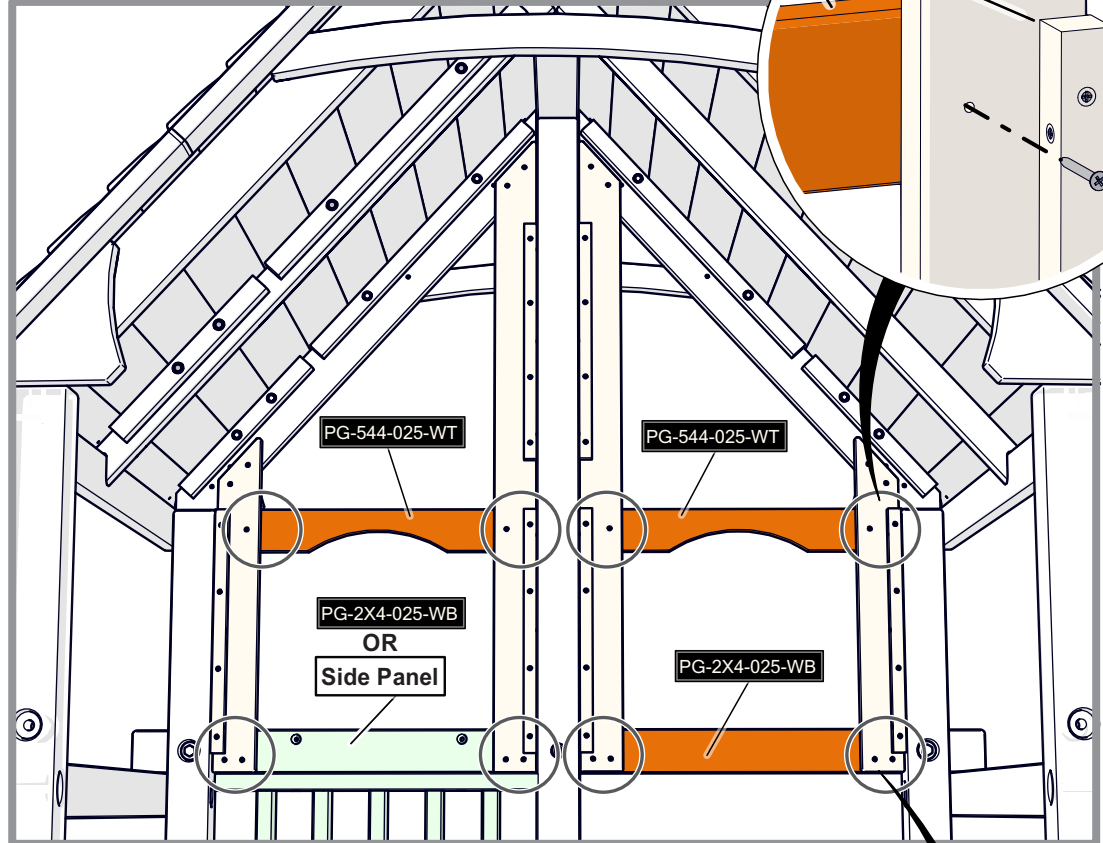

If you have a **Side Panel** installed, a **PG-2X4-025-WB** board is not needed for that opening.

OUTSIDE VIEW

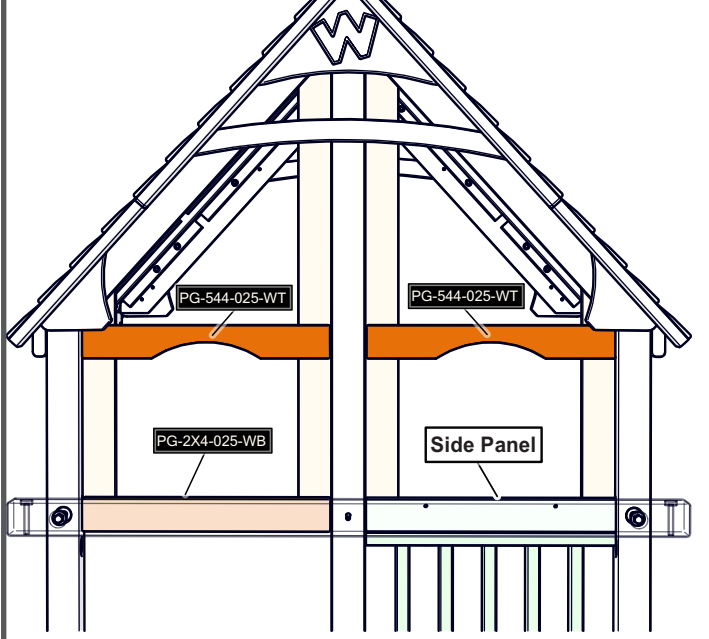

DETAIL C

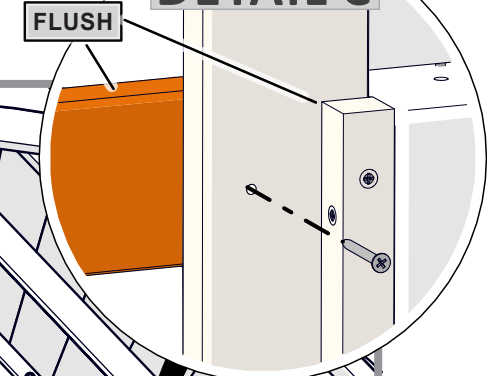

DETAIL D

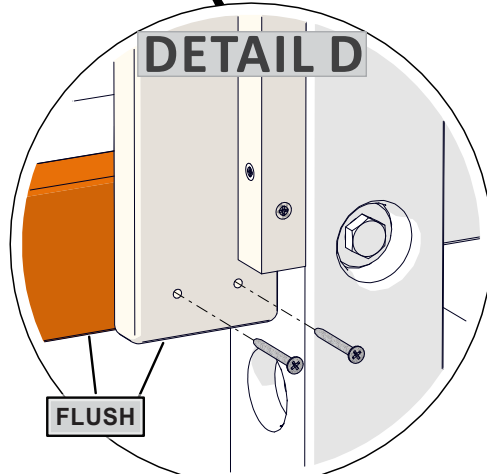

HARDWARE NEEDED (ACTUAL SIZE)

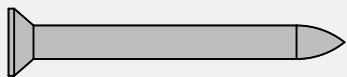

#10 X 1-3/4" Flat Head Screw
PG-HW-S018
QTY. 40

6. Attach boards as shown in the **Inside View** & **Outside View**. Space boards evenly and fasten with **PG-HW-S018** screws.

7. Repeat Steps 1-6 on other end to enclose the back part of the playset.

INSIDE VIEW

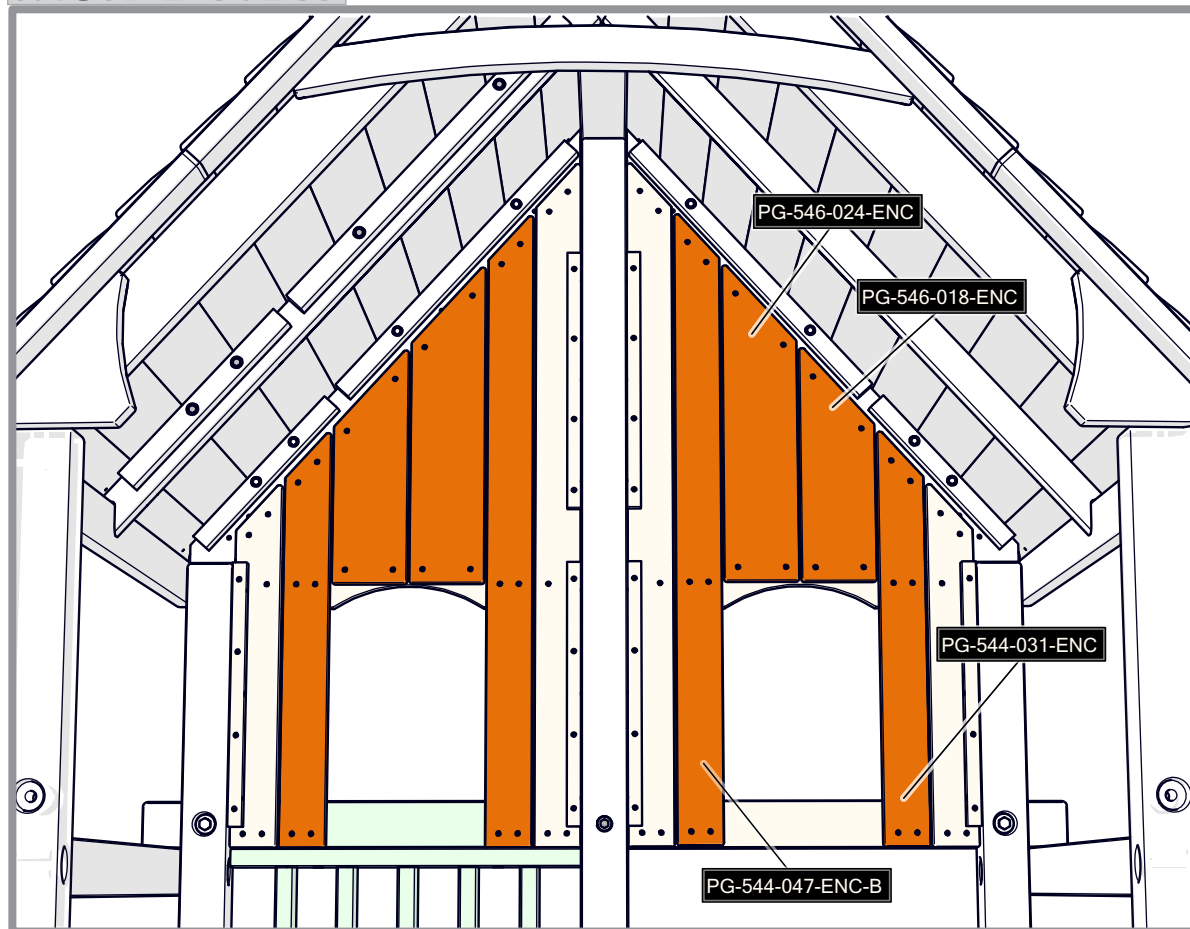

OUTSIDE VIEW

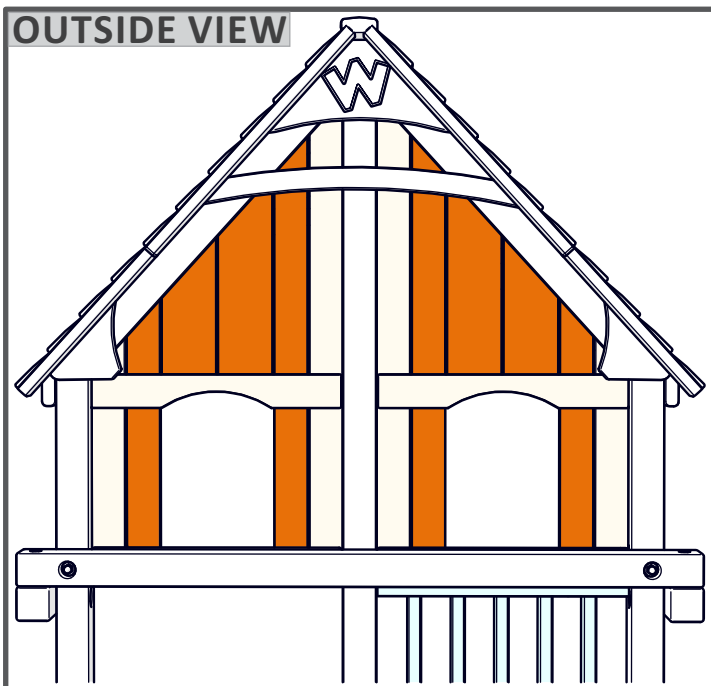

HARDWARE NEEDED (ACTUAL SIZE)

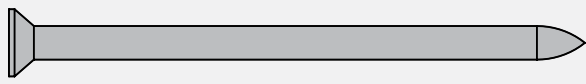

#10 X 3" PHILLIPS FLAT HEAD WOODSCREW
PG-HW-S011
QTY. 6

8. Offset PG-ENC-017-SO board assemblies **1 inch** from the outside of the Corner Posts as shown in **Detail E**.
9. Attach PG-ENC-017-SO assemblies to Corner Posts making sure to line up Board flush to the Safety Rail. See **Inside View**.



INSIDE VIEW

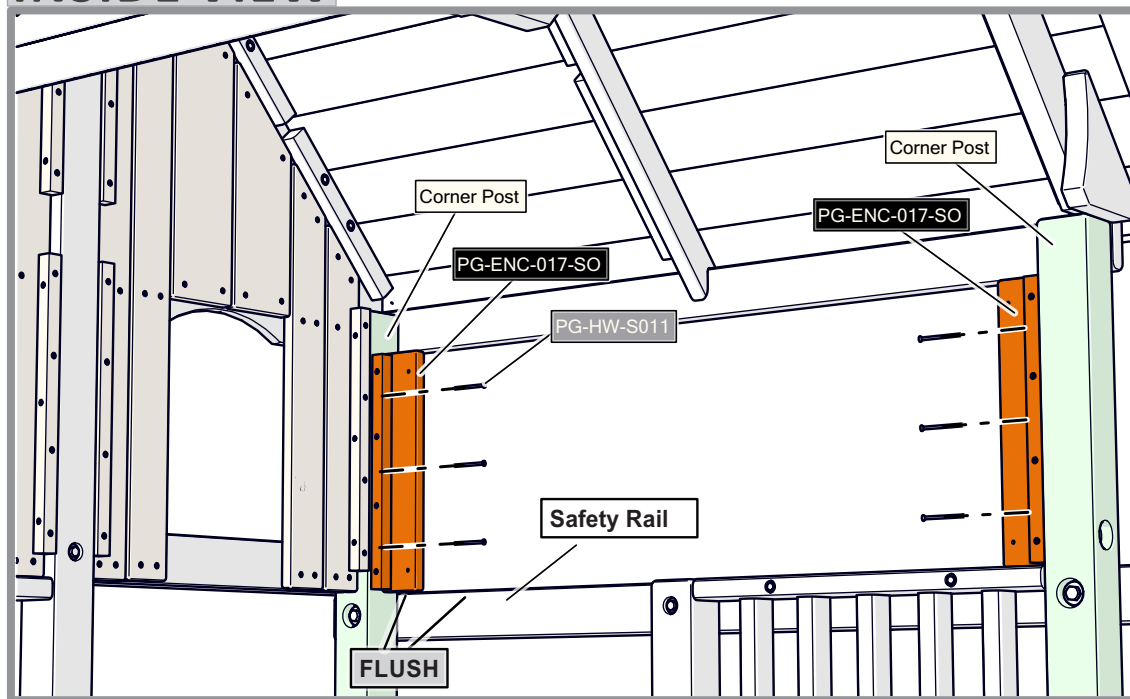

DETAIL E

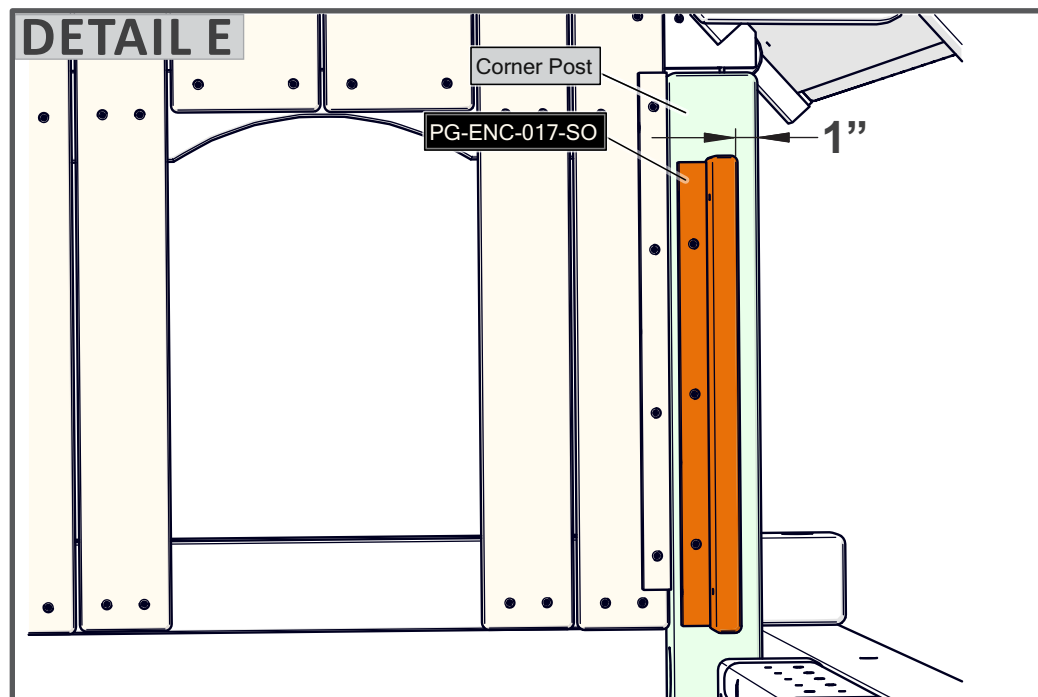

HARDWARE NEEDED (ACTUAL SIZE)

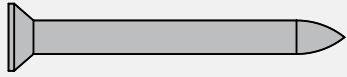

#10 X 1-3/4" Flat Head Screw
PG-HW-S018
QTY. 4

10. Attach boards **PG-544-054-ENC** & **PG-544-054-WT** with **PG-HW-S018** screws as shown in the **Inside View** & **Outside View**.

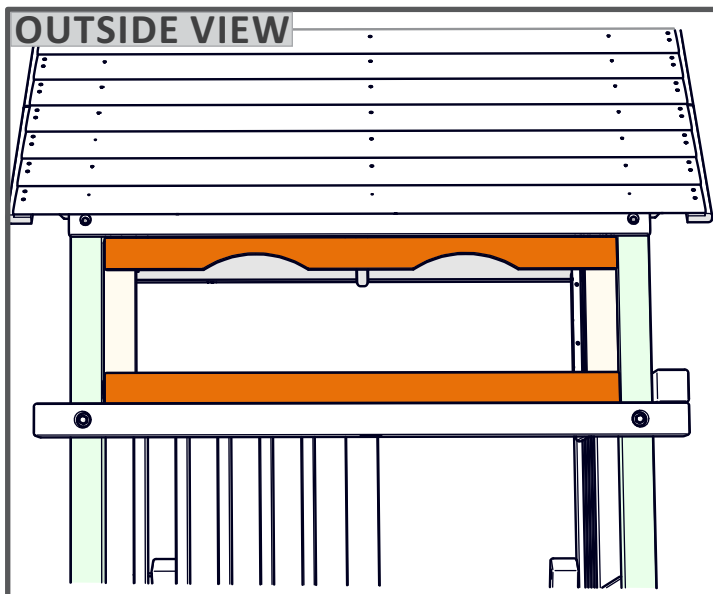
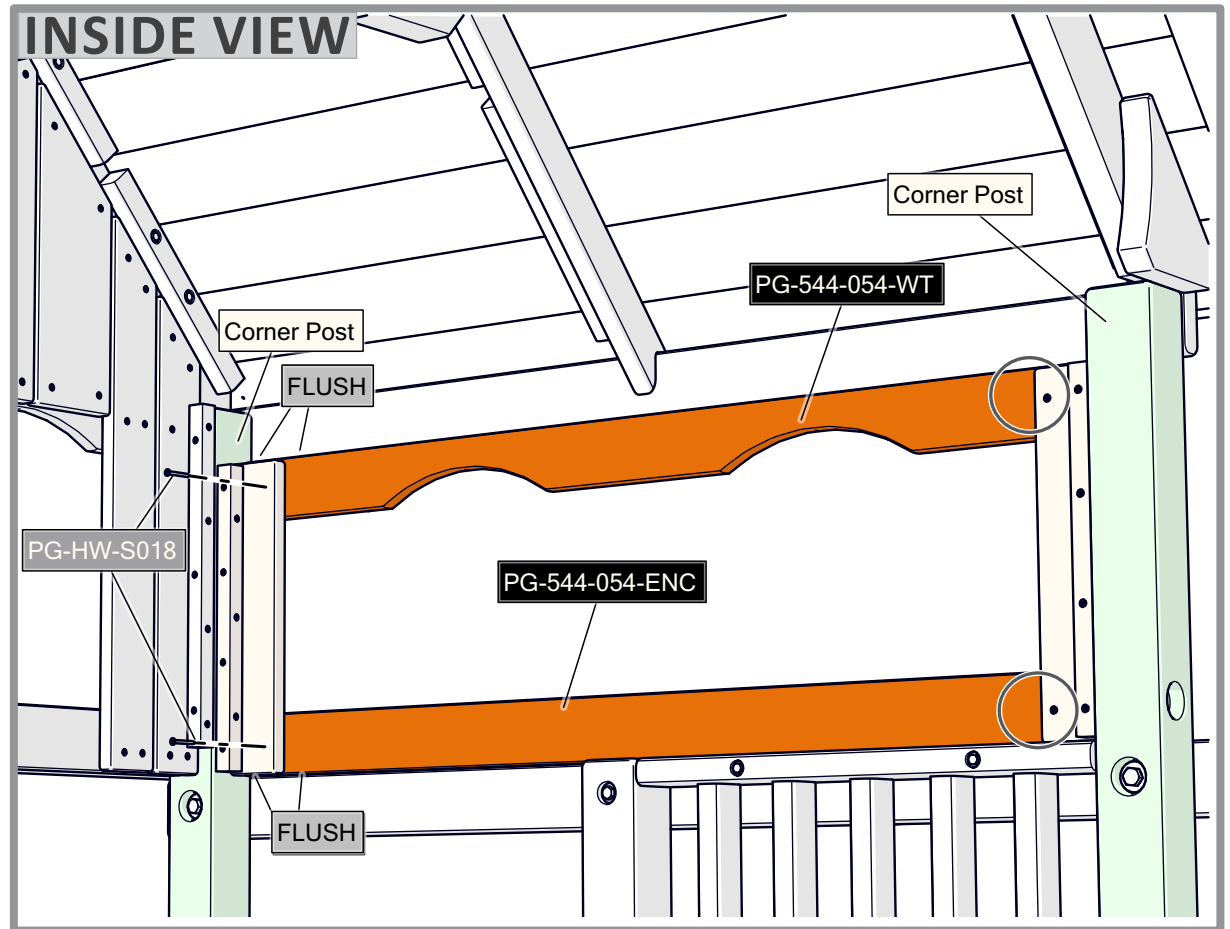

HARDWARE NEEDED (ACTUAL SIZE)

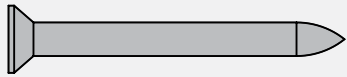

#10 X 1-3/4" Flat Head Screw
PG-HW-S018
QTY. 24

11. Space boards evenly and attach boards **PG-544-017-ENC** & **PG-546-017-ENC** with four **PG-HW-S018** screws each. See **Inside View** & **Outside View**.

12. Repeat Steps 8-11 on other Side to finish enclosing the playset.

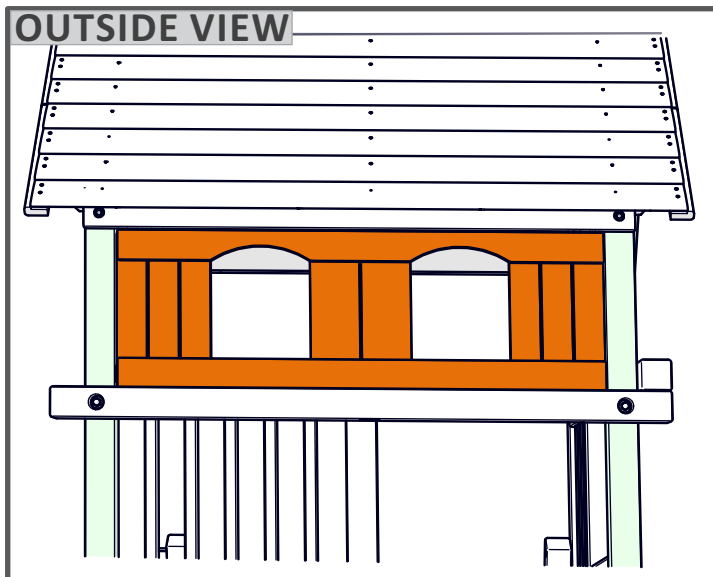
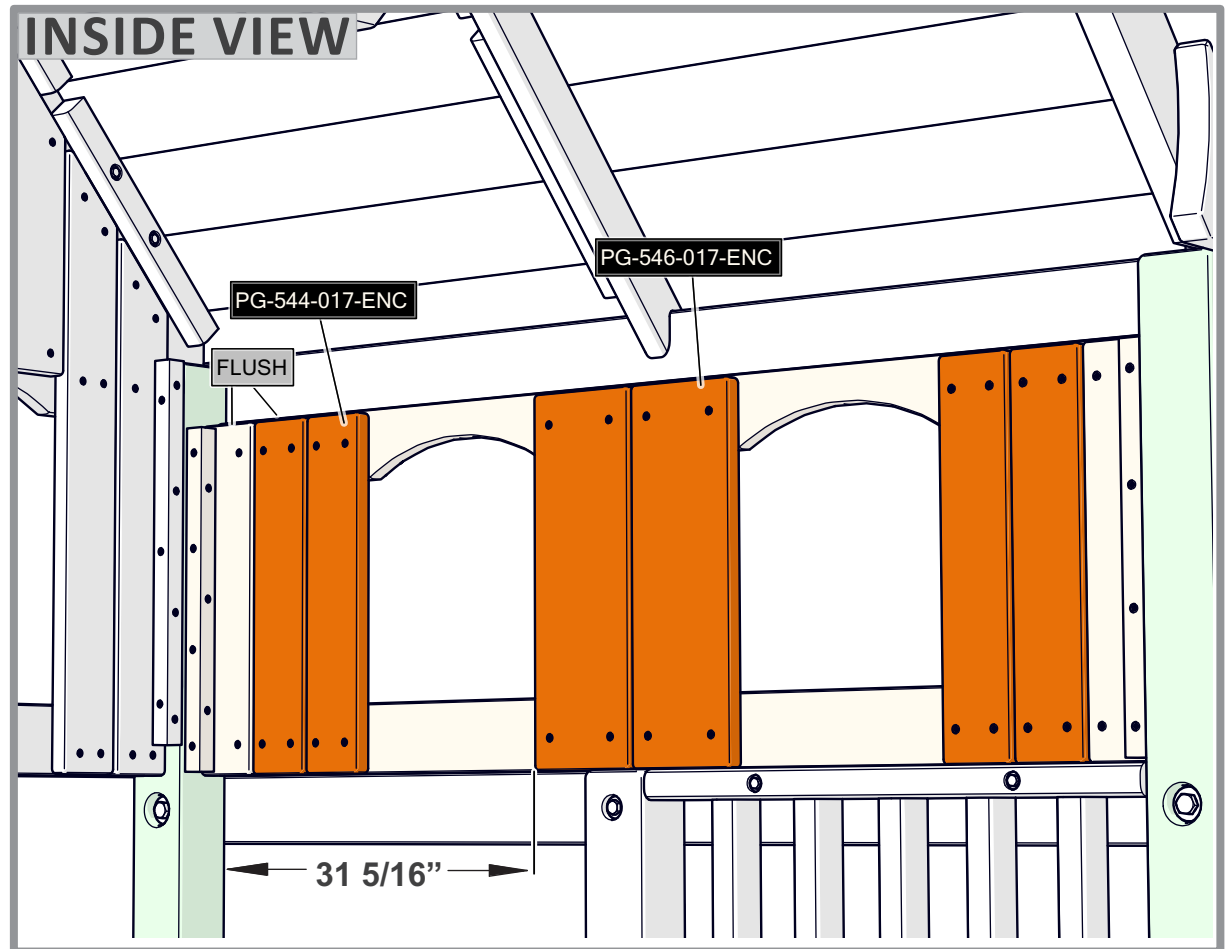

Consumer Information Sheet for Playground Surfacing Materials¹

The U.S. Consumer Product Safety Commission (CPSC) estimates that about 100,000 playground equipment-related injuries resulting from falls to the ground surface are treated annually in the U.S. hospital emergency rooms. Injuries involving this hazard pattern tend to be among the most serious of all playground injuries, and have the potential to be fatal, particularly when the injury is to the head.

The surface under and around playground equipment can be a major factor in determining the injury-causing potential of a fall. It is self evident that a fall onto a shock absorbing surface is less likely to cause a serious injury than a fall onto a hard surface. Playground equipment should never be placed on hard surfaces such as concrete or asphalt and while grass may appear to be acceptable it may quickly turn to hard packed earth in areas of high traffic. Shredded bark mulch, wood chips, fine sand or fine gravel are considered to be acceptable shock absorbing surfaces when installed and maintained at a sufficient depth under and around playground equipment.

The following table lists the maximum height from which a child would not be expected to sustain a life-threatening head injury in a fall onto four different loose-fill surfacing materials if they are installed and

maintained at depths of 6", 9", and 12". However, it should be recognized that all injuries due to falls cannot be prevented no matter what surfacing material is used.

It is recommended that a shock absorbing material should extend a minimum of 6' in all directions from the perimeter of stationary equipment such as climbers and slides. However, because children may deliberately jump from a moving swing, the shock absorbing material should extend in the front and rear of a swing a minimum distance of 2 times the height of the pivot point measured from a point directly beneath the pivot point supporting structure.

This information is intended to assist in comparing the relative shock-absorbing properties of various materials. No particular material is recommended over another. However, each material is only effective when properly maintained. Materials should be checked periodically and replenished to maintain correct depth as determined necessary for your equipment. The choice of a material depends on the type and height of the playground equipment, the availability of the material in your area, and its cost.

FALL HEIGHT IN FEET FROM WHICH A LIFE THREATENING HEAD INJURY WOULD NOT BE EXPECTED

TYPE OF MATERIAL	6" DEPTH	9" DEPTH	12" DEPTH
Double Shredded Bark Mulch	6'	10'	11'
Wood Chips	6'	7'	12'
Fine Sand	5'	5'	9'
Fine Gravel	6'	7'	10'

¹This information has been extracted from the CPSC publications "Playground Surfacing—Technical Information Guide" and "Handbook for Public Playground Safety." Copies of these reports can be obtained by sending a postcard to the Office of Public Affairs, U.S. Consumer Product Safety Commission, Washington, D.C. 20207. Or call the toll-free hotline: 1-800-638-2772.

WOODPLAY®

2016 WARRANTY

5 Year Warranty

Subject to proper installation and normal residential use, Woodplay warrants, subject to the limitations stated below, to the original retail purchaser, all chain, seats, swing hangers, hardware, metal braces, ropes and accessories to be free from defects in material and workmanship for a period of **five years** from date of purchase. Cracks in non-functional plastic components are not considered defects in materials and workmanship if they do not affect the functionality of the playset. Merchandise covered under this limited **five-year** warranty will, at our option, be repaired or replaced, excluding any freight or labor fees.

15 Year warranty

In addition, for **Fifteen years** after the original purchase date of our **Cedar** playsets, Woodplay warrants, to the original retail purchaser, all wooden components against structural failure due to corrosion, wood rot, or insect infestation. Seasonal checks, surface cracks, knotholes and knots, natural characteristics of all wooden play equipment, not resulting in structural failure, are not covered under this warranty. And will not affect the integrity of your playset.

Limited Lifetime Warranty

In addition, for the **lifetime** of our **Redwood** playsets, Woodplay warrants, to the original retail purchaser, all wooden components against structural failure due to corrosion, wood rot, or insect infestation. Seasonal checks, surface cracks, knotholes and knots, natural characteristics of all wooden play equipment, not resulting in structural failure, are not covered under this warranty. And will not affect the integrity of your playset. Woodplay warrants to the original retail customer that we will replace any swing hangers, swing chains, metal braces, metal rungs or hardware that fail due to rust or breakage (excludes surface rust). This limited lifetime warranty also applies to our exclusive Super Slide, Hurricane Slide and Alpine Slide.

Timber is a natural material which can absorb and release moisture. Although this product is designed to minimize this effect, in certain circumstances some movement or distortion is unavoidable. During dry hot weather timber may shrink and check - this is a normal process of weathering. After the first year of service it is advisable to clean and apply a non-toxic stain or sealant to the wood, safe for children's use.

Components covered under this **5 year, 15 year** and limited **lifetime warranty** will be replaced free of charge excluding freight and labor fees.

Non-residential use of the playset is prohibited and voids the warranty as the playsets are designed for residential use only.

Escalade Sports reserves the right to examine photographs and/or physical evidence of merchandise claimed to be defective, and to recover said merchandise, prior to disposition of warranty claims. Merchandise returned to our factory for examination or recovery must be shipped freight prepaid, unless a Return Authorization Number is issued.

This warranty program does not cover normal wear and tear, color fading, or damages resulting from misuse, abuse, vandalism, alteration, acts of God, or assembly and maintenance contrary to our instructions. Escalade Sports assumes no responsibility for incidental or consequential damages which may arise from the purchase or use of our equipment. Please supervise your children's play activity and maintain your play equipment periodically.

This warranty is expressly in lieu of all other warranties, expressed or implied, including warranties of merchantability or fitness for use. Woodplay does not assume or authorize any person to assume for us, any other liability in connection with the sale of our products.

Special Note: Woodplay reserves the right to make changes in materials, design, and pricing without notice. See your instruction manual for maintenance requirements. Your child's safety is your responsibility; therefore, you should inspect this equipment regularly for wear and safety.

For warranty service, contact:

**Woodplay Playsets
Escalade Sports
P.O. Box 889
Evansville, IN 47706
1-800-GO-SWING**

Or E-Mail us at: playgroundcs@escaladesports.com

Revised 2015