

BOSS[®]
AUDIO SYSTEMS

BVCPA10W

USER MANUAL

WIRELESS Apple CarPlay & Android Auto™
BLUETOOTH® | 340 WATTS | SINGLE-DIN
MP3-COMPATIBLE DIGITAL MEDIA AM/FM RECEIVER
FEATURING 10.1" (257 mm) CAPACITIVE TOUCHSCREEN
AND MULTICOLOR ILLUMINATION OPTIONS





Thank you for Choosing BOSS Audio Systems!

IMPORTANT! Fill Out And Keep For Your Records.



IMPORTANT

Record the serial number of the product:

Model:

Serial Number:

Date of Purchase:

The serial number is located on the top part of the chassis.

Contents

Contents	2	CarPlay Display.....	18	Media	23
Notes.....	4	Disable Apps.....	18	Warnings.....	23
Cautions.....	5-7	Android Auto™	19	USB Playback.....	23
About this Manual.....	7	Warnings.....	19	Navigating Menu.....	23
California Prop. 65.....	7	Using Android Auto.....	19	Photos.....	23
Basic Product Operation	8	Bluetooth®	20	Radio	24
What Comes in the Box.....	8	Cautions.....	20	Radio Home Screen.....	24
Product Basics.....	9-16	Setup & Connections.....	20	Tune to a Radio Station.....	24
Unit Installation.....	11	Phonebook.....	20	Store Radio Stations Automatically.....	24
Operation Instruction	12	Device Status.....	20	Select a Stored Radio Station.....	24
Display Screen Disassembly Instruction.....	13	Calling.....	21	Set a Favorite Station.....	24
Using and Caring for the Touchscreen.....	14	History.....	21	Stereo and Mono FM.....	24
Product Setup.....	15	Private Mode.....	21	Local and Distant FM.....	24
Navigating the Menus	16	Voice Assistant (Push-To-Talk).....	21		
Apple CarPlay	17	Audio.....	22		
Warnings.....	17	Track Control.....	22		
Using CarPlay.....	17	Media Player Source Switching.....	22		
Gestures & Control.....	17				

Contents

AV IN	25	Display Settings	28	Connections	30
Playback.....	25	Illumination Control.....	28	Cautions & Warnings.....	30-35
Camera	25	Gamma.....	28	Power/SWC	30
Warnings.....	25	LED Touch Buttons.....	28	Speaker.....	31
Reverse View.....	25	LED Animation.....	28	Audio Pre-amp/AV IN/Radio/GPS	32
General Settings.....	26	Bluetooth® Settings	29	Camera/USB/MIC.....	33
Cautions.....	26	Device Name.....	29	Parking Brake.....	34
System Language.....	26	Camera.....	29	Hands-free Mic.....	35
Time Zone.....	26	Rear Camera Input.....	29	SWC Compatibility	36
Date & Time.....	26	Front Camera Input.....	29	Troubleshooting.....	37
Auto Adjust Daylight Saving.....	26	Parking Assist Guide.....	29	Specifications.....	39
System Tone.....	26	Parking Assist Guide Adjust.....	29		
Power Off Delay.....	26	Rear View Delay.....	29		
Audio	27	Radio Settings	29		
EQ.....	27	Region.....	29		
Balance/Fader.....	27				
Subwoofer.....	27				
Loudness.....	27				
Internal Amp.....	27				
Volume.....	27				
Source Level.....	27				

Important

This symbol with “WARNING” is intended to alert the user to the presence of critical instructions/procedures. Failure to observe the instructions/procedures can result in injury, death, damage to the product and/or property.



This symbol with “CAUTION” is intended to alert the user to the presence of important instructions/procedures. Failure to observe the instructions/procedures can result in injury or damage to the product and/or property.



Use of the Apple CarPlay logo means that this user interface meets Apple performance standards. Apple is not responsible for the operation of this device or its compliance with safety and regulatory standards. Please note that the use of this product with iPhone may affect wireless performance.

iPhone® is a trademark of Apple Inc., registered in the U.S. and other countries.

Apple CarPlay is a trademark of Apple Inc.

Android Auto is a trademark of Google LLC.

The *Bluetooth*® word mark and logos are registered trademarks owned by Bluetooth SIG, Inc. and any use of such marks by BOSS Audio Systems is under license. Other trademarks and trade names are those of their respective owners.

Caution

Precautions

BE SURE TO OBSERVE THE FOLLOWING GUIDELINES: Do not turn up the volume so high that you can't hear what's around you.

Use caution or temporarily discontinue use in potentially hazardous situations.

Do not operate mobile video equipment while driving a motorized vehicle – safe driving and safety consideration of others should always be your highest priority.

Set your volume control at a low setting, then slowly increase the sound until you can hear it comfortably without distortion, or ear discomfort.

In the event you should notice smoke, strange noises or odor from this product, or any other abnormal signs, immediately turn off the power and consult your dealer or the nearest authorized **BOSS AUDIO SYSTEMS** Service Center.

Using this product in this condition may result in permanent damage to the system.

Installation Precautions

BOSS AUDIO SYSTEMS does not recommend to install the product yourself.

We recommend to have it professionally installed by a certified professional.

Always consult with a professional installer .

Do not attempt to install or service this product by yourself. Installation or servicing of this product by persons without professional training and experience in electronic equipment and motorized vehicle accessories may be dangerous and could expose you to the risk of electric shock, injury or other hazards.

Refer any repairs to a qualified BOSS AUDIO SYSTEMS Service Center.

Caution

Before Installing

To avoid potential shorts in the electrical system, be sure to disconnect the (-) battery cable before installation.

Use this unit with a 12-volt battery and negative grounding only. Failure to do so may result in a fire or malfunction.

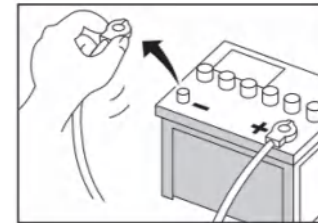
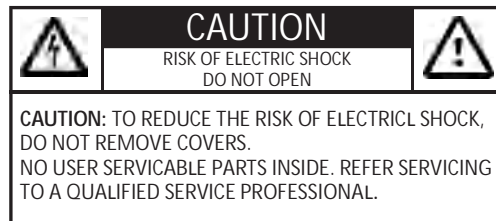

Product Safety

It is against Federal and Local laws for video to be viewed by the driver while the vehicle is in motion. This video product was intended to be used with the parking brake safety feature. Video cannot be seen without the proper parking brake powered connection. Tampering or disabling this feature will void any and all warranty. Please check with a professional installer to have your product installed properly.



Important Note

Due to ongoing enhancements, example images on screens may slightly differ from actual product.

Caution

Images and Video

Watching video while driving is against Federal, State, and Local laws.

Drive safely, know and obey traffic rules. Watching this screen and making selections while driving can lead to a serious accident.

Check surroundings for safety while camera images are displayed.

Do not use features of this product while driving if it cannot be operated safely and legally in your location. Before operation of smartphone Apps accessible from this device, read safety instructions in your Owner's Manual. When using navigation Apps stay alert to observe real world conditions.

About this manual

To entirely understand how to properly use your new BOSS Audio Systems product, it is recommended to read this user manual, and keep it in a safe place for future reference.

- Read the entire manual
- Keep the manual
- Follow all instructions
- Clean with a dry cloth only
- Do not use or operate near water
- Do not defeat any safety features

California Residents (Proposition 65)

This product may contain chemicals known to the State of California to cause cancer, birth defects or other reproductive harm.

Basic Product Operation

What comes in the box

Hardware

- Qty 1 BVCPA10W
- Qty 1 Rubber Grommet
- Qty 1 Hex Bolt
- Qty 1 Hex Nut
- Qty 8 Screw M5x6

- Qty 1 Tapping Screw 5X18 B/A
- Qty 1 Spring Washer
- Qty 2 Plain Washer
- Qty 2 Extraction Key
- Qty 1 Mounting Strap

- Qty 2 Mounting Brackets

Connections

- Qty 1 Wire Harness
- Qty 1 Hands-free Microphone
- Qty 1 GPS Antenna

* GPS Antenna: for navigation used by wireless Apple CarPlay and Android Auto

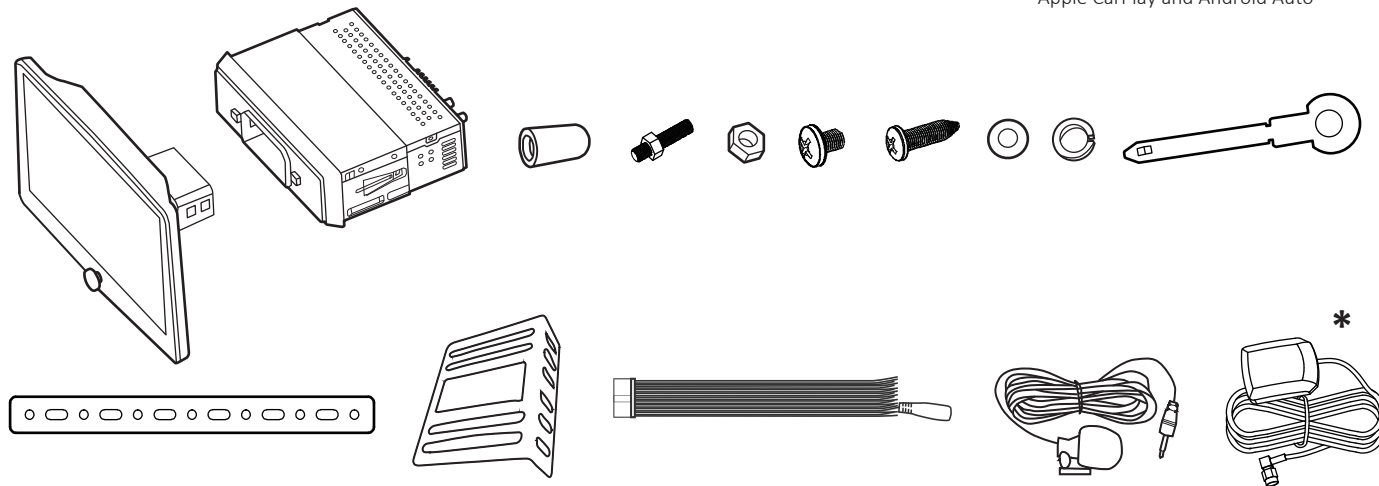

Basic Product Operation

Front Detail

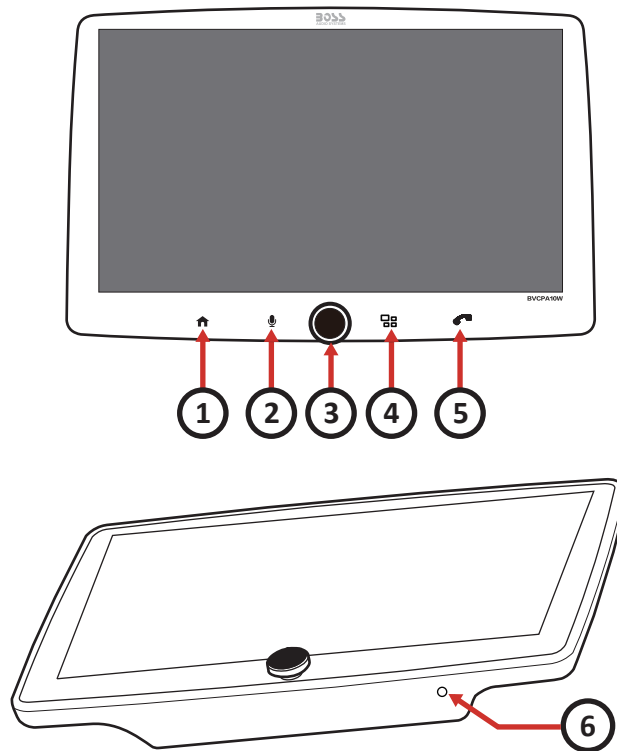

1. Menu Button

Touch to switch between the home menu and the last selected source.

2. Voice Control

Touch to activate voice assistant.

Enable Apple CarPlay, Android Auto, or Bluetooth connection to use voice assistant.

3. Power/Volume Knob

- Press to turn the unit on; press and hold to turn the unit off.
- Press briefly to mute or restore volume.
- Rotate to increase or decrease volume.

4. Mode Button

Touch to select a system mode.

5. Phone Button

Answer a phone call, or dial a Bluetooth phone call

6. Reset Pinhole

Press with a pin to restore the factory settings. Reset the unit when it has no response.

Basic Product Operation

Rear Detail

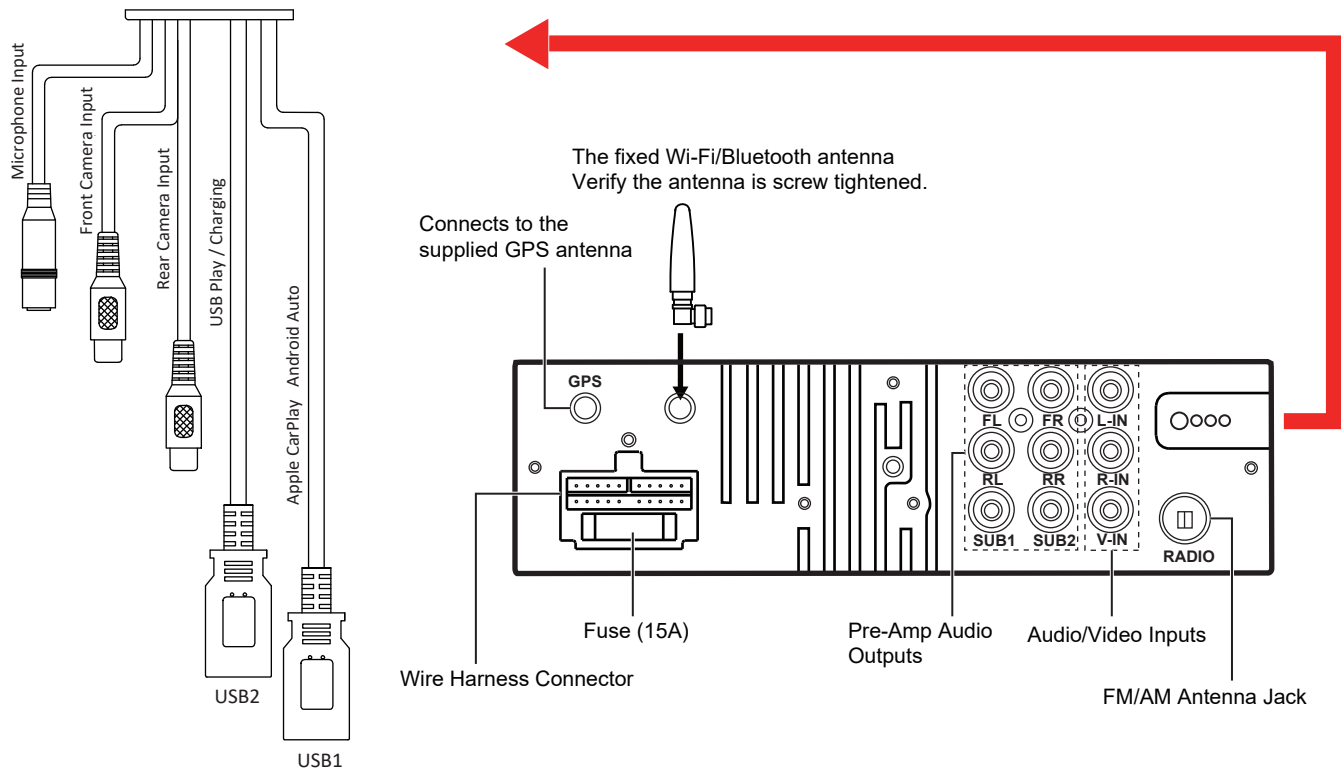

Basic Product Operation

Unit Installation

THE UNIT IS INSTALLED TO BE AN ANTI-THEFT ONE. THE CHASSIS OF THE UNIT WEARS A SLIDING METAL HOUSING. PLEASE DO THE CONNECTION OF THE POWER, SPEAKERS AND ANTENNA ACCORDING TO THE REQUIREMENT OF THE INSTRUCTION BOOK , THEN INSTALL THE SLIDING METAL HOUSING IN THE CAR AS FOLLOWS.

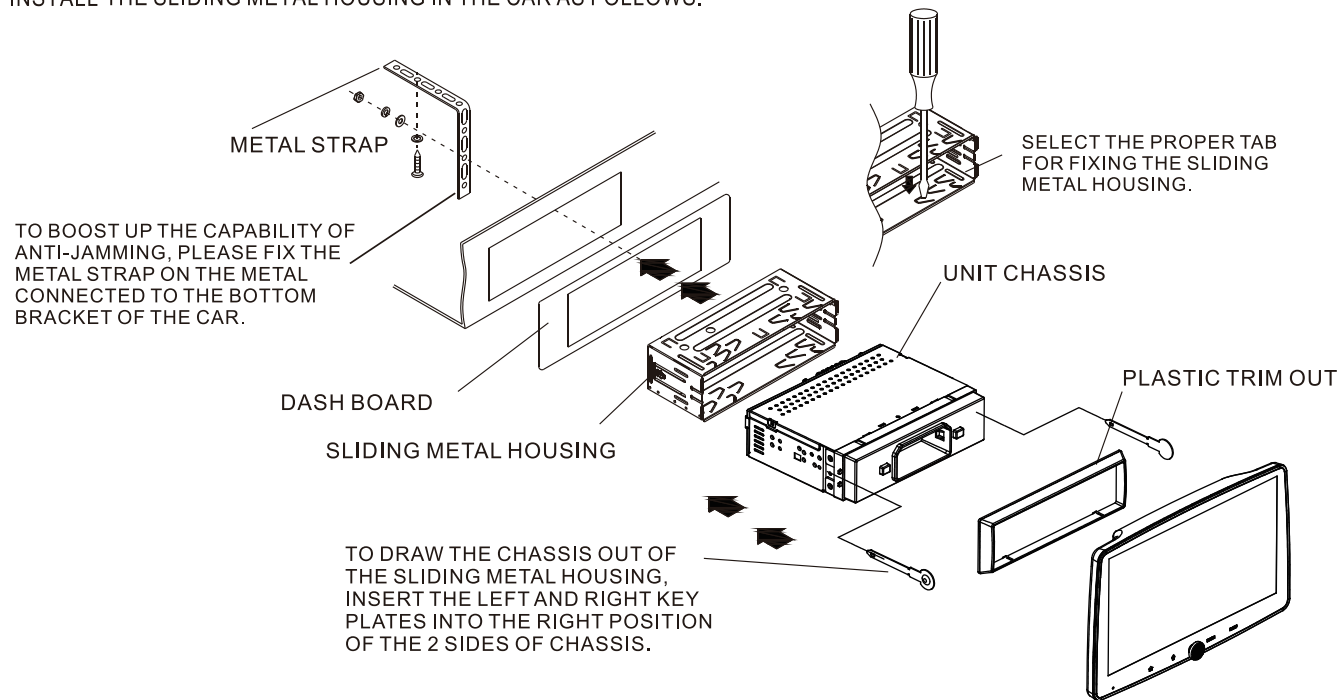

Basic Product Operation

Operation instruction

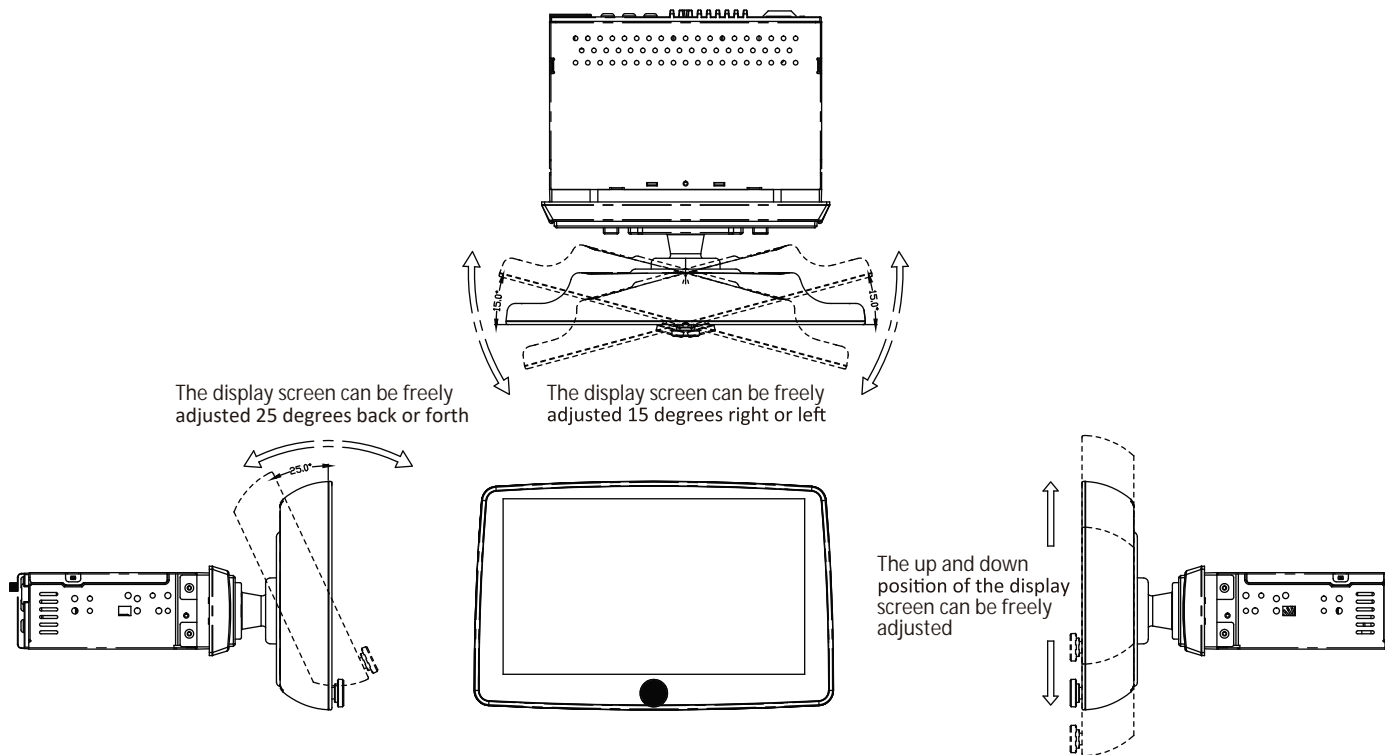

Basic Product Operation — CAUTION!

Display screen removal

1. Hold down the two release buttons

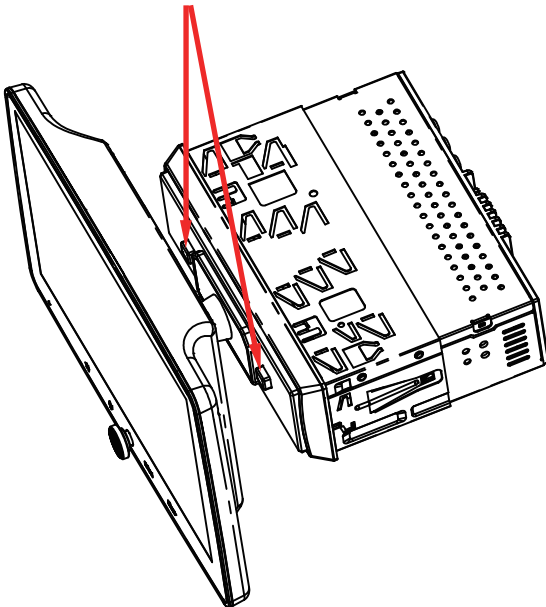

2. Gently pulling the display panel forward

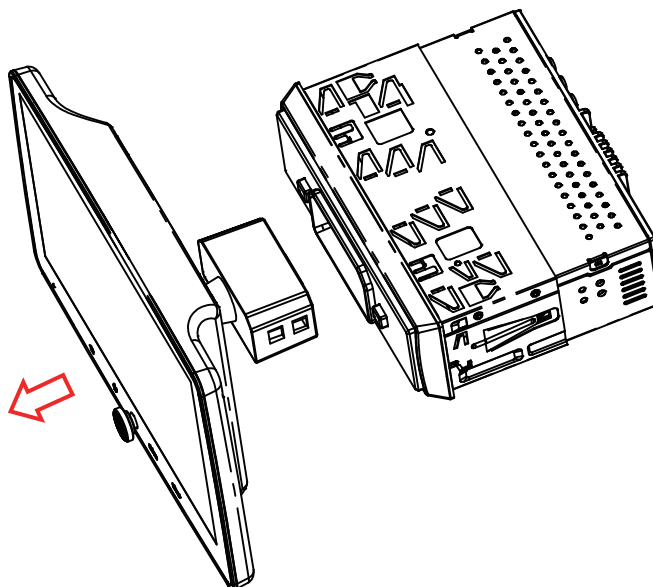

Basic Product Operation

Using and Caring for the Touchscreen

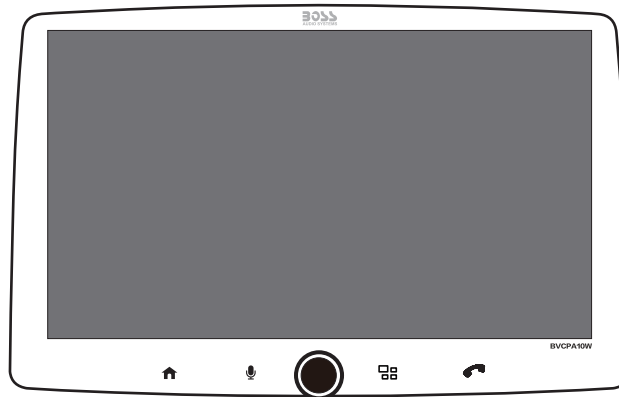

Use:

This head unit utilizes a Capacitive Touchscreen, the same type that is used on high-end mobile devices. It should be used for and cared for like that type of device. As with all capacitive type technology, if your fingers are wet or sweaty, it will not function properly.

Do not allow any sharp objects to come in contact with the screen glass.

Care and Cleaning:

To clean the screen, use a dry microfiber type cloth to clean. Do not use ammonia, window cleaner, or any other type of household chemicals to clean the screen. Abrasives should not be used at all.

Basic Product Operation

Product Setup (Date & Time)

Setup Option A: CarPlay Method

Connect your Apple® device using a Lightning® cable. The CarPlay USB port must be used.

This will automatically setup the time and date.

User must set Time Zone manually.

Default is Pacific Time Zone.

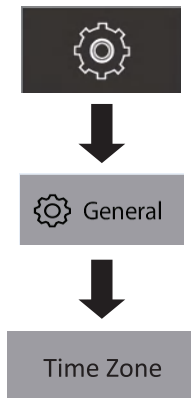

Setup Option B: Date and Time

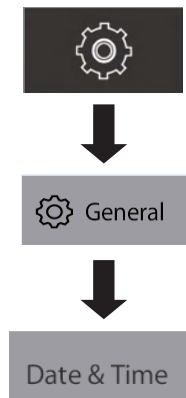

Additional Setup

General > Language

Audio > EQ, Other Audio Settings

Display > Illumination, Brightness

Basic Product Operation

Navigating the Menus

Android Auto

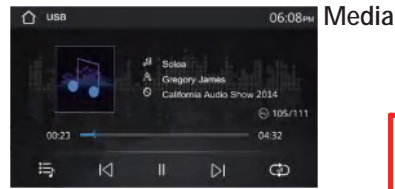
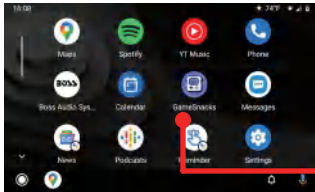

Camera



CarPlay

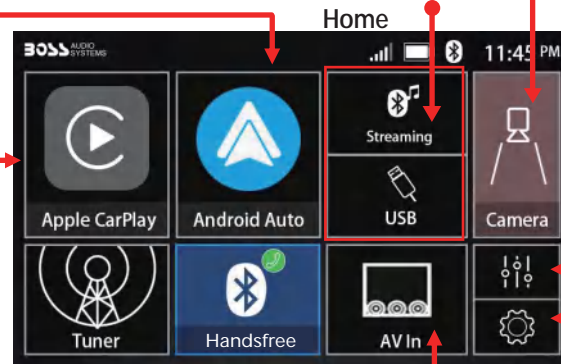
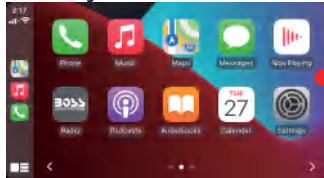

EQ

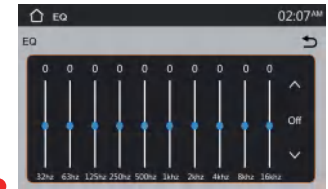

Tuner



Hands-free

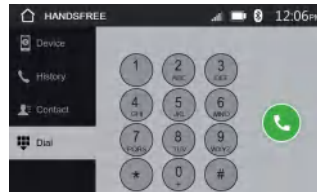

AV IN

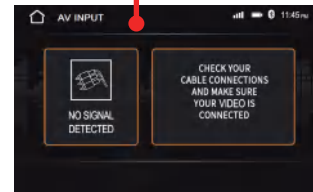

Settings

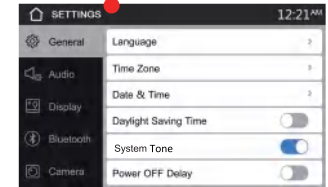

Apple CarPlay

Using CarPlay

Note

Apple CarPlay usage is limited while driving. Functions, content, and usability is determined by the App provider(s). Controls will vary with each App that is available for CarPlay. For more details visit:

<http://www.apple.com/ios/carplay>

WARNING

Familiarize yourself with your Local and State laws regarding mobile devices.

Certain functions of an iPhone might be prohibited and or illegal while driving in your location.

When in doubt, park the vehicle and engage the parking brake first before performing the function(s).

Wired Connection via USB Port

Connect your iPhone to the USB port (labeled "Apple CarPlay") with a lightning cable (not included) to enable CarPlay connection.

For the initial USB connection, you will be prompted to enable wireless CarPlay on your iPhone.

Wireless Connection

Enable Wi-Fi and Bluetooth on your iPhone.

For first-time use of wireless CarPlay between your iPhone and this unit, you need to allow wireless CarPlay use via either of the pairing:

- Bluetooth pairing. On your iPhone, go to **Settings > Bluetooth** then select "BOSS AUDIO BVCPA10W" for pairing. Enable wireless CarPlay when prompted on your iPhone.
- Initial USB port connection for CarPlay.

To enable CarPlay connection

Bluetooth connection will disable wireless CarPlay connection.

On the home screen, go to **Handsfree > Device** then touch the paired iPhone name to enable wireless CarPlay connection.

To enter CarPlay menu

Touch the "Apple CarPlay" icon on the home screen.

Note

If you do not allow wireless CarPlay use during first-time CarPlay connection, wireless CarPlay will be disabled on your iPhone. To use wireless CarPlay later, you need to enable CarPlay on your iPhone (go to **Settings > General > CarPlay > paired device** then enable its CarPlay).

When connecting to CarPlay, Bluetooth on this unit will be automatically disabled. In this case, you can make hands-free calls and stream music through CarPlay.

Gestures & Control

Basic controls, but not limited to:

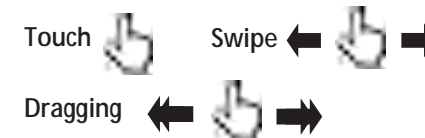

Other gestures and controls might differ from apps.

Note

Volume control is handled exclusively by this unit.

Apple CarPlay

Using CarPlay

CarPlay Display Setup

You can add, remove, or arrange the order of the apps on the CarPlay screen of the unit.

1. On your iPhone, go to **Settings > General > CarPlay**, select this unit's name from the device list (shown below). Then select **Customize** to access CarPlay apps.

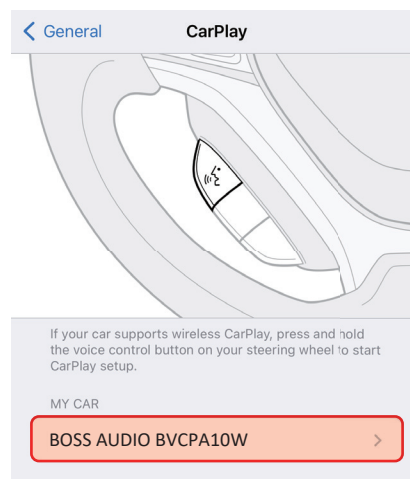

If your car supports wireless CarPlay, press and hold the voice control button on your steering wheel to start CarPlay setup.

MY CAR

BOSS AUDIO BVCPA10W

2. Touch and drag an app (≡) to change the order of an app.

Touch **-** or **+** to remove and add apps.

Note

Only apps with **-** or **+** can be removed from CarPlay or added in CarPlay.

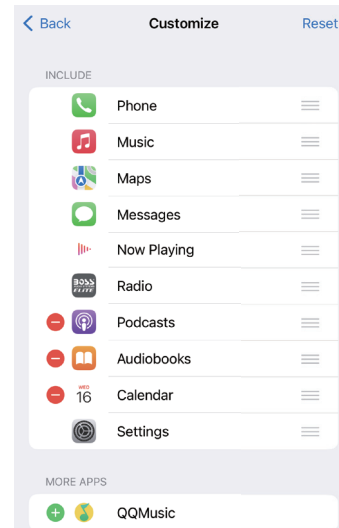

Disable Apps

You can disable all CarPlay apps to restrict CarPlay use on this unit.

On your iPhone, go to **Settings > Screen Time > Contents & Privacy Restrictions > Allowed Apps > CarPlay**.

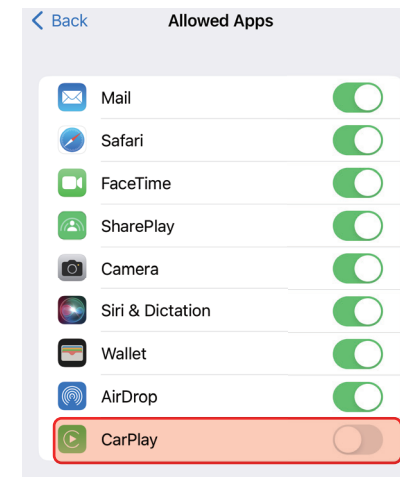

Android Auto

Using Android Auto

Note

Android Auto usage is limited while driving.

Functions, content, and usability is determined by the App provider(s).

Controls will vary with each App that is available for Android Auto.

For more details visit:

<https://www.android.com/auto/>

WARNING

Familiarize yourself with your Local and State laws regarding mobile devices.

Certain functions of the mobile device might be prohibited and or illegal while driving in your location.

When in doubt, park the vehicle and engage the parking brake first before performing the function(s).

NOTE

To complete the setup properly, the parking brake status wire must be connected.

WARNING

For your safety, the setup process **MUST** be accomplished while the vehicle is **Parked and Parking Brake Engaged**.

Android Auto App

For Android 9.0 or earlier, download and install the Android Auto app from Google Play. For smartphone with Android 10.0 or later, plug in your phone and follow the prompts on your phone to accept the permissions that Android Auto requires.

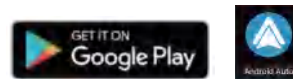

Minimum System Requirements

- Wired connection: Android 6.0
- Wireless connection: Android 11.0

For a list of compatible devices:

<https://www.android.com/auto/>

Updating Related Apps

During the first start up and setup of the Android Auto app, the Maps, Music, Google apps will install/update automatically.

Wired Connection via USB Port

Connect your phone to the USB port (labeled "Android Auto") with a USB cable (not included) to enable Android Auto connection.

For the initial USB connection, you will be prompted to connect wireless Android Auto on this unit.

Wireless Connection

Enable Wi-Fi and Bluetooth on your Phone.

For first-time use of wireless Android Auto between your phone and this unit, you need to allow Android Auto use via either of the pairing:

- Bluetooth pairing. On your phone, go to **Settings > Bluetooth** then select "BOSS AUDIO BVCPA10W" for pairing.
- Initial USB port connection for Android Auto.

To enable Android Auto connection

Bluetooth connection will disable wireless Android Auto connection.

On the home screen, go to **Handsfree > Device** then touch the paired phone name to enable wireless Android Auto connection.

To enter Android Auto menu

Touch the "Android Auto" icon on the home screen.

When connecting to Android Auto, Bluetooth on this unit will be automatically disabled.

Bluetooth®

Setup & Connection

Hands-Free Menu

Touch

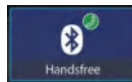

NOTE

Enabling CarPlay or Android Auto will disabling Bluetooth connection.

Compatibility with all mobile devices is not guaranteed. Please read through the user guide of the mobile device.

CAUTION

For your safety, the setup process should be accomplished while the vehicle is parked and parking brake engaged.

First time Pairing

Pair this product with your Bluetooth device before you can make hands-free calls or stream music through Bluetooth.

Bluetooth pairing can be made through initial connection to CarPlay or Android Auto. Or follow the instructions below to complete it.

On your mobile device, go to **Settings > Bluetooth** then select **"BOSS AUDIO BVCPA10W"** for pairing.

Follow the prompts on your mobile device and this product to complete Bluetooth pairing.

Enable Bluetooth Connection

When CarPlay or Android Auto is connected to this product, Bluetooth connection will be disabled. In this case, you need to enable Bluetooth connection.

On the home screen, go to **Handsfree > Device** then touch . Tap the icon again to disconnect Bluetooth connection.



For wired CarPlay or Android Auto connection, unplug the connection cable for use of Bluetooth connection.

When Bluetooth is enabled, CarPlay or Android Auto will be disabled. You can now make hands-free calls or stream music through Bluetooth (on the home screen, touch the **"Streaming"** icon to access Bluetooth streaming).

Phonebook and History

To **Download Phonebook**:

1. Touch **Contact > Download**

To **Download History**

1. Touch **History > Download**

Device Status

Battery and Cellular Strength is displayed on the top right of the Home menu.

GATT Profile support is required on the mobile device.



Bluetooth®

Hands-Free

Calling

Making & Receiving Calls

1. Dialing from the dial pad

Touch  to make call

2. Contacts

Touch the contact name

3. History

Choose the name, then

To End a call Touch 

To Mute a call Touch 

Dial pad

To use the dial pad while on a call



Touch 

Searching History

Swipe Up or Down to search





History

1. Outgoing Call 
2. Incoming Call 
3. Missed Call 

Private Mode

When a call needs to be transferred to the mobile device:

Touch  to switch the mobile device

Touch  to return to hands-free mode

Searching Contacts

Contacts must be downloaded to search.

1. Touch 
2. Enter the Contact Name, then

Voice Assistant (Push-To-Talk)

From the home screen, go to  (Settings) > **Bluetooth** to access the following options.

Connection: **ON**

Auto Connect: **ON**

Auto Answer: **OFF**

Device Name: **BOSS AUDIO BVCPA10W**

Clear Records

Voice Assistant (Push-To-Talk)

You can access smartphone voice assistant through the unit.

Before you start

- Enable Bluetooth connection between your smartphone and the unit, or enable Apple CarPlay/Android Auto.
- Make sure the supplied hands-free microphone is connected to the Microphone Input of the unit for audio input.

Simply press  on the front panel to activate voice assistant, then speak your command.

Bluetooth®

Audio

Audio Streaming

To play media through Bluetooth, the mobile device must be **Paired and Connected** to the BVCPA10W.

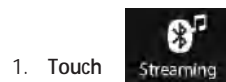

If CarPlay or Android Auto is connected, you need to enable Bluetooth on this product (on the home screen, go to **Handsfree > Device** then tap .

For wired CarPlay or Android Auto connection, unplug the connection cable for use of Bluetooth connection.



The music will play automatically.

Track Control

1. Play/Pause 
2. Track Fwd / Rev 
3. Swipe to Fwd/Rev 

Note

For best performance, your mobile device volume setting should be set to maximum.

All volume adjustments for the system should be controlled from the product.

The unit will recall the last volume setting on your mobile device every time Bluetooth connection is made.

Formats

Playback is supported from the mobile device with any format it can play.

Audio will only be played by the product.

Video cannot be viewed on the unit.

Switching Media



Available sources will display **(Bluetooth and USB)**

Note

USB source will only be displayed if a USB drive is inserted and has playable media.

Display

Track info will be displayed when available.

Track, Album and Artist.

Album art is not supported via Bluetooth playback.

Media

USB

USB Playback



The music will play automatically.

Audio Control

1. Play/Pause 
2. Track Fwd / Rev 
3. Repeat ALL 
4. Repeat One 
5. Random 

Note

If there are other files in the USB, music files will play first.

Video Control











1. Play/Pause 
2. Track Forward/Backward 
3. Repeat All 
4. Repeat one 
5. SETUP 

Photo Control

1. Play/Pause 
2. Track Forward/Backward 
3. Repeat All 
4. Repeat One 
5. Rotate 

Navigating Menu



To browse contents, **Swipe** 

To return to the current file playing,



WARNING

Watching videos or photos while driving is against Federal, State, and Local laws.

Do not use features of this product if it cannot be operated safely and legally in your location.

Note

Review the connections of this product, to properly integrate the parking brake wire to the vehicle.

Video and or photos cannot be viewed while driving. The vehicle must be stationary and the parking brake applied to enable viewing.

Radio

FM / AM

On the home screen, touch the Tuner icon to switch to radio.

Radio Home Screen

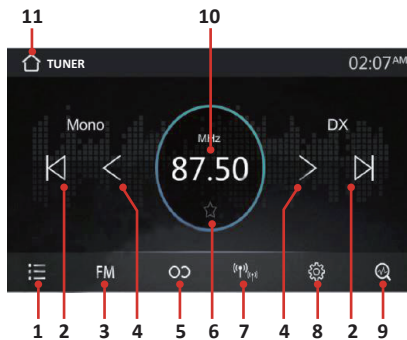

1. Access the list for stored FM, AM, or favorite stations.
2. Tune to a station, or select a stored station.
3. Switch between FM and AM.
4. Adjust radio frequency by step.
5. Switch between Stereo and Mono FM.
6. Set/remove the current station as favorite.
7. Switch FM reception between local (LOC) and distant (DX).

8. Access radio setting menu.
9. Search and store FM or AM stations.
10. Touch the station frequency to access the favorite stations list.
11. Return to the Home Menu screen.

Tune to a Radio Station

Touch and hold . The unit automatically tunes to a station with strong reception.

To fine tune a station

Touch to adjust frequencies step by step.

Store Radio Stations Automatically

Touch to perform radio search. All available stations in FM or AM band are stored on the unit.

Select a Stored Station

Touch briefly to select a stored station.

Or touch to access the station list for the stored FM and AM stations.

Set a Favorite Station

When listening to a station, touch to set the current station as favorite. The gray star icon will turn to the red star icon.

To remove a favorite, touch .

To access the set favorite stations, touch the radio frequency displayed. The favorite list appears.

Switch between Stereo and Mono FM

In FM, touch to select Stereo or Mono FM. Select Stereo to receive FM stereo broadcast.

When the signal is weak, select Mono to improve sound quality (stereo effect will be lost).

Switch between Local and Distant FM

In FM, touch to select local or distant reception.

“LOC” display indicates local reception, “DX” display for distant reception.

Select “DX” when most radio stations are weak (e.g. in the countryside). FM stations with strong and weak signals will be received.

Select “LOC” when most radio stations are strong enough (e.g. in urban areas). FM stations only with strong signals will be received.

AV In/Camera

External Source

Playback

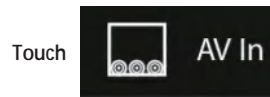

Media must be controlled from the external device.

Track functions are not controlled from the product.

Note

To adjust the volume level properly, the carry-in device volume should be set between 50% - 75%. The volume level should remain at that level for the remainder of the time it is connected to the product.

WARNING

Never rely solely on the rear view camera; always check your surroundings before proceeding.

Images may appear reversed

Do not use features of this product if it cannot be operated safely and legally in your location.

Rear View

The rear view camera can be displayed on demand.

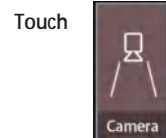

If the user opens the SETTINGS interface and turn on both FRONT CAMERA and REAR CAMERA functions, you can choose REAR CAMERA and FRONT CAMERA casually.



To return to the Home screen



Reverse View

When the vehicle is put into reverse gear, the camera will display the image on the screen.

CHECK SURROUNDINGS BEFORE PROCEEDING



Rear View Delay

Due to varying vehicle configurations, the rear view trigger can be delayed to best suit the vehicle.

Default setting: 0 Sec Delay

Note

The rear view camera will still function normally, if the product is in standby mode.

Settings

General

System Language

Touch to change
English (Default), Spanish

Note

CarPlay is independent of the system language setting.

Time Zone

Adjust to correctly display time
Default Setting: (GMT-08:00) Pacific Time (US&Canada)

Date & Time

24H Mode

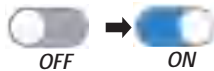

Auto Adjust Daylight Saving

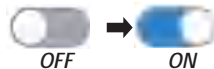

Note

If using an CarPlay, the iPhone will automatically set date & time. Time Zone needs to be adjusted manually.

System Tone



Power Off Delay

Some vehicles during crank to start will interrupt the accessory power.
If the product re-boots during crank to start, Turn **ON** delay
The delay can select 1, 2 or 3 sec.
Default Setting: **OFF**

Note

Power Off Delay **ON** will also delay when the vehicle is turned OFF.
This might affect hands-free functionality during a call.

Factory Settings

To restore settings to default:

Touch 

CAUTION

Will restore all settings to factory defaults.
All settings and presets will be lost.

Settings

Audio

EQ

To access the EQ menu

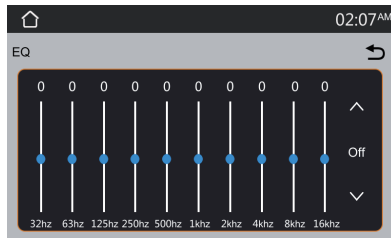

Note

The EQ can also be directly accessed while changing the volume. The volume display will show the EQ icon, you can touch to access the Audio Settings.



Preset EQ

Jazz, HipHop, Pop, Rock, R&B

Balance/Fader

Left/Right Balance, Touch



Swipe for quick adjustment 

Front/Rear Fader, Touch



Swipe for quick adjustment 

Subwoofer

The level and filter can be adjusted for the Sub pre-amp output.

Level, 1-14 dB

Swipe 

Filter: 50 Hz, 80 Hz, 120 Hz, 160 Hz

Touch +/- to select a cutoff frequency for your subwoofer.

Loudness

Enhances and gently boosts low and high freq.

Touch  OFF → ON

Internal Amp

To reduce the possibility of noise entering the signal chain when utilizing the audio pre-amp outputs, the internal amp can be turned OFF

Touch  ON → OFF

Default Volume

Adjust startup/initial volume for Main (Radio, Media), Hands-free (BT Ring, BT Talking), Apple CarPlay/Android Auto (Navi, Voice).

Startup/initial volume will be the set volume if the set volume is less than the last shutdown/used volume.

Startup/initial volume will be the last shutdown/used volume if the set volume is greater than the last shutdown/used volume.

Source Level

Adjust volume independently for each source (Radio, USB, BT Audio, AV Input, Apple CarPlay, Android Auto).

Settings

Display

Illumination Control



When the vehicle lights are on, the products illumination can be customized for night use.

Gamma



Gamma can be adjusted for both day and night settings.

Screen Brightness



LED Touch Buttons

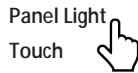

Six preset colors can be chosen for Touch buttons.

To select a preset color, make sure LED Animation feature is turned off.

LED Animation



Will cycle through all colors on LED touch buttons.

Default Setting: ON

UI settings

Wall paper

Touch to change

User can change the background picture by inserting a USB with photos.

Background Brightness



Connection



Power On/Off Bluetooth

Default Setting: ON

Bluetooth

Note

Bluetooth will turn OFF automatically when CarPlay or Android Auto is connected. If other devices are connected via Bluetooth, they will be disconnected for CarPlay/Android connection.

To enable Bluetooth connection, on the home screen, go to Handsfree > Device then tap . For wired CarPlay or Android Auto connection, unplug the connection cable for use of Bluetooth connection.

Auto Connect



Auto connects to the device when the product is powered ON

Default Setting: ON

Auto Answer



Auto answers when there is an incoming call.

Default Setting: OFF

Settings

Bluetooth

Device Name

BOSS AUDIO BVCPA10W

Rear Camera Input

Turn on if you have a rear view camera, turn off if you have not.

Front Camera Input

Turn on if you have a front view camera, turn off if you have not.

Parking Assist Guide

Turn off if your rear view camera have parking assist guide, turn on if you have not.

Camera

Parking Assist Guide Adjust

If your rear view camera does not have parking guide lines, turn on the parking guide lines built in this unit and adjust the guide lines if found necessary.

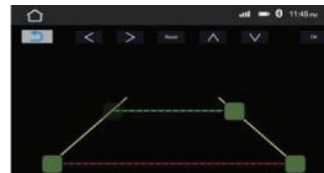

Touch and drag a square icon to reposition the related guide line. Repeatedly touch an arrow icon to fine tune positioning of the related guide line. Touch the OK icon to confirm the adjustment. To reset to the default positioning of the guide lines, touch the Reset icon.

Radio

Rear View Delay

0 Sec (Default), 0.1 Sec, 0.5 Sec, 1 Sec, 2 Sec
When switching from Park to Drive, or vice versa, the camera should not trigger on the display.
Sensitivity should be adjusted to trigger only on reverse gear selector.

Region

Touch 

Default Setting: USA 2

US Tuner Spacing: FM (200 KHz), AM (10 KHz)

European Spacing: FM (50 KHz), AM (9 KHz)

Connections

Power/SWC

CAUTION

It is recommended to have the product installed by a certified installation professional.

CAUTION

Before installation, or wiring connections, disconnect the negative (-) battery terminal to prevent damage to the product, and/or possible injury.

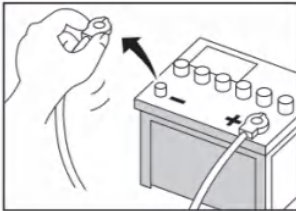

CAUTION

Remote Out is 500 mA max output rating. If several amplifiers are to be used, it is recommended to use a relay for the Remote Out trigger.

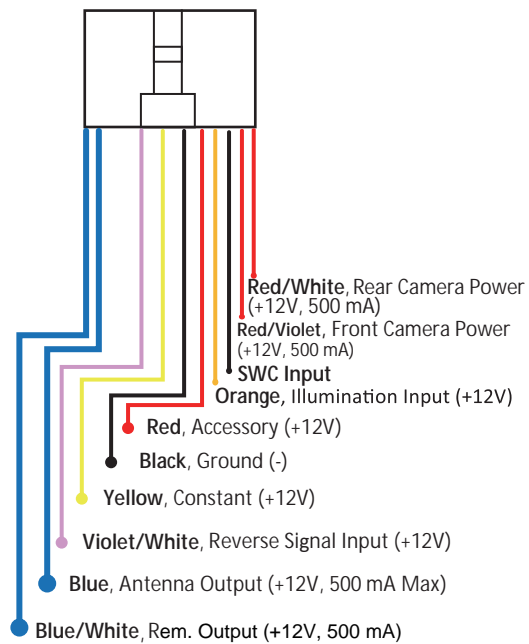

i Note

Unused input/output wires need be insulated with tape, heat shrink, or crimp connectors. **Never use wire nuts.**

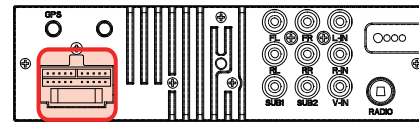

Location to plug in

i Note

A separate interface might be needed for your vehicle application. It is recommended that you consult with a professional installer.

i Note

When replacing the fuse, always do so with the same type and value (**15 A**).

Connections

Speakers

CAUTION

Do not chassis ground any speaker wire leads.

CAUTION

Only use 4-8 Ω Speakers
Do not use 1-3 Ω Speakers

CAUTION

Do not bridge any of the channels, they are only to be wired in stereo mode.

Note

Unused speaker wires need be insulated with tape, heat shrink, or crimp connectors.

Never use wire nuts.

If the speaker outputs are not used, turn **Off** the internal amp to reduce the possibility of noise entering the signal chain.

Note

Observe speaker polarity when making connections.

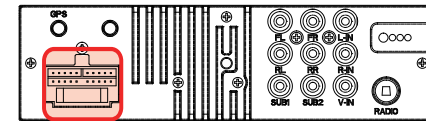
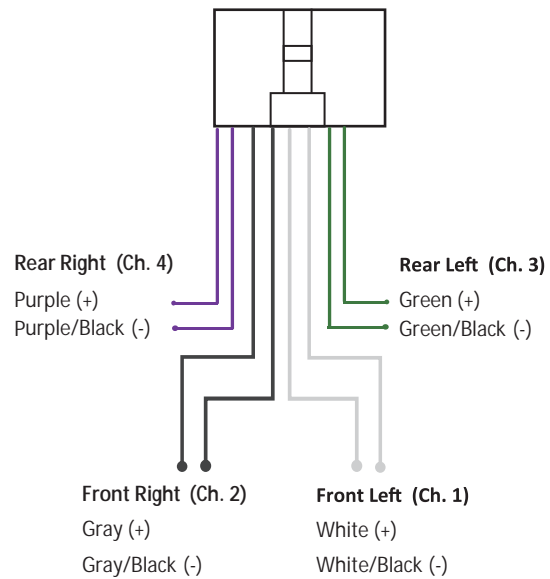

Location to plug in

Connections

Audio Pre-amp/AV IN/ Radio/GPS

i Note

Subwoofer Pre-amp is a non-fading mono output.

i Note

Always run signal wires away from power cables to reduce the possibility of noise.

i Note

This product has GPS positioning function which is only used as an auxiliary function of Android Auto / CarPlay navigation. If the following icon is displayed on the top of the screen, this indicates no or improper GPS antenna installation. Check whether the supplied GPS antenna is correctly and securely installed on the rear of the product.

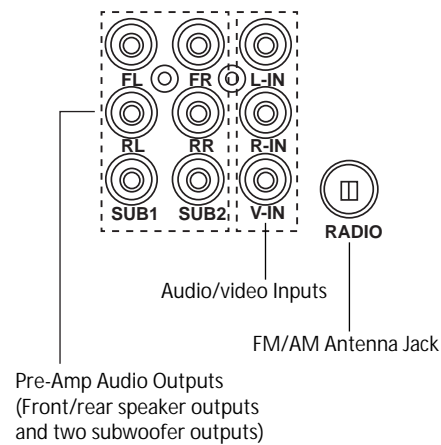
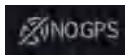

i Note

If pre-amp outputs are being used exclusively, turn **Off** the internal amp of the product, to reduce the possibility of noise entering the signal chain.

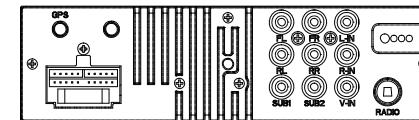

Location to plug in

Connections

Camera/USB/MIC

WARNING

Never rely solely on the rear view camera; always check your surroundings before proceeding.

Images may appear reversed

Do not use a feature of this product if it cannot be operated safely and legally in your location.

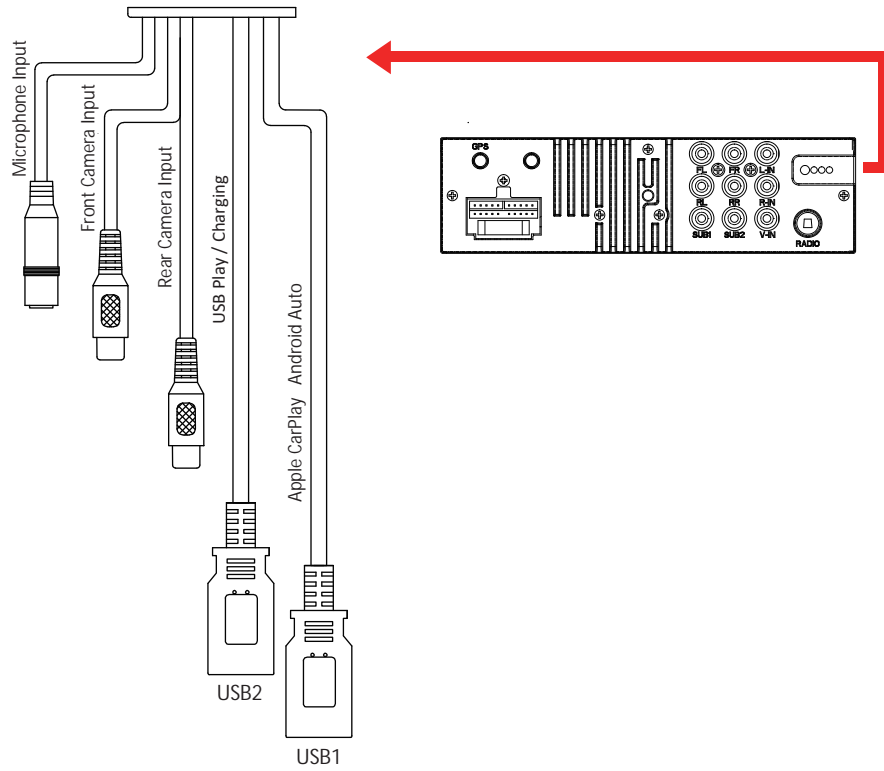

Connections

Parking Brake

WARNING

Improper connection or use of the parking brake status wire, (i.e. defeating the safety feature) violates Federal, State, and Local laws. This may lead to injury, property damage, and/or death.

WARNING

Watching videos or photos while driving is against Federal, State, and Local laws.

Note

For Android Auto setup, the parking brake status wire **MUST** be connected.

Note

Review the connections of this product, to properly integrate the parking brake wire to the vehicle.

Video and or photos cannot be viewed while driving. The vehicle must be stationary and the parking brake applied to enable viewing.

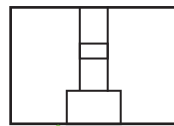

Lt. Green, Parking Brake Input

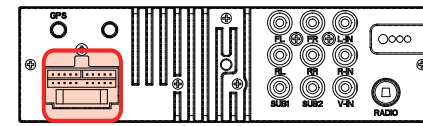

Power/Speaker/SWC/Harness

Note

The parking brake input needs to be connected to the parking brake wire.

Note

Every vehicle has a different type of parking brake connection; consult a certified professional installer.

Connections

Hands-free Mic

Placement

Every vehicle will perform differently due to layout, interior materials, etc.

The **Red** shaded areas are the recommended locations for best microphone performance.

Items to look for before placement:

1. Do not place in front of air vents.
2. If the vehicle has tweeters placed on sail panels, do **NOT** locate the mic on steering column area.
3. Front of mic must not be blocked.
4. Mic should be firmly attached to mounting location.
5. Do not cover the grille openings surrounding the mic.
6. To avoid excessive wind noise, do not place near the sunroof opening

WARNING

Run microphone wire where it will **NOT** impede the operation of any safety items, i.e. Airbags, Knee Airbags, etc.

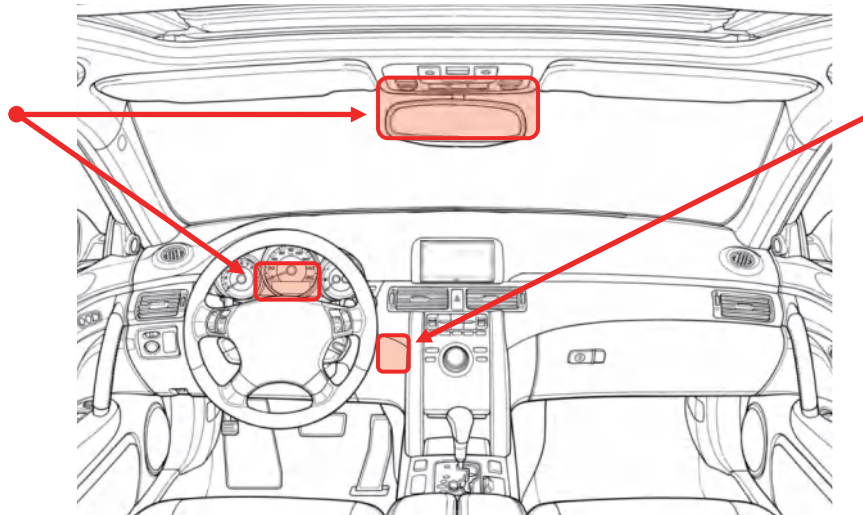

Steering Wheel Control Compatibility

SWC Introduction

Steering Wheel Control (SWC) function allows you to operate this unit via an external device (steering wheel control).

A third-party adapter must be used in order for this unit to be compatible with your OEM steering wheel controls. We recommend PAC SWC series.

This unit has a built-in 3.5mm SWC interface that is compatible with many popular 3rd party SWC control modules, such as PAC, METRA, and others.

3.5mm SWC input (red socket) is located on the supplied wire harness which is connected to the rear of the unit.

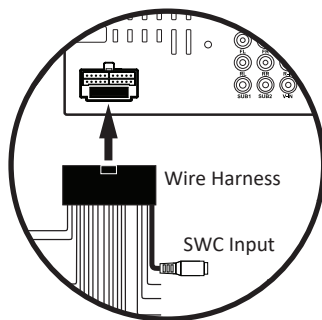

Illustration for reference only

Programmable Controls

The following radio / audio function controls are available to be programmed.

Source
Mute
Home
Seek + / Next Track
Seek - / Previous Track
Volume +
Volume -
Band
Phone Menu
Bluetooth Talk
Bluetooth End Call
Voice Assistant / PTT

i Note

Not all OEM steering wheel functions may be supported.

Specifications are subject to change without notice.

SWC Installation / Programming

Contact your local installation expert for the correct SWC adapter for your specific vehicle.

1. For most SWC adapters, select program using "Pioneer/Sony/Other" mapping order as described in "Programmable Control".
2. When programming, if a function is not supported (or not desired), then the function MUST be skipped as per the SWC module instructions.
3. The SWC function MUST be programmed in the correct order as per the function mapping order instructions.

i Note

For SWC programming technical assistance, call the number in your SWC instruction manual.

Troubleshooting

Issues	Cause	Solution
No sound	Internal amplifier is off Product is muted External amplifiers	Go to Settings > Audio > Internal Amp ON . Touch the volume. Check the external amplifiers are on. Check the remote output wire has voltage. Change the audio source.
Media not supported	Media on USB flash drive	Change the media format on the USB device. Change the USB device.
Poor radio reception	Radio area Antenna	Change the station. Antenna output wire is not connected. Connect Antenna to product.
Apple CarPlay/Android Auto unable to start	Bad Lightning®/USB cable Wi-Fi or Bluetooth disabled Wireless CarPlay/Android Auto connection disabled	Replace the cable for wired connection. Enable Wi-Fi and Bluetooth on your phone. Allow wireless CarPlay/Android Auto use when prompted during first time connection/pairing. For CarPlay use, make sure CarPlay is enabled on your iPhone (Settings > General > CarPlay > Paired device > Open CarPlay). Enable CarPlay/Android Auto connection (on the home screen, go to Handsfree > Device then tap the paired phone name).
Bluetooth streaming/phone call not possible	Bluetooth connection disabled	Make sure your mobile device is within range. Enable Bluetooth on your mobile device.

Troubleshooting

Issues	Cause	Solution
Bluetooth streaming/phone call not possible	Bluetooth connection disabled	Enable Bluetooth connection (on the home screen, go to Handsfree > Device then tap ⌘). For wired CarPlay/Android Auto connection, unplug the connection cable.
Hands-free call quality	Mobile device Microphone	Check cellular strength on mobile device. End call and redial number. Microphone placement needs to be relocated. Microphone needs to be firmly attached to location it's mounted on. Check to see if microphone is properly plugged in.
Unit is unresponsive	Processor has frozen	Restore the factory settings. Use a small pin to press the reset pinhole on the bottom of the display.



If you have questions about this product:

Customer Service

805-751-4853

M-F 8:30a-5:00p (PST)

Tech Support: www.bosssaudio.com/support/technical-support

© 2023 BOSS Audio Systems

Specifications

General

Power Input.....	8.5 V—18 V DC
Nominal.....	14.4 V DC
Current Consumption.....	15A
Fuse Type.....	15A
Dimensions (H x W x D).....	1.97" x 7" x 4.9"
Unit Weight.....	4.26 lbs.
Operational Temperature.....	-4—140°F

Display

Screen Size.....	10.1"
Aspect Ratio.....	16:9
Resolution.....	1024 x 600
Screen Type.....	TFT-LED Active Matrix

Audio

Max Power.....	85 W x 4
Acceptable Speaker Load.....	4-8 Ω
Preset EQ.....	5
JAZZ, HIPHOP, POP, ROCK, R&B	
EQ Bands, Adjustable.....	10
32, 63, 125, 250Hz, 500Hz	
1KHz, 2KHz, 4KHz, 8KHz, 16KHz	
EQ Boost/Cut.....	± 6 dB

Audio Cont'd

Pre-amp Output.....	3 Pairs
Front.....	4V, Full-Range
Rear.....	4V, Full-Range
Sub (Mono).....	4V, LPF
Sub LPF.....	50 Hz, 80 Hz, 120 Hz, 160 Hz
Sub Level.....	+1-14dB

Radio Tuner

Freq. Range.....	87.5 MHz-108 MHz (FM)
Freq. Range.....	522 kHz-1710 kHz (AM)
USA 1 Range (FM).....	100 kHz Spacing
USA 2 Range (FM).....	200 kHz Spacing
Europe Range (FM).....	50 kHz Spacing

Apple CarPlay

iPhone Support.....	iPhone 5 or Newer
iOS.....	iOS 7.1 or Newer

Android Auto

Wired.....	Android 6.0 or Newer
Wireless.....	Android 11.0 or Newer

USB

USB Spec.....	USB 2.0 (High-Speed)
USB Port 1: Carplay & Android Auto.....	Current Output 1.5A
USB Port 2: Media & 1.5A Charging	Current Output 1.5A
USB mass storage size	max 32GB
File System.....	FAT32
Audio Playback.....	MP3, WMA, WAV, FLAC (192kHz/24bit)
Video Playback.....	AVI, MKV, WMV
Picture Playback.....	JPG, PNG, BMP

* Not all listed compressed files guaranteed to play due to different creation methods or file contents.

Bluetooth®

Version.....	v4.2+E.D.R.
Audio Codec.....	S.B.C.
Profiles.....	
HFP v1.6, A2DP v1.2, AVRCP v1.5, PBAP v1.1	

Specifications are subject to change without notice.



BOSS Audio Systems
3451 Lunar Court - Oxnard, CA 93030
www.bossaudio.com
805-751-4853 Customer Service
Tech Support: www.bossaudio.com/support



0623

iPhone® is a trademark of Apple Inc., registered in the U.S. and other countries. Apple CarPlay is a trademark of Apple Inc. BOSS Audio Systems is not affiliated with Apple Inc.

The Bluetooth® word mark and logos are registered trademarks owned by Bluetooth SIG, Inc. and any use of such marks by BOSS Audio Systems is under license.

Other trademarks and trade names are those of their respective owners.

Android Auto is a trademark of Google LLC.

Use of the Apple CarPlay logo means that this user interface meets Apple performance standards. Apple is not responsible for the operation of this device or its compliance with safety and regulatory standards.

Please note that the use of this product with iPhone may affect wireless performance.