







ITEM: 6750-80151-85 Console Table

Thank you for purchasing this quality product. Be sure to unpack carefully looking for small parts which may have come loose during shipment.

Read all instruction and study the drawing carefully before starting the assembly process.

HARDWARE PACK				
NO.	DRAWING	DESCRIPTION	SIZE	Q'TY
A		Bolt	5/16"	32PCS
B		Lock Washer	5/16"	32PCS
C		Allen Wrench	73*29*5mm	1PC
D		Anti-Tip Kit		1PC

PART LIST			
NO.	DRAWING	DESCRIPTION	Q'TY
1		Console Table	1PC
2		Leg	8PCS

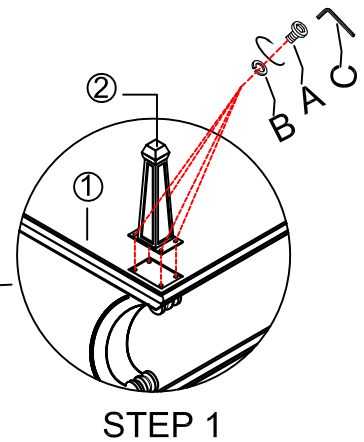
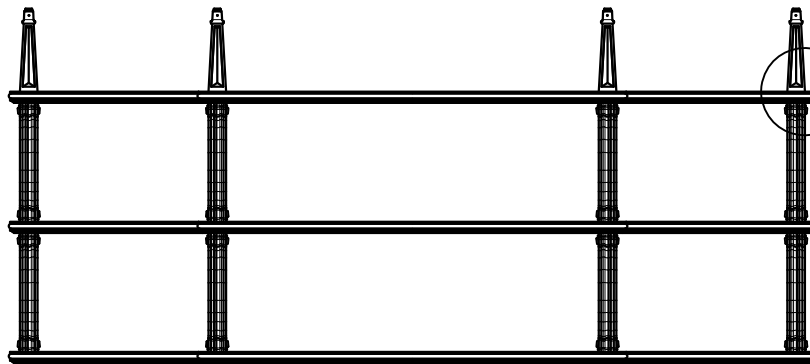

Tipping Restraint

Anti-tip kit is included for use. We recommend installing for safety reason

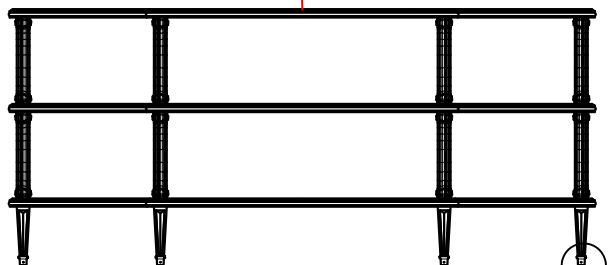
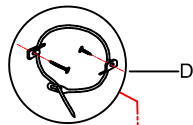

Adjust Leveler if needed to level case on uneven floor.

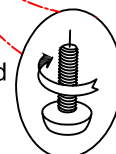

STEP 2