

# Swivel Chair

## IMPORTANT

Carefully remove all the parts from the carton and place them individually on a soft cloth to prevent scratches or other damage.

Carefully and strictly follow these assembly instructions to ensure a completed product as designed.

This product is made of aluminum. Do not use power tools above 8 volts to assemble and only tighten bolts until snug. Over tightening can damage the aluminum.

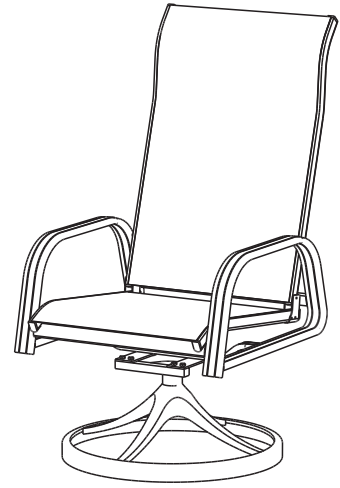

## Part List



A.  
Seat  
1 pc.

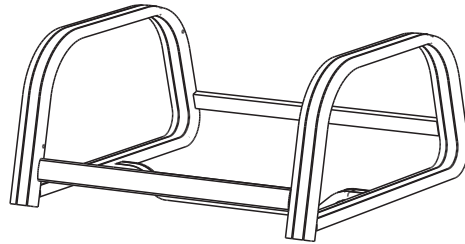

B.  
Frame  
1 pc.

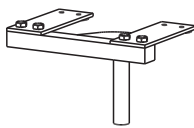

C.  
Connector  
1 pc.

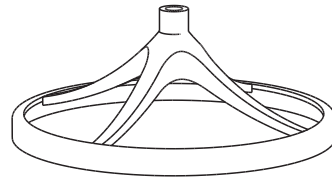

D.  
Base  
1 pc.

## Hardware List

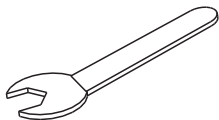

M6  
Wrench  
1 pc.

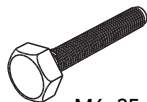

M6x35  
Bolt (small)  
4 pcs. (+1 extra)



Round Flat Washer  
4 pcs. (+1 extra)



Spring Washer (small)  
4 pcs. (+1 extra)



Small Cap  
12 pcs. (+1 extra)

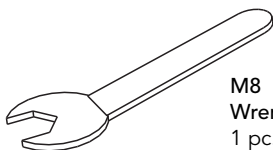

M8  
Wrench  
1 pc.

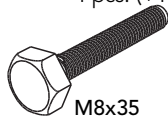

M8x35  
Bolt (large)  
4 pcs. (+1 extra)



Flat Washer  
4 pcs. (+1 extra)



Spring Washer (large)  
4 pcs. (+1 extra)



Nut  
4 pcs. (+1 extra)



Cap  
8 pcs. (+1 extra)

## Assembly Instructions 2/3

### IMPORTANT

- Use a soft cloth between these parts and the floor.
- Do not use power tools above 8 volts to assemble.
- Do not tighten all the bolts until each part is properly assembled.
- Keep Wrench as the bolts may need to be tightened in the future.

### STEP 1

Attach Frame (B) to Connector (C) with Bolts (large), Flat Washers, Spring Washers (large), and Nuts tightening bolts only halfway. (See Figure 1)

Tighten all Bolts (large) and Nuts.

Cover Bolts (large) and Nuts with Caps.

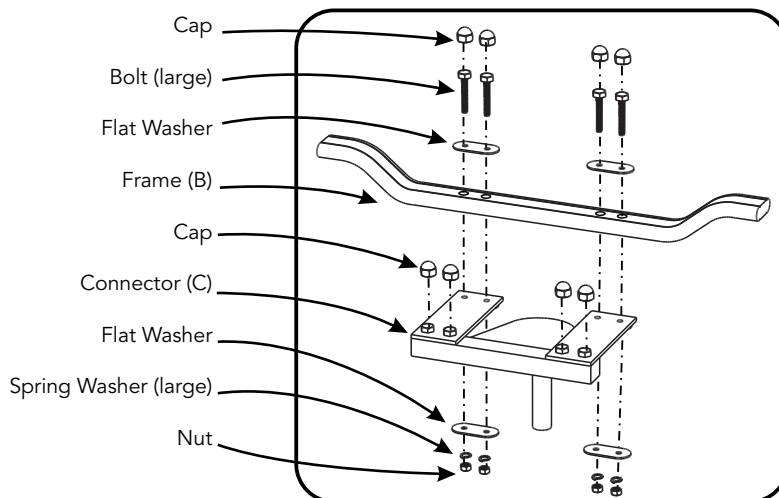
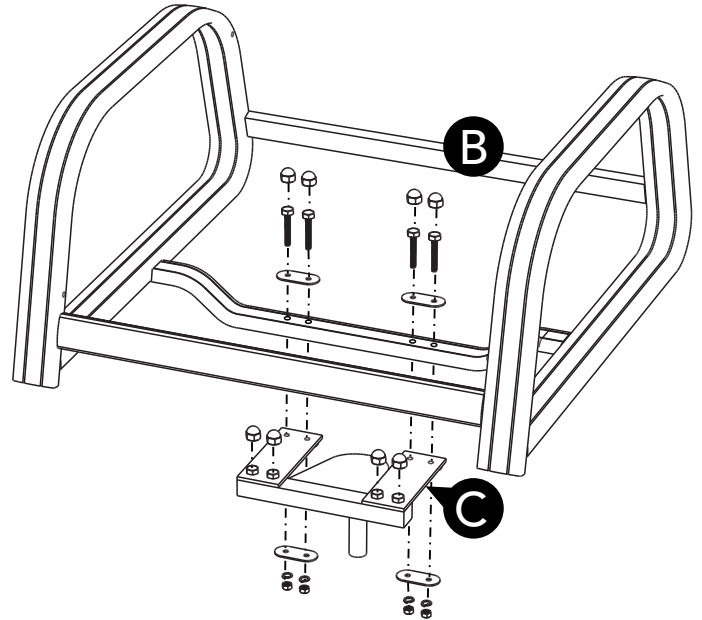
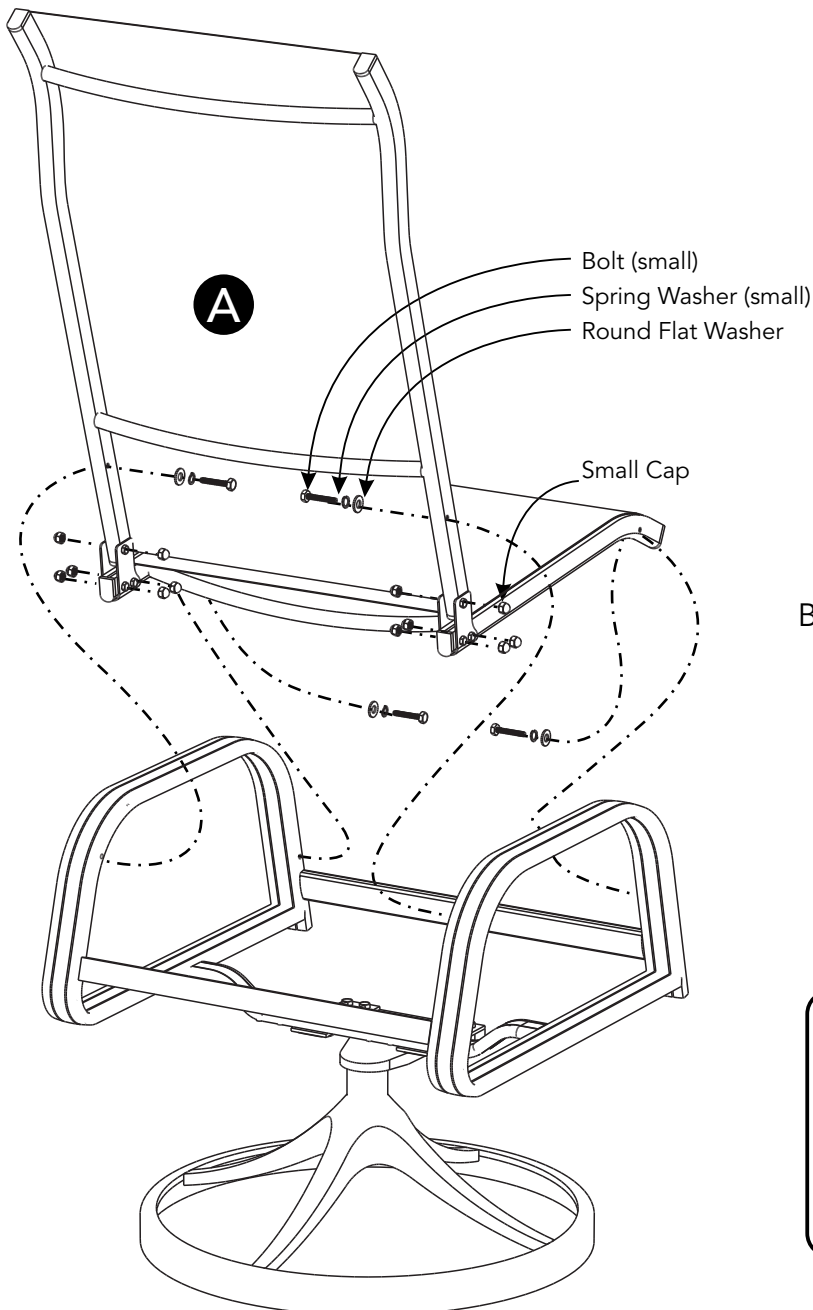
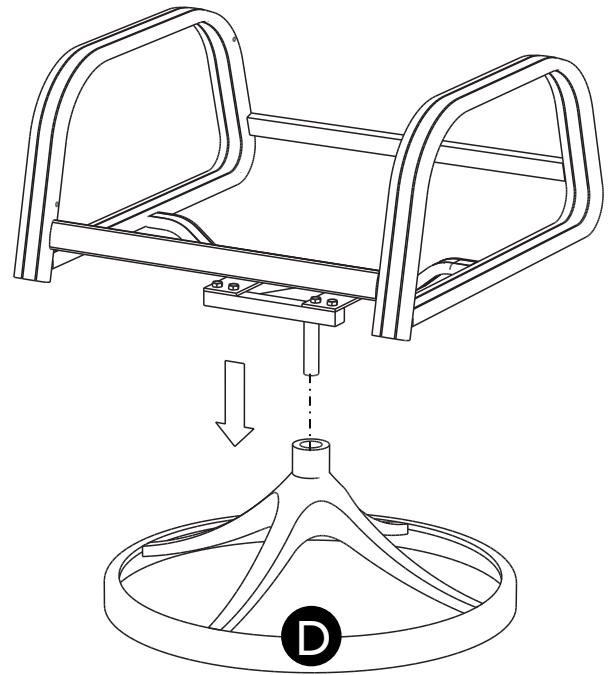

Figure 1

# Assembly Instructions 3/3

## STEP 2

Place unit onto Base (D).



## STEP 3

Attach Seat (A) to unit with Round Flat Washers, Spring Washers (small) and Bolts (small), tightening bolts only halfway. (See Figure 2)

Tighten all Bolts (small).

Cover seat bolts with Small Caps. (See Figure 3)

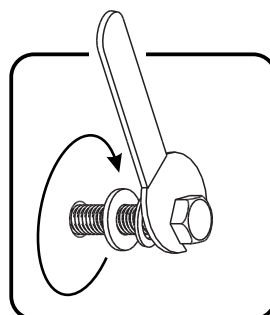

Figure 2

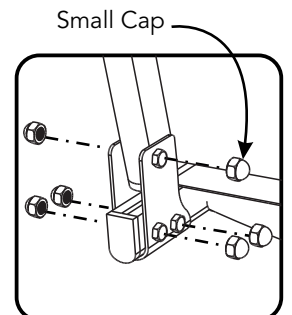

Figure 3

# CARE INSTRUCTIONS

## NEVER

allow liquids to remain on furniture.  
Absorption causes parts to warp  
and split and finishes to delaminate.

## NEVER

use glass cleaners on  
finished furniture. Ammonia  
chemically attacks the finish.



Do not use power tools  
above 8 volts to assemble.

**PREVENT  
CRACKING**

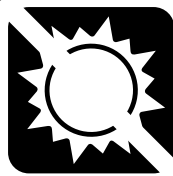

Do not place  
in direct sunlight.

**PREVENT  
FADING**



Do not write  
directly on surface.

**PREVENT  
MARKING**



Do not place hot  
objects on surface.

**PREVENT  
FINISH DAMAGE**

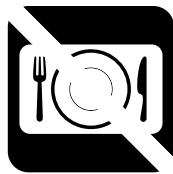

Do not use rubber  
based placemats.

**PREVENT  
DISCOLORING**



Do not use commercial  
waxes and polishes.

**PREVENT  
YELLOWING**

## CLEAN

with a soft cloth moistened  
in lukewarm soap and water.  
Buff with a dry clean cloth.



**homestyles** will provide replacements free of charge for missing or damaged parts within 2 years of purchase. Digital images of the defective parts may be required. If the product was not purchased from an authorized retailer, **homestyles** is under no obligation to provide replacement parts. Parts are not available for fully assembled items nor are parts available for sale. Replacements for missing or damaged parts may be requested via contact info below.

**homestyles** Customer Service: [www.homestylesfurniture.com](http://www.homestylesfurniture.com),  
[servicedesk@homestylesfurniture.com](mailto:servicedesk@homestylesfurniture.com), 888-680-7460