



Model VB25
OPERATORS MANUAL
Manual No. 513803



Dear customer,
we congratulate you for choosing a high quality product
which will surely satisfy your expectations.

With our thanks for choosing us,
we kindly invite you to examine the present operating
instructions manual before operating your new device.

SUMMARY

<p>1 IMPORTANT SAFETY ADVICES AND PRECAUTIONS 4</p> <p>2 SAFETY DEVICES 5</p> <p style="padding-left: 20px;">2.1 Lid's magnetic sensor 5</p> <p style="padding-left: 20px;">2.2 Extraction door's grill 5</p> <p>3 TECHNICAL DATA 5</p> <p style="padding-left: 20px;">3.1 Technical data plate and CE marking 5</p> <p style="padding-left: 20px;">3.2 Acoustic pressure level 6</p> <p>4 CARRYING AND UNPACKING 6</p> <p style="padding-left: 20px;">4.1 Transport of the packing machine 6</p> <p style="padding-left: 20px;">4.2 Unpacking 6</p> <p>5 INSTALLATION 7</p> <p style="padding-left: 20px;">5.1 Placing and checking of the parts 7</p> <p style="padding-left: 20px;">5.2 Machine's parts reassembling 8</p> <p style="padding-left: 20px;">5.3 Electric connection 8</p> <p style="padding-left: 20px;">5.4 Connection to the water network (devices with water condensation) 9</p> <p style="padding-left: 20px;">5.5 Initial functioning checking 10</p>	<p>6 MACHINE'S OPERATION 11</p> <p style="padding-left: 20px;">6.1 Warnings 11</p> <p style="padding-left: 20px;">6.2 Commands and indicators 12</p> <p style="padding-left: 20px;">6.3 Production 13</p> <p>7 PRE-WASHING 15</p> <p>8 WASHING 15</p> <p>9 MAINTENANCE 19</p> <p style="padding-left: 20px;">9.1 Maintenance during the disassembling of the parts 19</p> <p style="padding-left: 20px;">9.2 Checking of safety devices 19</p> <p style="padding-left: 20px;">9.3 Yearly maintenance 20</p> <p>10 PERIODS OF INACTIVITY 20</p> <p>11 MALFUNCTIONS 20</p>
---	--

WARNING:



**GENERAL/MECHANICAL
DANGER**



**DANGEROUS
VOLTAGE**

A TEXT IN UPPER-CASE, IDENTIFIED BY ONE OF THE SYMBOLS ABOVE, CONTAINS INSTRUCTIONS THAT, IF NOT FOLLOWED, MAY CAUSE HARM TO PEOPLE.



A text in lower-case, identified by this symbol, contains instructions that, if not followed, could cause damages or malfunctions to the device, or falls in its quality.

1 IMPORTANT SAFETY ADVICES AND PRECAUTIONS



CAREFULLY READ THE INSTRUCTIONS CONTAINED IN THE PRESENT OPERATING INSTRUCTIONS MANUAL BEFORE INSTALLING AND OPERATING THIS DEVICE. THESE INSTRUCTIONS HAVE BEEN DRAFTED FOR THE SAFETY OF INSTALLATION, OPERATION AND MAINTENANCE OF THIS DEVICE.

- The present manual of Operating Instructions, placed on the device in the packing and supplied with the Technical Handbook, the CE conformity certification and the electrical tests schedule, is an integral part of the batch freezer (also defined, in the present manual of operating instructions, simply with the term, device) and must be preserved for any future consultation.
- The Technical Handbook must always be given, together with the device, to the Assistance Service's personnel or to the technicians to whom you will eventually request assistance.
- In case of selling or transferring to other user, all the above mentioned documentation must be handed to the new user, so that he can be informed of the operation and relative technical informations and safety instructions.



DO NOT INTRODUCE YOUR FINGERS OR OBJECTS IN THE DEVICE'S LOOPHOLES.



DO NOT REMOVE OR HIDE, FOR ANY REASON, ANY LABEL APPLIED ON THE DEVICE.



NEVER OPEN THE PROTECTING PANELS. THE DEVICE DOES NOT CONTAIN, IN ITS INSIDE, PARTS WHICH CAN BE OPERATED BY THE USER.



THE USER MUST NOT EXECUTE OPERATIONS WHICH ARE NOT CLEARLY CONTAINED IN THE PRESENT USER'S MANUAL. ANY OPERATION WHICH REQUIRES TOOLS NOT GIVEN IN THE DEVICE'S EQUIPMENT IS TO BE CARRIED OUT ONLY BY THE ASSISTANCE SERVICE OR BY TECHNICALLY AUTHORISED PERSONNEL.

- Always unplug the device before undertaking any operation requiring access to the device's moving parts (beater, cylinder or extraction door).
- Any modification of the electric supply must be exclusively performed by qualified and certified personnel.
- Any use of the device that is not for the production of ice-cream, ice-cream cakes or slush, has to be considered improper.
- Do not connect and/or operate the device when any part is missing, except for specifically mentioned cases.
- The device has been made to be operated by adults, prohibit children to play with it.
- Modifying, or attempting to modify this device, can be dangerous and would void any type of warranty.
- Always use original spare parts.



It is important to adopt the following precautions to avoid damages to the cylinder, to the beater or any other mechanical part:

- Do not drop them and do not expose them to bumps;
- do not operate the refrigerator when the beater is not in the cylinder;
- do not operate the device dry, with a bad quality of mixture or in a quantity lower or higher than that one recommended: the liquids in the cylinder, in addition to the lubrication of its surface, keep the beater cool, uniforming its temperature.
- The beater and the cylinder are disposal built and paired with precision: for this reason they are very sensible to temperature changes, that may cause eventual damages to the mechanical parts of the device. NEVER expose to abrupt temperature changes the parts subject to refrigeration: DO NOT pour water (hot or cold) in the cylinder immediately after ice-cream has been produced.
- In the event of the use of the device being no longer required, deactivate the machine by severing the electric cable (after unplugging it from wall socket). In addition, follow these recommendations:
 - avoid dispersing the freezing gas and the oil contained in the device;
 - carry out the draining and/or recycling according to the local provisions of the law currently in force on this matter.

2 SAFETY DEVICES



DO NOT ALTER THE SAFETY DEVICES AND DO NOT UTILIZE THE MACHINE IF THE SAFETY DEVICES ARE DAMAGED OR MALFUNCTIONING.



THE MANUFACTURER IS NOT RESPONSIBLE FOR POSSIBLE DAMAGES CAUSED TO PEOPLE OR OBJECTS BY THE ALTERING OR BYPASSING SUCH DEVICES OR RELATIVE CIRCUITS.

2.1 Lid's magnetic sensor

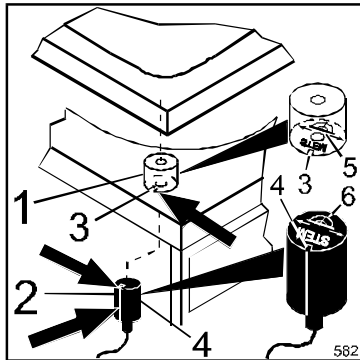

This safety device, featuring an approved type magnet [1] and a magnetic contact [2] avoids accidents caused by the accidental starting of the beater when the lid is open. In consequence the device can't operate when the lid is open, and if it is opened during its functioning the beater immediately stops.

In any case the lid's magnetic sensor **MUST NOT** be considered a control to be used for the normal stop of the device.



DURING THE NORMAL USE, THE DEVICE MUST BE STOPPED ONLY BY USING THE BUTTONS ON THE CONTROL KEYPAD, AND NOT BY OPENING THE LID.

The magnet [1] and the magnetic contact [2] **MUST** be assembled as follows: the grooves [3] and the stencilled semicircle [5] on the bottom of the magnet [1] must coincide with the grooves [4] (marked by a white line down the side) and the stencilled semicircle [6] on top of the magnetic contact [2]. **The device will not work unless all parts have been correctly assembled in accordance with these instructions.**

2.2 Extraction door's grill

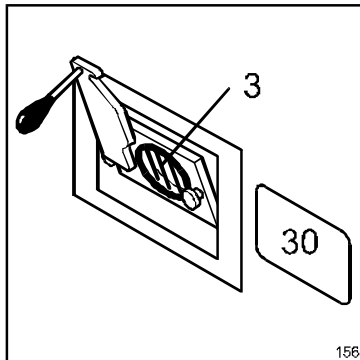

A fixed protection grill [3] prevents, as far as possible, fingers or objects from being **ACCIDENTALLY** inserted in the extraction pipe. In order to insure normal operation it is not possible to adjust the fixed grill as to prevent fingers and objects from being **VOLUNTARILY** inserted through the extraction pipe (**according to Machines Directive 89/392/CEE and ensuing modifications, Appendix I, Art. 1.1.2.b, 3rd paragraph**).



RESIDUAL HAZARD: DO NOT FOR ANY REASON INSERT FINGERS OR OBJECTS THROUGH THE GRILL OF THE EXTRACTION DOOR WHEN THE MACHINE IS IN FUNCTION.

The user is warned of the above **RESIDUAL HAZARD** (89/392/CEE and ensuing modifications, Appendix. 1, Art. 1.1.2.b, 3rd paragraph and 1.7.2) by a label [30] affixed next to the extraction door.



DO NOT HANDLE OR REMOVE THE GRILL [3] FROM ITS SEATING IN THE EXTRACTION DOOR!

3 TECHNICAL DATA

3.1 Technical data plate and CE marking

	MODEL	(2)		
	S/N	(3)	YEAR	(4)
	V	(5)	Hz	Ph
	COOLING	(6)	Kw	(7) A (8)
	GAS	(9)	gr/oz	
	LOW-SIDE (PSIG)	(10)	HIGH-SIDE (PSIG)	

The technical data plate and CE marking must not be removed. It is placed on the back side of the device and identifies:

- the name and address of the manufacturer [1];
- the designation of the model [2];
- the relative serial number [3] and the year of construction [4];
- the values of voltage and frequency [5];
- the type of cooling [6], the power [7] and current [8] consumption;
- the type and quantity of freezing gas contained [9];
- the values of high and low pressure [10] and the CE marking [11].

3.2 Acoustic pressure level

The average equivalent continuous acoustic pressure level of this machine is quoted in the Technical Handbook (Technical Data section). This data has been measured at 1 meter from the surface of the machine and at 1.60 meters from ground-level, during the machine's functioning.

4 CARRYING AND UNPACKING

Note: We suggest you to let the Assistance Service or qualified technicians carry out the transportation, unpacking and installation.

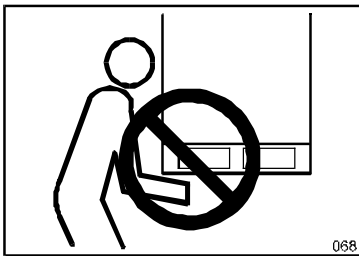

TO LIFT THE MACHINE ALWAYS USE AN ADEQUATE LIFTING DEVICE. ATTEMPTING TO LIFT IT MANUALLY IT'S DANGEROUS AND IT CAN DAMAGE YOUR HEALTH.

The machine's weight specifications, both including packing and net, can be found in both the supplied documents and on the packing itself.



To prevent the oil contained in the compressor to flow into the refrigerating circuit, it is necessary to always keep the machine in upright position, during carrying, installation and operation. Always follow the instructions on the packing.

4.1 Transport of the packing machine

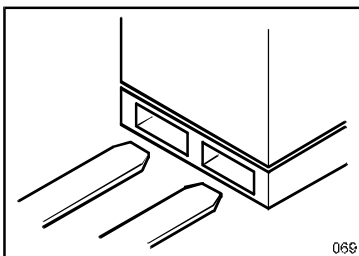

The packing has been designed to assure to the machine the highest safety.

It is therefore suggested to transport the machine while it is packed as near as possible to the place where it will be installed.

To carry the packing machine, use an elevator, or a bench trolley, inserting its forks in the basement's holes.

4.2 Unpacking

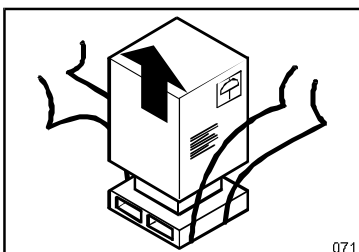

Unpack the machine and carefully check it. In case of doubt, do not use it, and call the Seller.

- cut the straps and remove the cardboard box from the top;

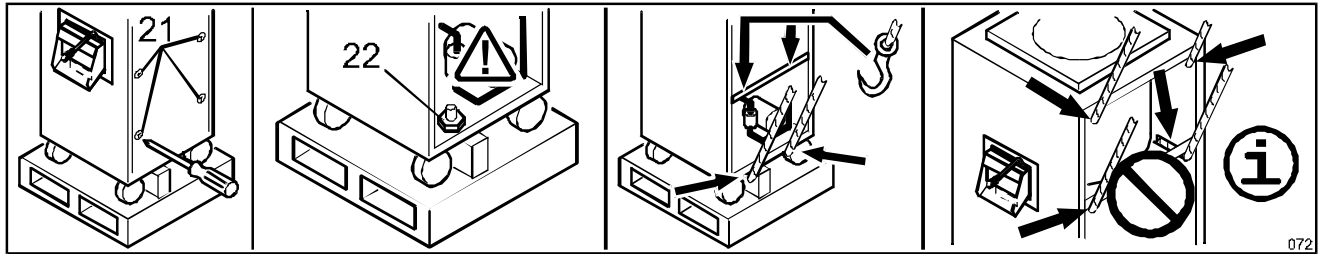

THE OPENING OF THE LATERAL PANEL IS ONLY ALLOWED TO THE ASSISTANCE SERVICE OR TO QUALIFIED TECHNICIANS AND MUST BE MADE BEFORE CONNECTING IT. MAKE SURE NOT TO DAMAGE THE INSIDE PARTS OF THE DEVICE.

- Remove both the lateral panels unscrewing the relevant fixing screws [21];
- Find and unscrew the bolts [22] which fix the machine's frame at the packing's basement;



The outlet of the supply cable is placed on the machine's lower side. During the lifting make sure not to damage it.

- Lift the machine from the basement, possibly working on the lower side, near the wheels, and however, only on the frame's carrying parts. Remove the basement, and lean the machine on the floor avoiding bumps;



DO NOT insert objects, ropes or brackets for the lifting THROUGH the machine, since those could damage the inside parts.

- Re- close the lateral panels;
- Replace or move the packing, which is produced with entirely recyclable materials (♻️)

5 INSTALLATION



THE INSTALLATION MUST BE CARRIED OUT ONLY BY THE ASSISTANCE SERVICE OR BY TECHNICALLY AUTHORISED PERSONNEL AND IN COMPLIANCE WITH THE LAWS IN FORCE, ALWAYS FOLLOWING INSTRUCTIONS OF THE MANUFACTURER.

5.1 Placing and checking of the parts

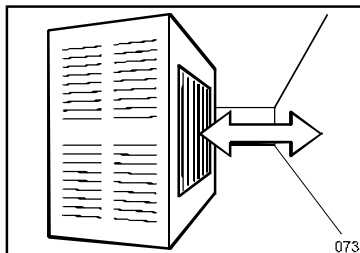

Place the device on the floor, on a flat and steady surface.

Install the device away from any source of heat, avoiding a direct exposition to sun radiation and making sure that air can freely circulate around each side of the device itself.



The devices with AIR COOLING need at least of 50 cm free space in front of the condenser's grill, to assure the refrigerating system a correct functioning. Further information are reported on the Technical Book (Technical Data section).

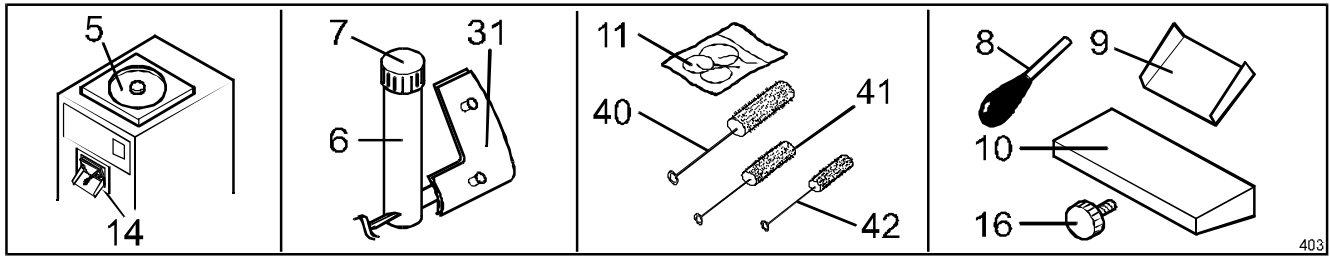

Check that the following items are all included in the package:

- lid [5];
- beater [6], correctly fixed inside the cylinder with its knob [7] and supplied with adjustable blades [31] (1...3 according to the model);
- extraction door [14];

Also check that the following items are included:

- spare part kit [11], big brush [40], medium brush [41], small brush [42];
- basin support [10], knobs [16], the lever [8] and the extraction door chute [9];
- all the **technical documentation** (in addition to this handbook): the Technical Handbook, the EC Conformity Certification and Electric Test Schedule.

5.2 Machine's parts reassembling



THE REASSEMBLING MUST BE MADE BEFORE CONNECTING THE MACHINE TO THE ELECTRIC SUPPLY SYSTEM.

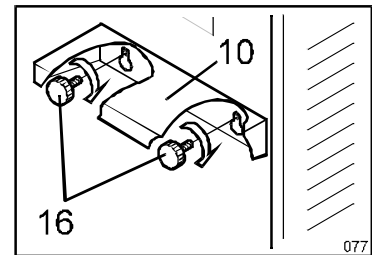
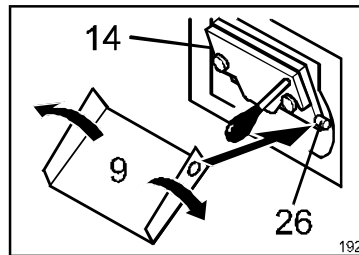
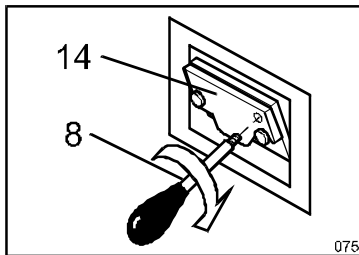

- Screw the lever [8] in the extraction door [14];
- if the chute [9] is supplied disassembled, install it under the extraction door [14] by hooking it to the hinges [26];
- install the basin support [10] by fixing it to the front panel with knobs [16].

5.3 Electric connection



THE SUPPLY'S VOLTAGE REQUIRED BY THE DEVICE IS HIGH, SO, IT IS PARTICULARLY DANGEROUS. THE WORKS ON THE SUPPLY'S ELECTRIC CIRCUITS MUST BE MADE WORKMANLIKE BY QUALIFIED STAFF.

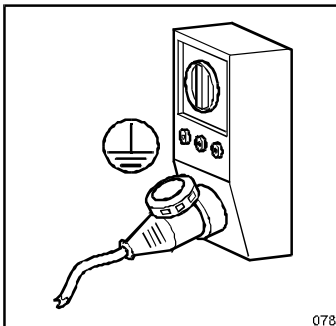

THE ELECTRIC SAFETY OF THIS AUTOMATIC DEVICE IS REACHED ONLY WHEN THE SAME IS CORRECTLY CONNECTED, BY QUALIFIED AND CERTIFIED PERSONNEL, TO AN EFFICIENT EARTHING SYSTEM, MADE AS PROVIDED FOR IN FORCE SAFETY REGULATIONS.

The manufacturer must not be considered responsible for eventual damages caused by an inadequate electric or earthing system.

All the electric device's features required for the system's proportioning are reported on the Technical Data Plate and on the Technical Handbook.



FOR PREPARING THE ELECTRIC SYSTEM WHICH SUPPLIES THE DEVICE, IT IS COMPULSORY TO FOLLOW THE PRESCRIPTIVE STANDARDS IN FORCE. IN PARTICULAR:

- The electric capacity of the system must exactly match the supply's voltage and frequency required by the device;
- the current capacity of the system must be suitable for the device's input;
- the system must end with an accepted 4 pole electric socket and with electric and mechanical suitable characteristics. The electric socket's poles must be marked with appropriate letters (phases R- S- T + earth); the earth's pole must be recognizable;
- the electric socket must prevent, through appropriate mechanical measures, the plug's wrong connection;
- the electric socket must have, above or annexed, a breaker, conformed to the in force safety laws, with an associated gearing placed near the device, in a position easily reachable by the operator. It must also be protected by fuses, above or annexed, with characteristics suited at the current absorbed by the device.



A WRONG CONNECTION ON THE EARTH TERMINAL MAY CAUSE SERIOUS DANGER.

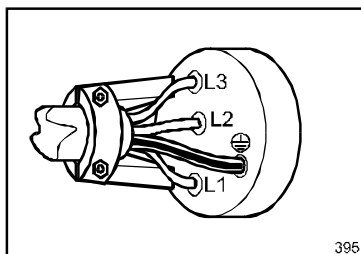

A 4 pole plug, suitable with the current socket, must be installed at the end of the device's power supply cable.

The device's power supply cable is composed by 4 coloured wires, and eventually marked with appropriate bands, which must be connected to the relevant plug's terminals, as shown in the following table.



A WRONG CONNECTION IN THE PLUG'S INSIDE MAY CAUSE SERIOUS DANGER. FOR THE CONNECTION, ONLY ADDRESS YOURSELVES TO QUALIFIED AND AUTHORIZED TECHNICIANS.

Kind of supply	Wire colour	Wire marking band	Code marked near plug's terminal
EARTH	GREEN/YELLOW	None	PE or \perp
Phase R	BLACK	OR	R or L1
Phase S	BROWN	OS	S or L2
Phase T	BLACK	OT	T or L3



Before using the device it is necessary to:

- connect it to the water network, if the device features a water condenser (Ref. Par. 5.4);
- carry out the initial functioning checking (Ref. Par. 5.5).

5.4 Connection to the water network (devices with water condensation)

If your device features water condensation, it is necessary to prepare tubes for the feeding and draining of the water.



Do not let water from a TOWER in, unless they have been specifically designed to utilize water from a tower. Unless otherwise specified, the machine is designed to utilize water from a WELL.

Note: the correct water temperature to start the machine is specified in the Technical Handbook, Par. "Technical data".



The use of below standard tubes and connections may cause water drops, with consequent inconveniences for Your laboratory and, if the drop is abundant with squirts, it damages the device.

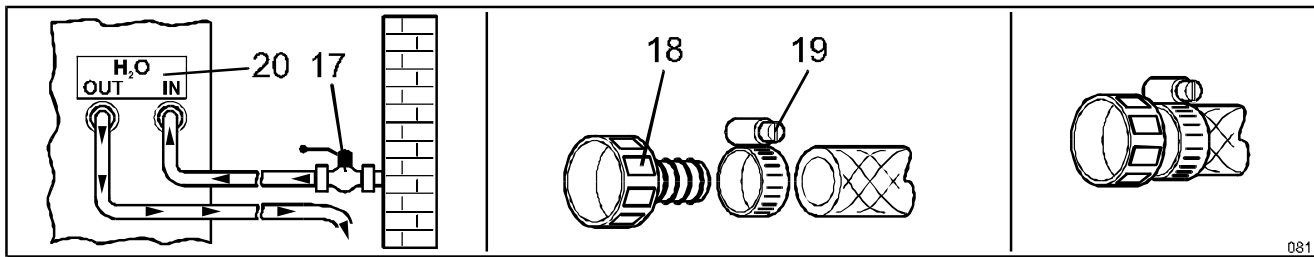

Use linen- rubber tubes for water connection, arranged for 15 Bar pressures, interposing a valve or a faucet [17] **ABOVE** the delivery pipe; use a 3/4" rubber holder [18], well fixed with a proper band [19] to connect the tubes at the device's union.

Note: Tubes for the water feeding of households are on the market (ex. dishwashers) which, in addition to being cheap, feature the requested characteristics and are predisposed with a rubber holder.

The unions are placed on the back panel of the device, they are marked by a plate "H₂O" [20] and are labelled with:

IN: INLET of fresh water in the device;

OUT: OUTLET of water used by the device.



Follow the following precautions to avoid damages at the device's water circuit:

- do not invert the connection of tubes;
- if water in the area presents a high quantity of spur, install a suitable decalcification or filtration device above the delivery pipe;
- if not otherwise mentioned in the Technical Handbook, the incoming water's pressure must be comprehended between 1.5 and 6 Bar (ideal pressure: 3 Bar). If the pressure in the device is higher, it is necessary to interpose a pressure limiting device, appropriately regulated, above the delivery pipe.



AVOID CONSTRICTION OR NARROW TURNS OF THE TUBES.

Note: The water outcoming the condenser, though being hot and not drinkable, is not polluted and can be reutilised.



Before storing the device in rooms with a temperature lower than 0°C it is **INDISPENSABLE** to get rid of the water in the condenser and in the inlet and outlet pipes. Call the Assistance Service.

5.5 Initial functioning checking



At the end of the installation, and before utilising the device, it is indispensable to let a qualified technician checking the correct connection, by performing the following procedure.

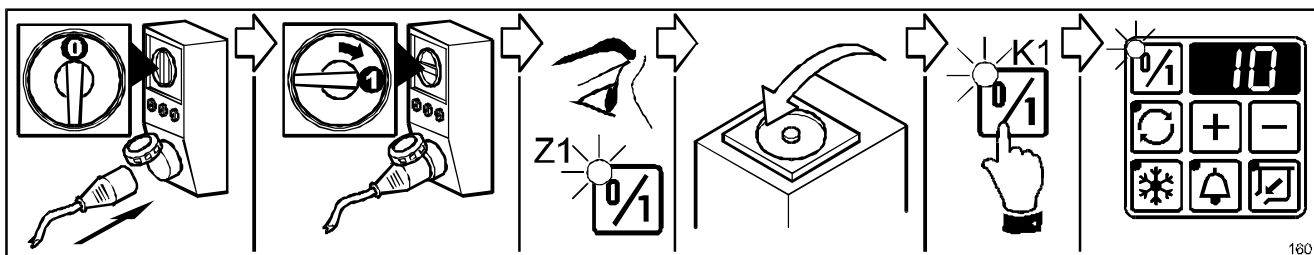

- Before starting, check that the socket's breaker is in the position "0";
- Insert the plug in the socket, and put the general Breaker in position "1";
- only the green indicator on the ON/OFF Pushbutton [Z1] on the control panel must turn on;
- close the cover and press the ON/OFF Pushbutton [K1]. The device predisposes itself for functioning and the display shows the total time previously set (in prime minutes);



Remove the beater from the cylinder before carrying on the checking, to avoid letting it function dry. **ATTENTION:** Follow the directions reported on Par. 7.2 - Disassembly of parts.

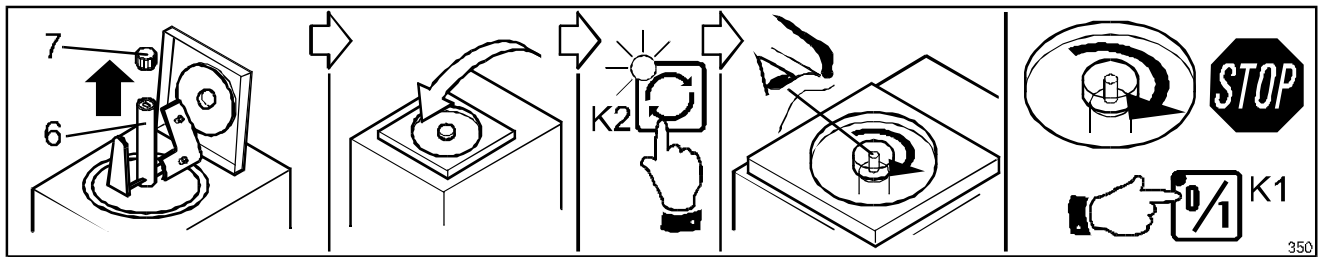

- Open the lid, unscrew the fixing knob [7], pull out the beater [6] from the cylinder, then close the lid.

Note: The device will not operate when the lid is open.

- Press the BEATING Pushbutton [K2] and check that beater's shaft turns CLOCKWISE (as shown in the picture). In this case, the device is correctly connected and ready to be used;

Note: do not unnecessarily start the refrigerating system.

- If the rotation is COUNTERCLOCKWISE, the connection to the three-phase electrical supply is wrong, and must be changed proceeding as follows:

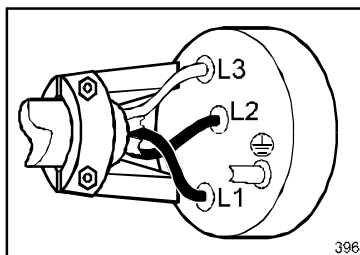

- Turn off the device by pressing the ON/OFF Pushbutton [K1];



TURN THE SOCKET'S BREAKER ON "0" POSITION, THEN UNPLUG THE MACHINE;

- Open the plug's shell and invert TWO of the THREE conductors connected at the phases (R- S, R- T or S- T);
- Close the plug's shell, plug in the device and repeat the checking.

6 MACHINE'S OPERATION

6.1 Warnings



WHEN USING THE DEVICE, AS WITH ALL ELECTRICAL APPARATUS, ESSENTIAL RULES MUST BE COMPLIED WITH, PARTICULARLY:

- never touch it if your feet or hands are wet;
- never operate it while barefoot;
- never pull the supply cable to disconnect it from the main network;
- avoid liquids to penetrate in the device, for example during its cleaning;
- forbid children and unable people to operate it.

In case of failure and/or malfunctioning of the device - and every time you notice damages, mainly at the supply cable or at the safety devices - turn off the power supply. Contact qualified and certified personnel for assistance.



NEVER operate the machine in DRY conditions or with an amount of mixture other than the one recommended.



NOT RESPECTING THESE RULES, IN ADDITION TO VOIDING ANY FORM OF WARRANTY, CAN SERIOUSLY COMPROMISE THE SAFETY, PERFORMANCES AND FUNCTIONING OF THE SAME DEVICE.

6.2 Commands and indicators

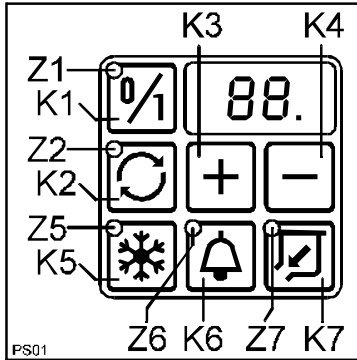

All commands and indicators for the use of the device are grouped in a single control panel placed on the frontal panel. Its functioning is electronically managed in low voltage.

In this manual, the buttons and indicators are identified with the relative symbol, and/or with an imprint ([K...] for pushbuttons, [Z...] for indicators).

The functioning of every command is described hereby: to obtain the best results, an acknowledgment is suggested.



ON/OFF Pushbutton [K1]

When the electric supply is connected, the machine is ready to be turned on, the green indicator light [Z1] is on. By pressing the button, the device turns on and the other buttons are enabled. The display shows the total refrigerating time previously set (in prime minutes).



SETTING Pushbuttons [K3] - [K4]

By pressing these commands, the number of minutes visualised on the display will be increased or decreased (1...99).

Note: It is suggested to set the refrigerating time when the device is idle, generally between 8 and 12 minutes depending on the kind and quantity of the mixture. It is possible to increase or decrease the timing even during the refrigeration for particular needs.

In any case the timer will automatically memorise, as total time, the minutes VISUALISED ON THE DISPLAY after having pressed one of the setting pushbuttons.



BEATING Pushbutton [K2]

By pressing the pushbutton, the rotation of the beater goes CLOCKWISE. Press again the pushbutton to stop the beater.

The relative lighted indicator [Z2], signals that the beater is rotating CLOCKWISE.

Note: Pressing the BEATING Pushbutton when the REFRIGERATION command is activated ([Z5] indicator lighted) stops the refrigeration, and the timer is put in PAUSE. By pressing again the pushbutton to start the beating, the refrigeration starts again.



REFRIGERATION Pushbutton [K5]

By pressing the pushbutton (after having set the timer) what follows will be commanded:

- The start up of the refrigerating system (the [Z5] indicator of this button lights up);
- The beating, automatically, clockwise (the BEATING indicator [Z2] lights up)
- The timing control, signalled by the flashing spot visualised on the display, at the left of the residual refrigerating time.

The relative indicator [Z5], when lighted, indicates that the refrigerating system is activated. It remains in function until:

- a new pressure of the REFRIGERATION Pushbutton, or that of the BEATING Pushbutton [K2];
- at the end of the pre- set time on the timer. In this case the timer remains in function to avoid the formation of ice on the cylinders walls (the [Z2] indicator is still lighted). To stop it, press the BEATING Pushbutton [K2].



EXTRACTION Pushbutton [K7]

Press this button to let the ice-cream goes out from the extraction door. This happens by rapidly rotating the beater COUNTERCLOCKWISE. The refrigerating system is automatically shut down to avoid the formation of ice.

Note: It is always suggested to wait for the end of the cycle ([Z5] indicator off) or stop the refrigeration by hand using the REFRIGERATION Pushbutton [K5] before commanding the extraction.



To avoid excessive stress, before commanding the extraction, it is necessary to OPEN THE EXTRACTION DOOR.

The [Z7] indicator signals that the beater is in functioning COUNTERCLOCKWISE.

Press this button once again in order to complete the extraction cycle.



BUZZER Pushbutton [K6]

The device features a buzzer which rings when the processing time has come to an end. To activate it, press this button (the [Z6] indicator lights up).



Digital display

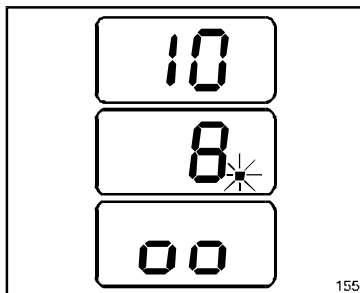

- When the device is not functioning, the display shows the total refrigerating time previously set (in prime minutes);
- When the device is in refrigeration cycle, the display shows the residual refrigerating time and a flashing spot;
- when it shows "oo" (two small squares) it indicates a machine failure:
 - the lid is not correctly closed;
 - the chute with protection flap is not correctly installed;
 - a safety device has come into operation. See Section 10 - Malfunctions.

6.3 Production

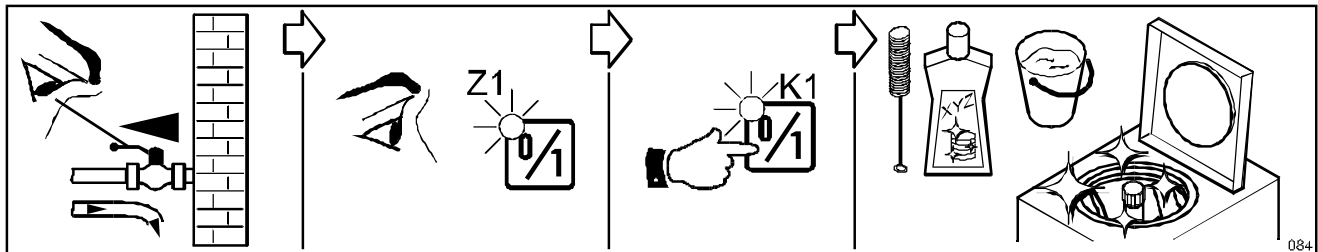

In devices with water condensation, check that the condensation water's faucet is open;

- check that the ON/OFF Pushbutton's indicator [Z1] is lightened. If not, check that machine is plugged in and Main Breaker is turned on (on "I");
- **Check the lid is closed and the chute with protection flap is in position, otherwise the device will not operate. NO "oo" (two small squares) should show on the Display;**
- press the ON/OFF Pushbutton [K1].



Do not press the BEATING [K2] or REFRIGERATION [K5] Pushbuttons before having introduced liquids in the cylinder. The beater must not function dry, otherwise it will be damaged.

- before beginning the production proceed with rinsing, washing and sanitization using a detergent and sanitizing solution (see Sections 7 PRE- WASHING and 8 WASHING).

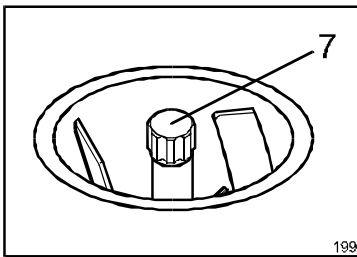

Note: If you plan to have more than one consecutive production cycle, you can avoid the washing between a cycle and the other, making sure you begin with the clearer mixtures.



Before operating beater, ALWAYS check that beater's fixing knob [7] is FIRMLY TIGHTENED and the gasket is intact and clear of any fat. Should the knob accidentally coming lost and falling into the cylinder while operating, this would cause serious damages to the machine.

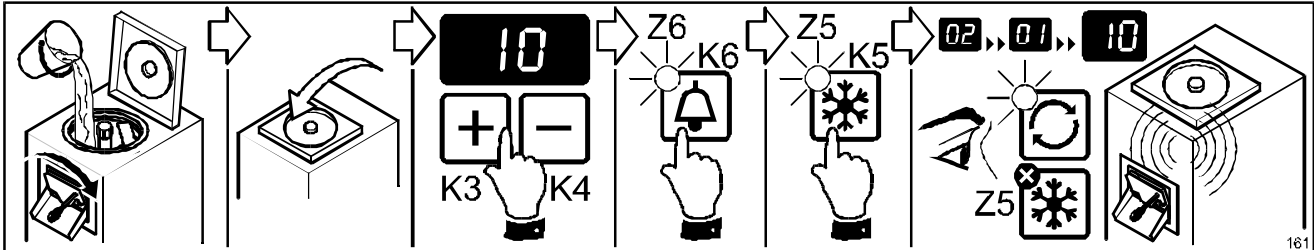

- check that the extraction door is firmly closed and pour mixture in the cylinder. Only use suitable perfectly preserved ingredients, in the correct amount. The maximum and minimum amounts are indicated in the Technical Handbook, in the "Technical Data" section.



Unsuitable mixture or insufficient amount of it can cause the formation of ice, and cause damages or irregular functioning at the cylinder and beater, while an excessive quantity of mixture can forbid the correct refrigeration, in addition to causing an excessive stress to the motor and beater and overflows of product.

- Close the lid of the beater;
- regulate the refrigerating time following your experience, by pressing the SETTING Pushbuttons ([K3] and [K4]) and reading the value (in minutes) on the display. Generally 8 to 12 minutes of refrigeration are necessary, in function of the quality and quantity of the mixture;
- press the BUZZER Pushbutton [K6] to activate the buzzer at the end of the refrigerating cycle (the relative indicator [Z6] lightens);
- press the REFRIGERATION Pushbutton [K5];
- wait the end of the functioning, signalled by the shutting down of the REFRIGERATION indicator [Z5] and the eventual acoustic signal.

Note: If it is necessary to add some ingredients during the refrigerating cycle, stop the beater by pressing the BEATING Pushbutton [K2]. In these conditions the timer is in PAUSE and the residual time memorised. To restart the refrigerating cycle, press the button once again.

At the end of the refrigerating cycle, the ice-cream is ready to be extracted:

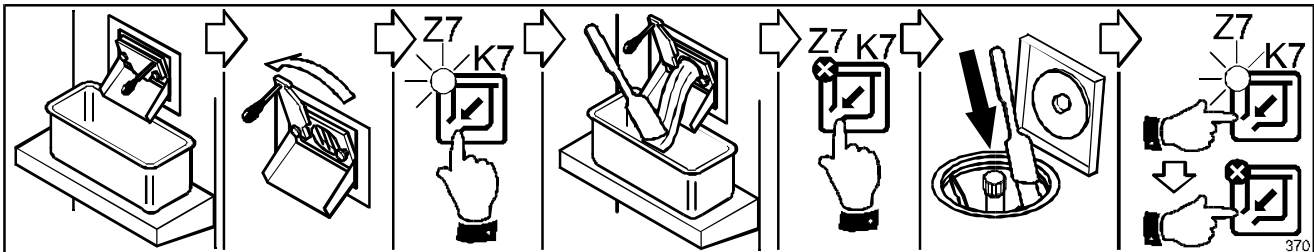

- place an idoneous basin on the support;
- open completely the extraction door and press the EXTRACTION Pushbutton [K7]. Make easy with a suitable spatula the settlement of the ice-cream in the basin;
- stop the beater by pressing the EXTRACTION Pushbutton [K7];
- open the lid and detach the ice-cream eventually left on the beater's blades (by using the featured spatula letting it settle on the bottom of the cylinder.
- press the EXTRACTION Pushbutton [K7] to extract the residual ice-cream;
- stop the beater by pressing the EXTRACTION Pushbutton [K7] and close the extraction door.

7 PRE-WASHING

i Do not carry out the rinsing having a very cold cylinder.

- Proceed with rinsing to eliminate the residual ice-cream, using 2 gal. of warm water (30°C), if you soon will produce other ice-cream;
- Proceed with rinsing to eliminate the residual ice-cream, using 2 gal. of warm water (30°C) and, if the production has come to an end, proceed with simple washing, accurate washing and disassembling of the parts (see 8 WASHING).

8 WASHING



THE FATS CONTAINED IN THE ICE-CREAM MIXTURES ARE IDEAL FOR THE GROWTH OF BACTERIA. WE RECOMMEND TO WASH AND SANITIZE WITH THE MAXIMUM CARE EVERY PART IN CONTACT WITH PRODUCT, IN ACCORDANCE WITH CURRENT HEALTH REGULATIONS.



For a long life of the device we suggest not to use solvents, abrasive detergents, or rough sponges, in particular on the plastic and rubber parts. During the washing operations and in particular during the rinsing, activate the beating only for the suggested periods. Otherwise you could damage the machine. **DO NOT** press the REFRIGERATION Pushbutton [K5] during the washing. Otherwise you would freeze the water and break the parts of the machine. Do not press the EXTRACTION Pushbutton [K7] because all the washing solution would come out from the top of the machine. Do not carry out the washing having a very cold cylinder.

CARRY OUT THE WASHING OF THE DEVICE FOLLOWING THESE PROCEDURES:

1 Simple washing

STEP 1

Prepare a pail with a solution composed by 2 gal. of hot water (50°C) and 1 oz. of detergent GOLDEN GLO by SPARTAN CHEMICAL.

STEP 2

Check that the extraction door is closed, open lid, pour the detergent solution in the tank and close the lid again.

STEP 3

Press the beating pushbutton [K2], this will cause the detergent solution to be agitated in the tank.

STEP 4

2 minutes later, press the beating pushbutton [K2] again to stop the agitation, place a pail beneath the extraction door and clear out the tank.

STEP 5

Rinse only with hot potable water (50°C), repeating steps 2, 3, 4 until the rinse water being drawn from the tank is clear.

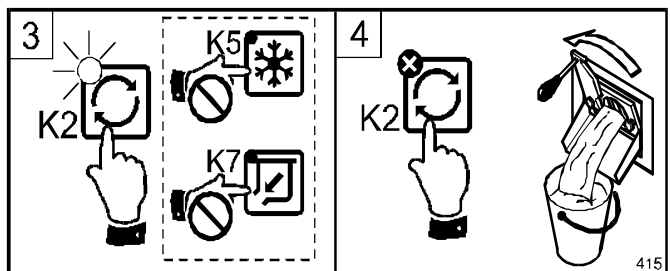
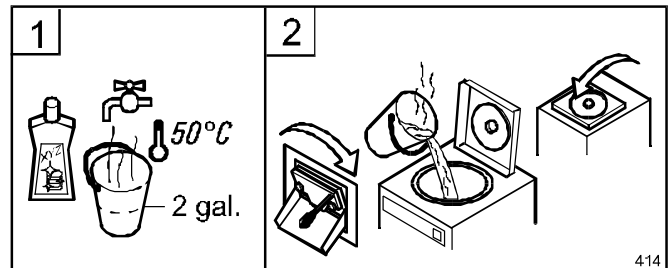

2 Accurate washing and disassembling of the parts



CARRY OUT THESE OPERATIONS ONLY WITH THE SOCKET'S MAIN BREAKER ON "0". THE [Z1] INDICATOR OF THE IGNITION BUTTON ON THE CONTROL PANEL MUST BE TURNED OFF.

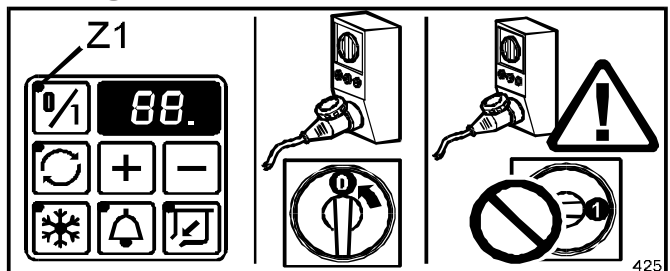

STEP 1

- extract the rod [25] from the lid's hinge and remove the lid [5];



RESIDUAL HAZARD: BEATER'S BLADES ARE SHARP ALONG BOTTOM AND EXTERNAL SIDE EDGES. IT IS RECOMMENDED TO USE SUITABLE PROTECTIVE GLOVES AND TO HANDLE THE BEATER ONLY BY HOLDING THE CENTRAL HUB AND NOT THE BLADES.

- Unscrew counterclockwise the fixing knob [7] and extract the beater [6];
- remove the basin support [10] by unscrewing the hand screws [16];
- unhook chute [9] from hinges [26] and remove it;
- remove the scraping blades [31] from the beater [6];
- unscrew counterclockwise the 2 fixing knobs [41] and remove the extraction door [40], taking extremely care not to damage its surface and not to lose its parts .



TAKE CARE NOT TO ALLOW WATER OR ANY LIQUID INSIDE THE MACHINE.

STEP 2

Prepare a pail with a solution composed by 1 gal. of water and 1/4 oz. of disinfecting SANI- T- 10 manufactured by SPARTAN CHEMICAL and carry out the cleaning of the underlisted parts, using the provided brushes as illustrated in the drawings.

- the beater [6] and the fixing knob [7];
- the beater's blade [31];
- the lid [5];
- the chute [9];
- the drip tray support [10];
- the locking door [40]

STEP 3

Prepare a pail with a solution composed by 2 gal. of water and 1/2 oz. of disinfecting SANI- T- 10 manufactured by SPARTAN CHEMICAL and immerse for at least 5 minutes the underlisted parts:

- the locking door [40];
- the fixing knob [7];
- the beater [6]
- the beater's blade [31];
- the chute [9];

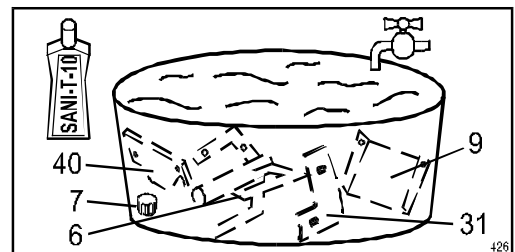
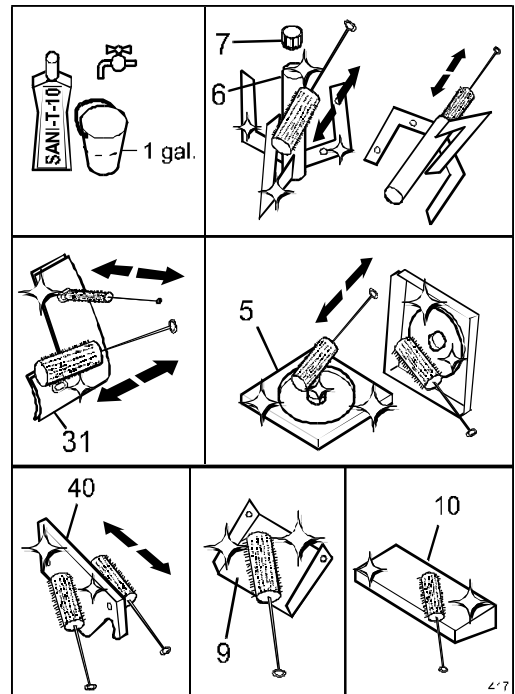
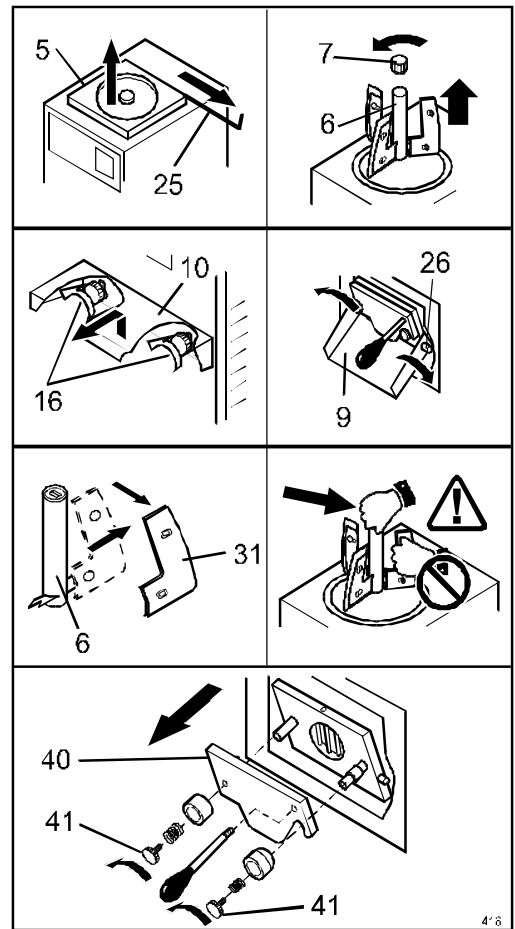

STEP 4

Before reassembling the components, accurately wash the fixed parts of the device as illustrated in the drawings and underlisted, using the solution previously prepared (see STEP 2).

- the extraction pipe, the safety grill, the groove and its edges using the provided brush
- the upper surface, the lid's rod and the inside of the tank;

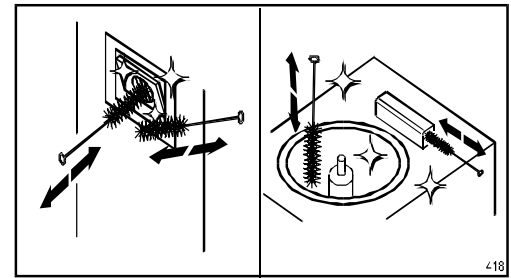

STEP 5

A potable water rinse is not necessary unless so specified by state or local ordinance.

3 Reassembly



THESE OPERATIONS MUST BE CARRIED OUT ONLY WITH THE SOCKET'S MAIN BREAKER ON "0"

STEP 1

After carrying out the washing as previously described, reinstall the machine's parts as follows:

- Assemble the scraping blades [31] on beater's supports [6].



Carefully place the beater into the cylinder, taking care to keep it vertical without dropping it.

- The slot on the beater's hub [27] goes into the shaft clutch [28];



Before tightening knob [7], always check that the gasket [G] is in perfect conditions and in place, an that is clear of any fat as to prevent knob from accidentally coming lost. If the knob should fall into the cylinder during production cycle, it would cause serious damage to the machine.

Note: Gaskets must be periodically replaced.

- Firmly tighten beater's fixing knob [7];
- put lid [5] in place, insert pin [25];
- install the locking door [40] as illustrated in the drawing, taking care not to damage it, not to touch its internal surface [X] in contact with the extraction pipe [45]; reinstall the flat springdriver [46] with the relative big spring [47] and the fixing knob [41] on the left side, the conic springdriver [48] with the relative small spring [49] and the fixing knob [41] on the right side;
- install the chute [9] beneath the extraction door [14], fixing it to the hinges [26];
- install the basin support [10] fixing it to the front panel through the knobs [16].

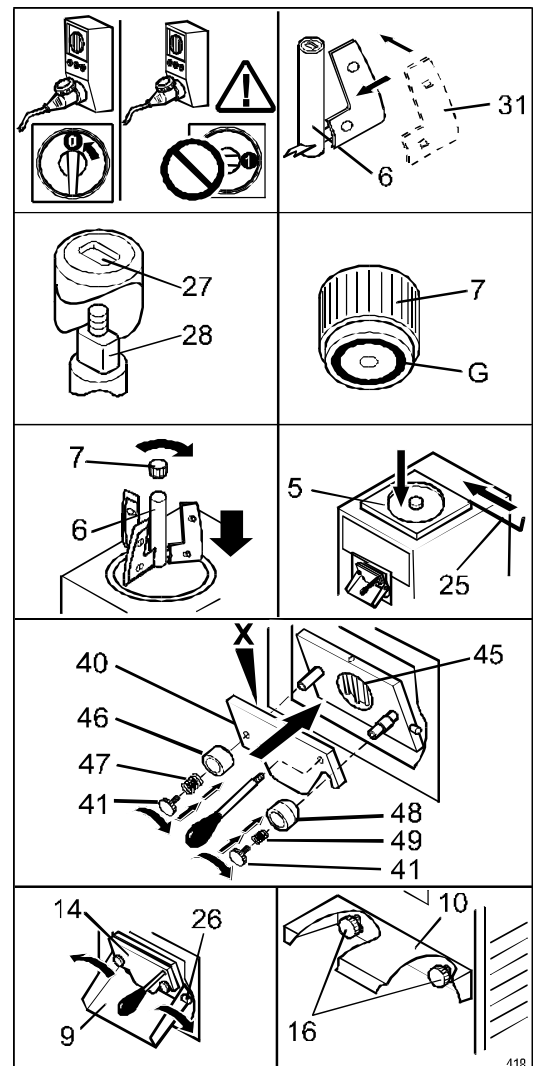

4 Sanitization

After reinstalling all the machine's components (as previously described), carry out a sanitization with water solution and disinfecting SANI- T- 10 manufactured by SPARTAN CHEMICAL. Follow accurately the next steps

STEP 1

Prepare a pail with a solution composed by 2 gal. of water and 1/2 oz. of disinfecting SANI- T- 10.

STEP 2

Check that the extraction door is closed, open lid, pour the detergent solution in the tank and close the lid again.

STEP 3

Press the beating pushbutton [K2], this will cause the sanitizing solution to be agitated in the tank.

STEP 4

5 minutes later, press the beating pushbutton [K2] again, place a pail beneath the extraction door and clear out the tank.

STEP 5

A potable water rinse is not necessary unless so specified by state or local ordinance.



After the sanitization, close the lid and do not touch with the hands anymore, nor dry with clothes or paper all parts in direct contact with food.

Note: Additionally to the operations mentioned in this Chapter, it is recommended to clean machine's outer panels and all of its outside parts.

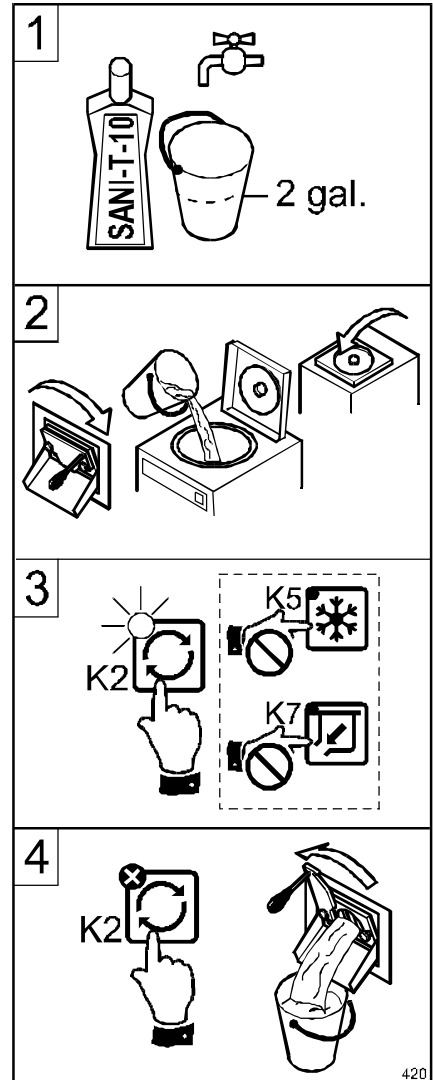

9 MAINTENANCE

The machine requires a very limited maintenance. Periodically, we suggest to:

- check the good conditions of the machine's parts;
- check that the electric power cable is not damaged;
- Try the efficiency of the safety devices (ref. Par. 8.2)

It is then useful to maintain the external panels clean and the surrounding area. Dust, paper fragments or other small objects may penetrate in the machine through the ventilation loopholes (in particular if equipped with air condensation and rapidly compromise its correct functioning.

The inside parts, to which the user **MUST NOT** accede, must be checked by the Assistance Service (ref. Par. 8.3)

9.1 Maintenance during the disassembling of the parts

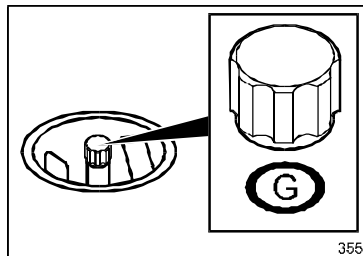

Check the integrity of gaskets (indicated with [G] in the figure) and substitute those that are deteriorated.

Use exclusively original, compatible with food, rubber gaskets. The spare bag contains a complete series of gaskets approved by the manufacturer.



To correctly replace the gaskets it is necessary to:

- remove the old gaskets by using a sharp tool, possibly non-metallic, paying attention not to scratch the seating of the gaskets themselves;
- clean the seatings and the gaskets from any kind of grease before inserting the new gaskets.

A yearly preventive replacement of all wearing parts and all gaskets is recommended. We suggest you to always keep a spare supply: to order it, make reference to the Spares Section contained in the Technical Handbook.

9.2 Checking of safety devices

Every three months, check that all safety devices on your machine are in perfect working order:

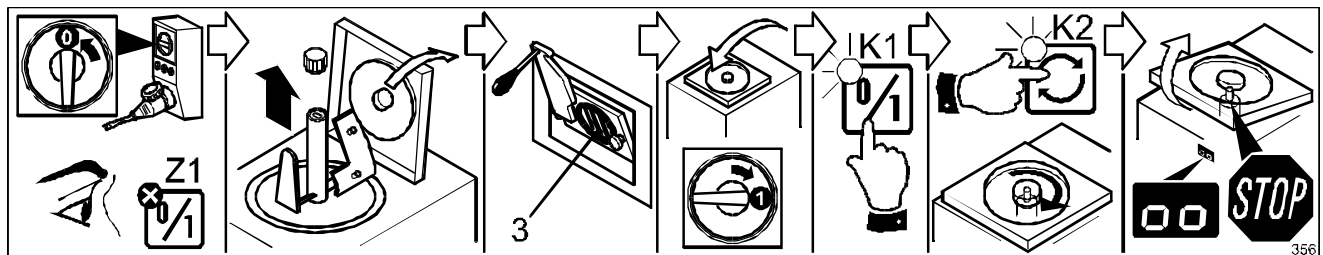

- open the lid and remove the beater;
- check that the protection grill [3] is well fixed and not damaged;
- close lid and supply the machine;
- turn beating on (beater's shaft will start). Then open the lid. Provided that the lid's magnetic contact is correctly working, the beater's shaft will stop immediately and the Display will show "oo" (two small squares).

If the machine's functioning is as described, the safety devices are efficient.



THE MACHINE MUST NOT BE USED IF ONE OR MORE OF THE SAFETY DEVICES SHOULD RESULT DAMAGED OR MALFUNCTIONING!

9.3 Yearly maintenance

Periodically (basing yourself on the environmental conditions in which the machine operates) and in any case once every year, make sure to have a general check-up.



THE CHECK-UP MUST BE MADE BY THE AUTHORISED ASSISTANCE SERVICE, OR, IN ANY CASE, BY TECHNICALLY AUTHORISED PERSONNEL WITH SUITABLE TOOL. THE MAINTENANCE OPERATIONS RESERVED TO THE SERVICE ASSISTANCE CAN BE DANGEROUS IF CARRIED OUT BY NON-PROFESSIONALS, THEREFORE, FOR HIS OWN SAFETY, THE USER MUST NEVER CARRY THEM OUT.

10 PERIODS OF INACTIVITY

If long periods of inactivity are foreseen, proceed as follows:

- wash up completely the device (see Section 7);
- switch off the power breaker and unplug the device;
- devices with WATER condensation: close the water faucet and relieve pressure from inside the delivery pipe by unscrewing one of the pipe fittings. Remove both delivery and drain pipes and let all water out. Before using the pipes again, following a long period of inactivity, check for any damages or cracks and replace, if necessary, pipe fittings' gaskets.
- if the device will be stored in a different place, group all the documentation, together with the present manual, and enclose it at the device (i. e. in the cylinder).



Before storing the device (with WATER condensation) in rooms with a temperature lower than 0°C it is INDISPENSABLE to get rid of the water in the condensator and in the inlet and outlet pipes. Call the Assistance Service.

11 MALFUNCTIONS



WE RECOMMEND YOU TO CALL IMMEDIATELY THE ASSISTANCE SERVICE IF A MALFUNCTION DIFFERENT FROM THOSE HERE DESCRIBED IS FOUND.

Note: the following malfunctions do not refer to problems noticed in the installation phase, but ONLY on correctly installed - and already functioning - devices.

THE DEVICE DOES NOT WORK OR STOPS WORKING.

With the Main Breaker on 1, the ON/OFF indicator light [Z1] DOES NOT TURN ON.

Cause: The plug is not correctly plugged.

The plug is defective. A qualified technician should substitute it.

Power in the socket is missing. Check that the breakers, the omnipolar switches and the differentials (lifesavers) on the electric system are closed. If they aren't, before closing them, make sure that no one is making electric maintenance.

A protective fuse of the electric system is cut down. Find and eliminate the eventual cause of overcharge. Substitute cut down fuses with others of the same kind.

The supply cable is defective. BEFORE, cut down electrical feeding at the socket by opening the breaker above it, then disconnect the plug and call the Assistance Service.



DO NOT TOUCH THE DAMAGED ELECTRIC CABLES BEFORE HAVING CUT DOWN THE ELECTRIC SUPPLY!

With the Main Breaker on 1, the ON/OFF indicator light [Z1] TURNS ON, but the display shows 2 small squares and the device does not work.

Cause: The lid is not correctly closed or tends to open;

The product lifts the lid due to an excessive quantity or an excessive volume increasing. Use a smaller amount of mixture or more suitable ingredients.

The lid's magnet is damaged. Call the Assistance Service.

Cause: The chute with protection flap is not correctly in place.

The magnet or the chute's magnetic contact is damaged. Please call Assistance Service.



THE MAGNETS AND THEIR CONTACTS ARE IMPORTANT SAFETY DEVICES!

Cause: The refrigerator's safety pressure switch comes on. Check the machine's air/condensing water supply. See also par. Malfunctions: *"The refrigeration is insufficient..."*

The compressor's back up relay switches off, following excessive stress (repeated starts high pressure, overheating). Stop the device, wait a few minutes and start again. If the inconvenient shall repeat or frequently repeat, call the assistance service.

The Beater's back up relay switches off, following overuse or mechanical overload. Check that the eventual product in the cylinder is not excessively dense and that there are no other causes of mechanical stress. Stop the device, wait a few minutes and try again. If the inconvenient should not be eliminated, or should frequently repeat, call the assistance service.

Note: it may be necessary to wait up to 30 minutes for the thermal protections to cool down.

With the Main Breaker on 1, the ON/OFF indicator light [Z1] TURNS ON, but the device does not work.

Cause: Break down of inside parts or the electronic controls. Call the Assistance Service.

THE DEVICE CAUSES REPEATED RELEASES OF THE MAIN ELECTRIC PROTECTIONS OR THE INTERRUPTION OF MAIN FUSES.

Cause: The capacity of the electric system is not sufficient to feed the device.

The electric characteristics of protections and fuses are not adequate.

Inside breakdown of the device. Call the assistance service.

THE REFRIGERATION IS INSUFFICIENT OR DISACTIVATES IN AN ANOMALOUS WAY.

AIR CONDENSING devices

Cause: Obstacles are placed at the air conditioning's opening, at a distance lower than that described. Restore the minimal distance reported in the Technical Handbook.

The room temperature is too high and condensation is inadequate.

The air condenser is dirty. Request the cleaning at the Assistance Service.

The condenser's fan is broken. Call the Assistance Service.

Break down of the refrigerating system or the electric controls. Call the Assistance Service.

WATER CONDENSING devices:



Cause: The flow of condensing water is interrupted or insufficient.

The water tubes present constrictions. Avoid constrictions.

The water condensing faucet/s are partially or totally closed.

The static pressure valve must be newly regulated, otherwise it is broken. Call the Assistance Service.

Note: To check if the water correctly flows and if the static pressure valve is regulated, it is sufficient to temporarily detach the water outlet tube (at the end not connected at the device). Water must flow only when the refrigerating system is in function.

The incoming water's temperature is higher than that prescribed in the Technical Handbook.

Cause: The compressor is overheated due to a lack of ventilation. Clean the loopholes and restore the minimal distances for the circulation of air at the sides of the device.

Note: it may be necessary to wait up to 30 minutes for the thermal protections to cool down.

Break down the refrigerating system, or the electric controls. Call the Assistance Service.

Unusual noises.

The noisiness comes, mainly, from the cylinder, when the beating is activated.

Cause: Beater's blades are not correctly adjusted. Proceed as describes in Par. 7.5 - Adjusting blades.

A layer of ice has developed between the beater and the cylinder: the mixture is not idoneous, or is not sufficient.

Beater's blades may be damaged or worn. Check that the plastic blades' scraping edges do not show any dents, scratches or wear marks which cannot be mended by adjusting. Should this be the case, replace blades.

The beater and/or the cylinder are damaged or excessively worn. Call the Assistance Service.

Cause: The beater and/or the cylinder have gone through a sudden temperature's changing, and stress mechanically. Stop the machine and wait for a few minutes.

The noisiness DOES NOT come from the cylinder, or it there is also when the beating is not activated.

Cause: Inside break down. Call the Assistance Service.



**WARRANTY
CUSTARD EQUIPMENT AND BATCH EQUIPMENT**

1. **Scope:**
PW Stoelting, L.L.C. (“Stoelting”) warrants to the first user (the “Buyer”) that the freezing cylinders, hoppers, compressors, drive motors, speed reducers, beaters, and auger shafts of Stoelting custard equipment and batch equipment will be free from defects in materials and workmanship under normal use and proper maintenance appearing within two (2) years, and that all other components of such equipment manufactured by Stoelting will be free from defects in material and workmanship under normal use and proper maintenance appearing within twelve (12) months after the date that such equipment is originally installed.

2. **Disclaimer of Other Warranties:**

THIS WARRANTY IS EXCLUSIVE; AND STOELTING HEREBY DISCLAIMS ANY IMPLIED WARRANTY OF MERCHANTABILITY OR FITNESS FOR PARTICULAR PURPOSE.

3. **Remedies:**
Stoelting’s sole obligations, and Buyer’s sole remedies, for any breach of this warranty shall be the repair or (at Stoelting’s option) replacement of the affected component at Stoelting’s plant in Kiel, Wisconsin, or (again, at Stoelting’s option) refund of the purchase price of the affected equipment, and, during the first twelve (12) months of the warranty period, deinstallation/reinstallation of the affected component from/into the equipment. Those obligations/remedies are subject to the conditions that Buyer (a) signs and returns to Stoelting, upon installation, the Start-Up and Training Checklist for the affected equipment, (b) gives Stoelting prompt written notice of any claimed breach of warranty within the applicable warranty period, and (c) delivers the affected equipment to Stoelting or its designated service location, in its original packaging/crating, also within that period. Buyer shall bear the cost and risk of shipping to and from Stoelting’s plant or designated service location.

4. **Exclusions and Limitations:**
This warranty does not extend to parts, sometimes called “wear parts”, which are generally expected to deteriorate and to require replacement as equipment is used, including as examples but not intended to be limited to o-rings, auger seals, auger support bushings, and drive belts. All such parts are sold

AS IS.

Further, Stoelting shall not be responsible to provide any remedy under this warranty with respect to any component that fails by reason of negligence, abnormal use, misuse or abuse, use with parts or equipment not manufactured or supplied by Stoelting, or damage in transit.

THE REMEDIES SET FORTH IN THIS WARRANTY SHALL BE THE SOLE LIABILITY STOELTING AND THE EXCLUSIVE REMEDY OF BUYER WITH RESPECT TO EQUIPMENT SUPPLIED BY STOELTING; AND IN NO EVENT SHALL STOELTING BE LIABLE FOR ANY INCIDENTAL OR CONSEQUENTIAL DAMAGES, WHETHER FOR BREACH OF WARRANTY OR OTHER CONTRACT BREACH, NEGLIGENCE OR OTHER TORT, OR ON ANY STRICT LIABILITY THEORY.

COSTRUTTORE
CONSTRUCTEUR:
CONSTRUCTOR



MANUFACTURER:
HERSTELLER:
FABRIKANT:

Via S. Pertini, 10 - 26845 CODOGNO (LODI) ITALIA
Tel. 0377.466650 - Fax 0377.466690
Internet: www.telme.it
E-mail: telme@telme.it

Servizio Assistenza:
Service d'Assistance:
Servicio Asistencia:

Technical Service:
Kundendienst:
Servicedienst: