

ASSEMBLY AND INSTALLATION INSTRUCTIONS

W0475 / W0476

WARNING: TO AVOID RISK OF ELECTRICAL SHOCK, BE SURE TO SHUT OFF POWER WHILE INSTALLING OR SERVICING THIS FIXTURE.

NOTES: 1. Before installing, consult local electrical codes for wiring and grounding requirements.
2. Read and save these instructions.

Hardware Package (included):

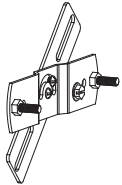

Crossbar Unit (A)

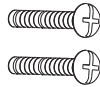

Mounting Screw (B)

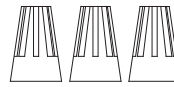

Wire Connector (C)



Bolt Nut (D)

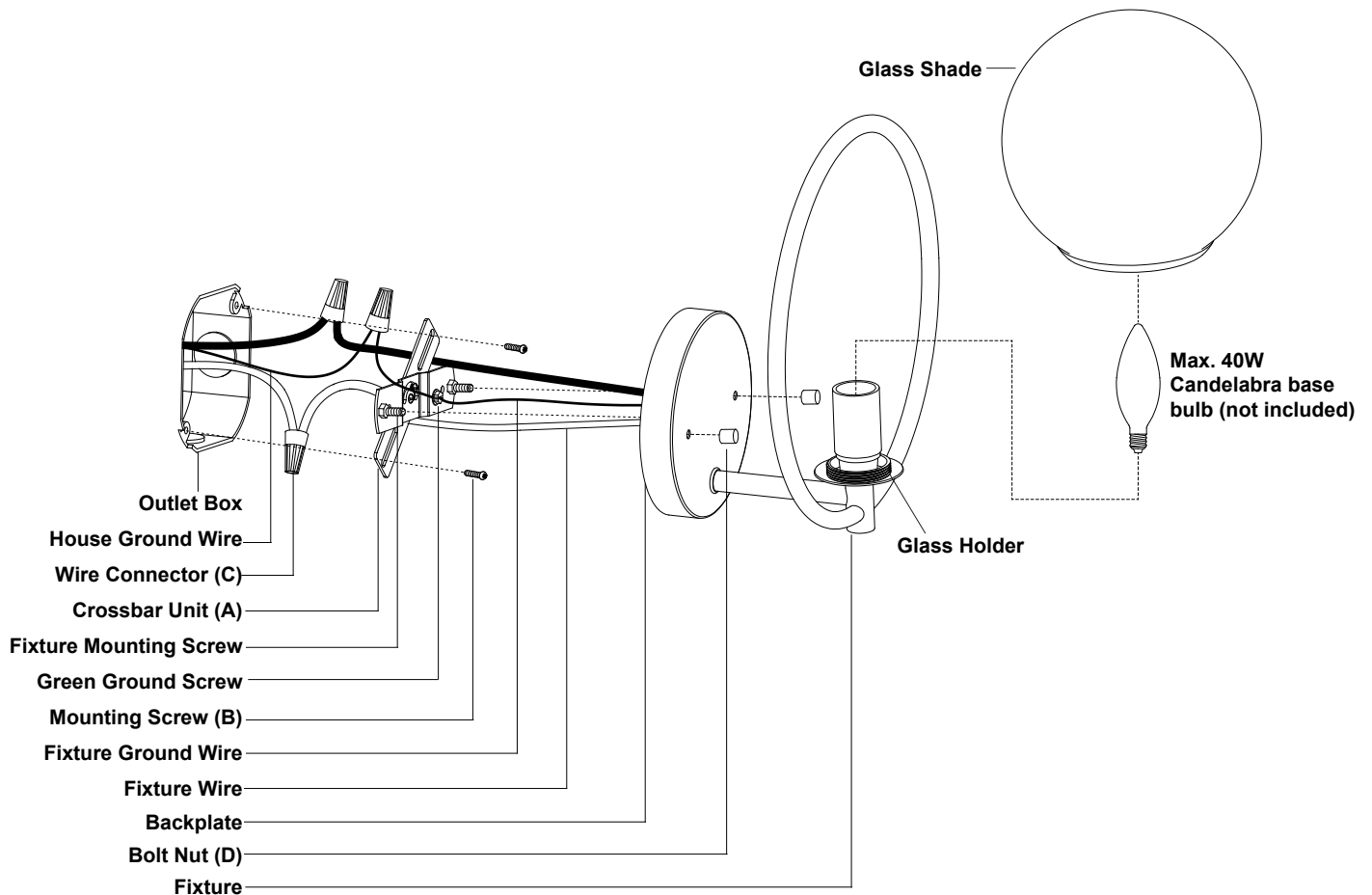

Installation Steps

Turn off the power at fuse or circuit box

1. Unscrew the two bolt nuts (D), remove the crossbar unit (A) from the backplate.
2. Attach the crossbar unit (A) to the outlet box using two mounting screws (B). Adjust the length of the preinstalled fixture mounting screws if necessary.



Note: Make sure that the fixture mounting screws are lined up horizontally to make the fixture level.

3. Pull out the wires and ground wire from the outlet box. Make wire connections using the wire connectors (C) as follows:
 - Connect the hot wire (black insulation) from the fixture to the black wire from the power source.
 - Connect the neutral wire (white insulation) from the fixture to the white wire from the power source.
 - Attach the fixture ground wire (bare wire) to the crossbar unit (A) with the green ground screw, then connect it to the house ground wire with the wire connector (C).
 Carefully put the wires back into the outlet box.
4. Attach the backplate to the crossbar unit (A) by aligning and inserting the two fixture mounting screws from the crossbar unit (A) into the open holes on the backplate, then screw it with the two bolt nuts (D).
5. Install 1 x 40W max. candelabra base bulb (not included). See relamping label at socket area or packaging for maximum wattage allowed.
7. Rotate the glass shade onto the glass holder until it is locked in place. (Do not over tighten the glass shade).
8. This fixture can be mounted with light pointed up or down.

Turn on the power at fuse or circuit box

The following parts are available for reorder if damaged or missing.

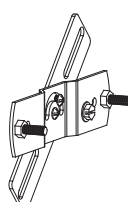
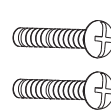
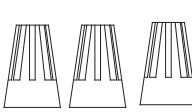
Spare Parts List:

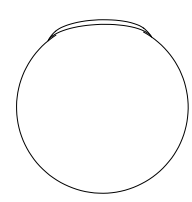
				<p>Assembly Kit 6851MM (1 SET) for W0475 6852MM (1 SET) for W0476</p>	
Crossbar Unit (A)	Mounting Screw (B)	Wire Connector (C)	Bolt Nut (D)		

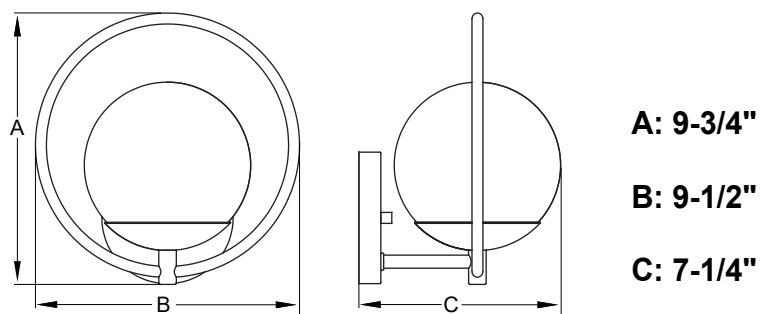

1 Year Warranty

Vaxcel warrants all of our products against defects in workmanship and finishes for one year following the date of shipment.

Exclusions: This warranty does not include the failure of products from extreme acts of nature; environmental conditions not suited for the products intended use; operation in temperatures outside of the range specified in the instruction manual; usage with improper power supply, power surges or dips. For coastal locations, some corrosion is considered normal for the environment.

Vaxcel reserves the right to repair, replace or issue a credit for any properly installed product, provided it is returned per RMA instruction. This warranty is limited to the cost of the product only and does not extend to transportation, installation or replacement costs.

How can warranty service be obtained?
 info@vaxcel.com
 1-800-482-9235