

INSTRUCTION MANUAL

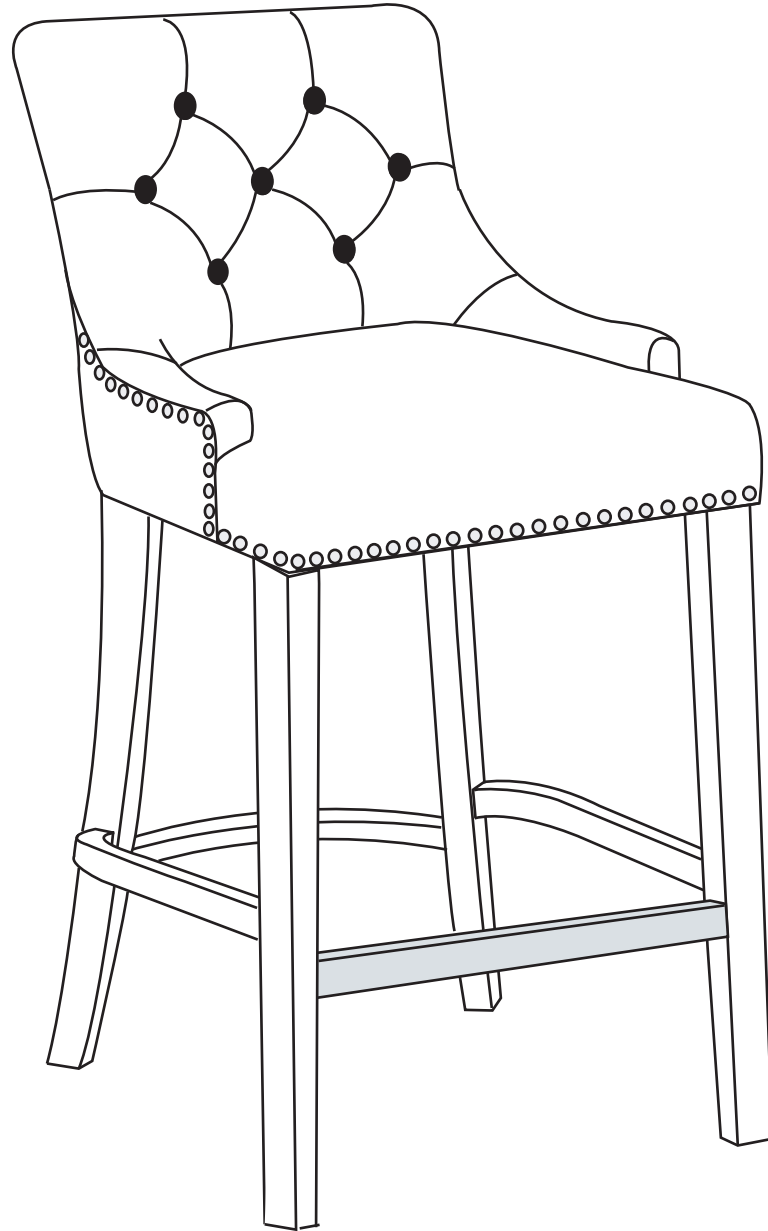

29" Linen Fabric Tufted Upholstered Counter Stool
SKU: ID404-29

! CARE & MAINTENANCE

- Be careful when assembly, avoid hurting the paint .
- Clean the dust with lukewarm water, mild detergent & soft cloth.
- Firmly secure all bolts before use, do not use any part of this item as a step ladder.
- Reconfirm that all bolts, screws, and nuts are secure every 90 days.
- Do not use or store this item in the proximity of open flame or flammable/combustible chemicals.

TOOLS REQUIRED



ALLEN WRENCH
(PROVIDED)



SCREW DRIVER
(NOT PROVIDED)



300 LBS
CAPACITY



2 PERSONS
ASSEMBLY



UP TO 20 MIN.
ASSEMBLY

HARDWARE

1

Flat washer



Φ8
8PCS

2

Lock washer



Φ8
8PCS

3

Allen Key



M8
1PC

4

Shorter
Screw



M8x55MM
4PCS

5

Longer
Screws



M8x65MM
4PCS

6

Self-tapping
Screws



M4x45MM
8PCS

PARTS

A

Back

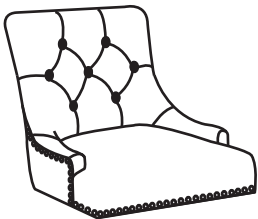

1PC

B

Front leg -Left



With Adjustable
Feet Leveler

1PC

C

Front leg - Right



With Adjustable
Feet Leveler

1PC

D

Hind Leg - Left

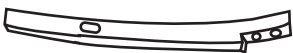

With Adjustable
Feet Leveler

1PC

E

Hind Leg - Right

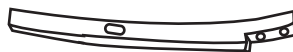

With Adjustable
Feet Leveler

1PC

F

Side Footrest -Left



1PC

G

Side Footrest - Right



1PC

H

Front Footrest



1PC

I

Hind Footrest



1PC

J

Front Metal Footrest



1PC

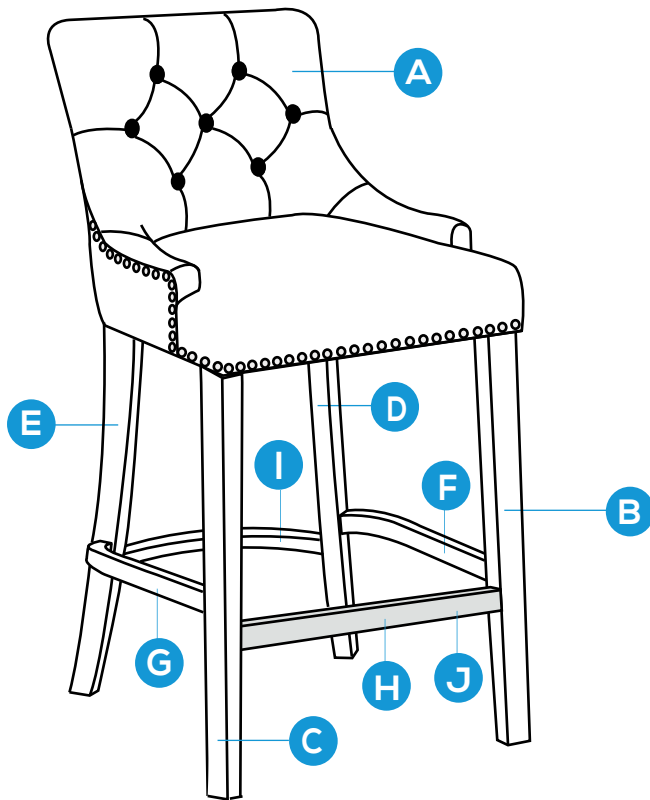

PRODUCT ASSEMBLY

1

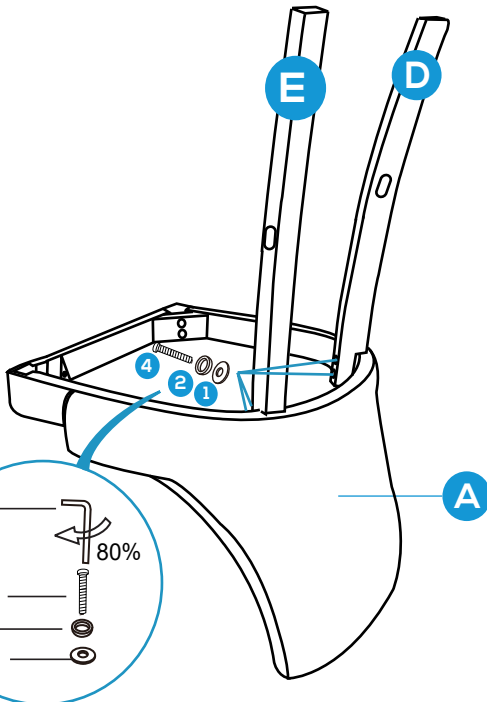

Put chair back on a clean flat surface.
Align Hind legs in the seat pad as shown in the diagram.

Using SHORTER SCREW (4) with Washer (#2, 1).

DO NOT FULLY TIGHTEN.

First **HAND** tighten then tightened using key up-to 60-80% only at this stage.

PRODUCT ASSEMBLY

2

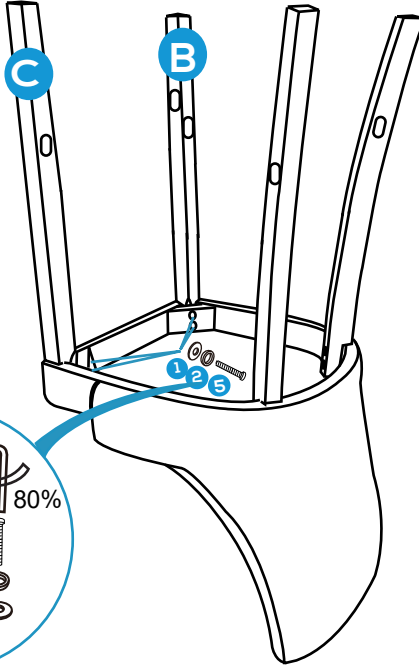

Align front legs in the seat pad as shown in the diagram.
Using **LONGER SCREW (5)** with **Washer (#2, 1)**.

DO NOT FULLY TIGHTEN.
First **HAND** tighten then tightened using key up-to **60-80%** only at this stage.

3

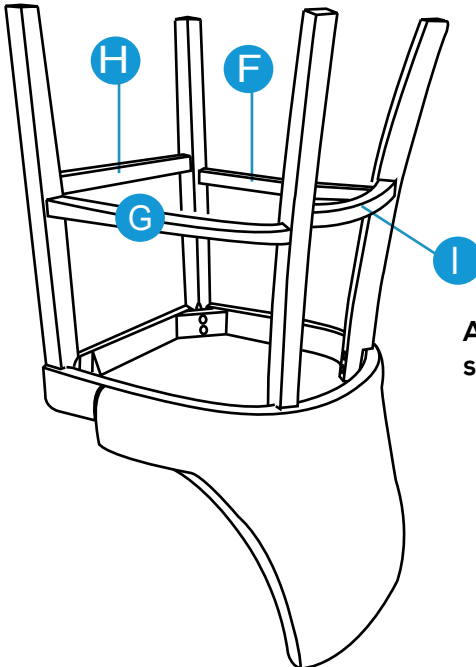

Align all footrest in the legs as shown in the diagram.

PRODUCT ASSEMBLY

4

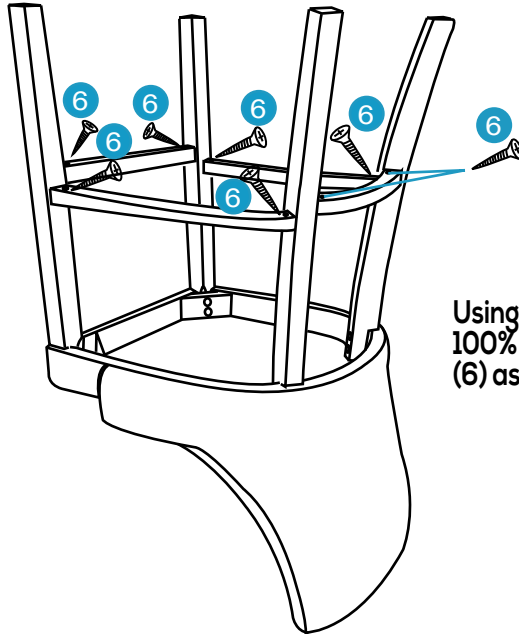

Using your own screwdriver
100% lock Self-tapping Screw
(6) as shown in the diagram

5

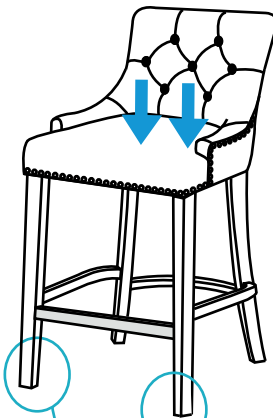
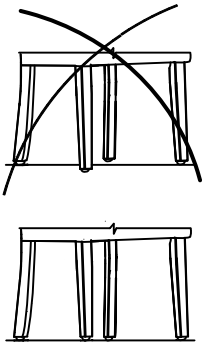

Put chair in the upright position and
SIT ON THE CHAIR to press downwards on
the seat pad.

Ensuring that all 4 feet touch the ground
and chair is leveled.

Proceed to tighten all screws making sure
the chair remains level when tightening.

Check that all screws are tight on a
regular basis to ensure chair remains level
and secure.

Also you can using adjustable feet to keep
four legs level .

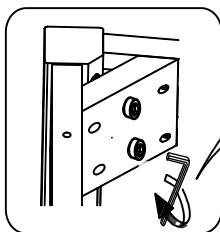

100%

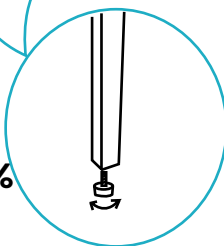

With Adjustable Feet Leveler

PRODUCT ASSEMBLY

6

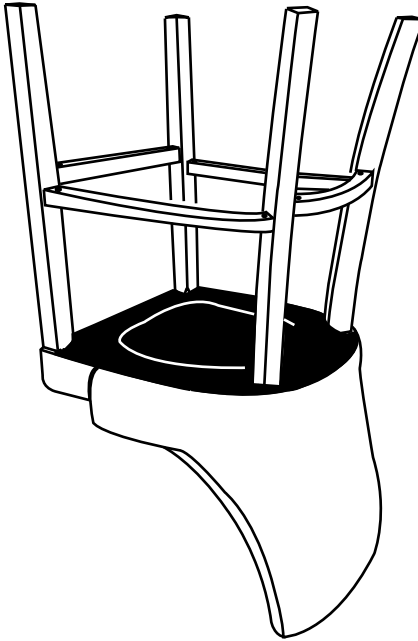

Then close the black fabric cover

7

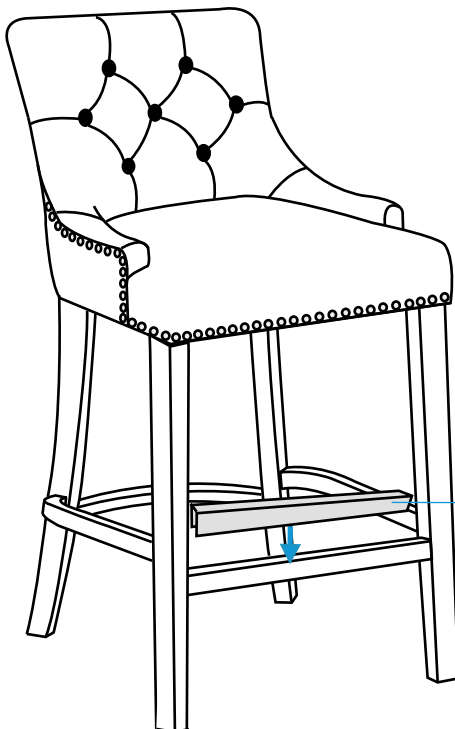

It is an option to add Parts J Front Metal Footrest on Parts H Front Footrest, to prevent from paint scratching when stepping on.

GENTLY PUT IT ON AND DO NOT TAKE OFF FREQUENTLY IN CASE HURT THE PAINT.

J