

SIDES	BOTTOM
4 PCS #1/4-28×3/8 Screws Installed	
Material:Steel-Welding tube, zinc plated	

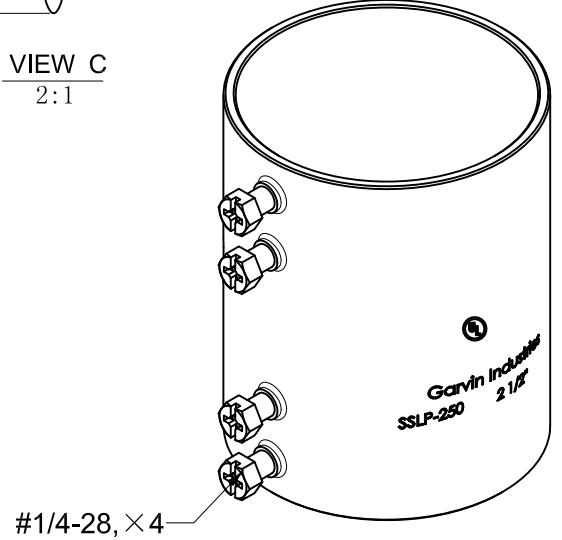
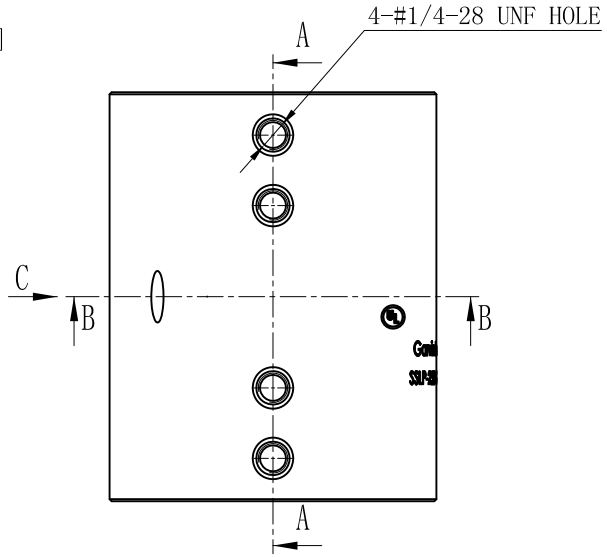
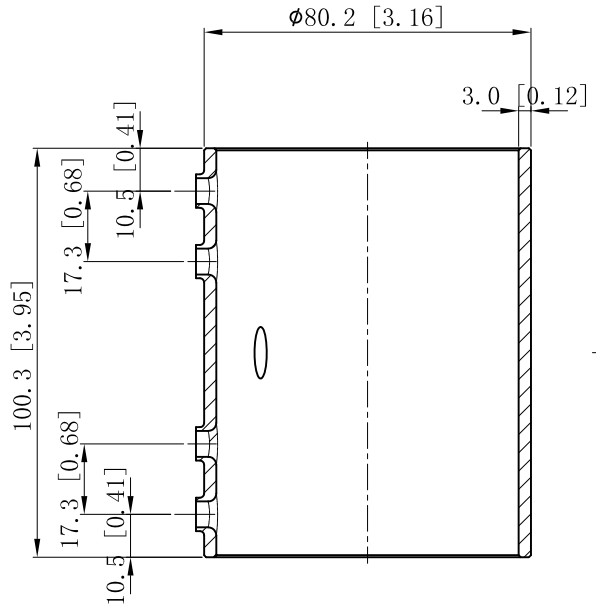
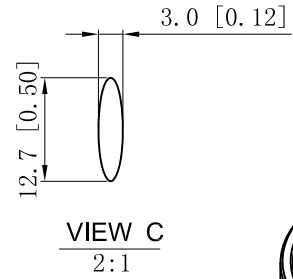
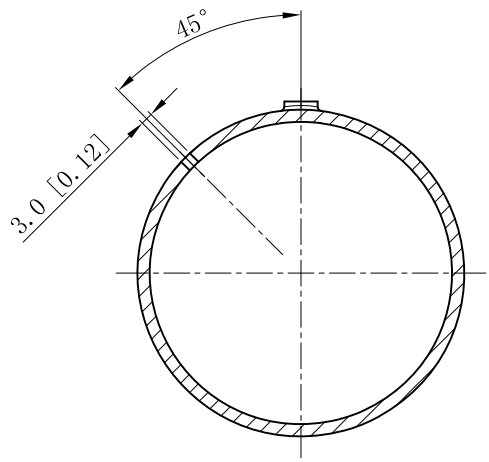

This data sheet is for reference only .GARVIN INDUSTRIES reserves the right to make changes to the design without prior notice.

DESCRIPTION
TRADE REFERENCE TERMS

STANDARD PACKING	GARVIN INDUSTRIES		
	TITLE STEEL EMT SET SCREW COUPLINGS		
	SIZE A4	DWG NO. SSLP-250	REV C
	DATA SHEET		
www.garvinindustries.com			