

8-Hole 4.5" x 4.5", Square Corner Door Hinge 12-Pack
Antique Brass

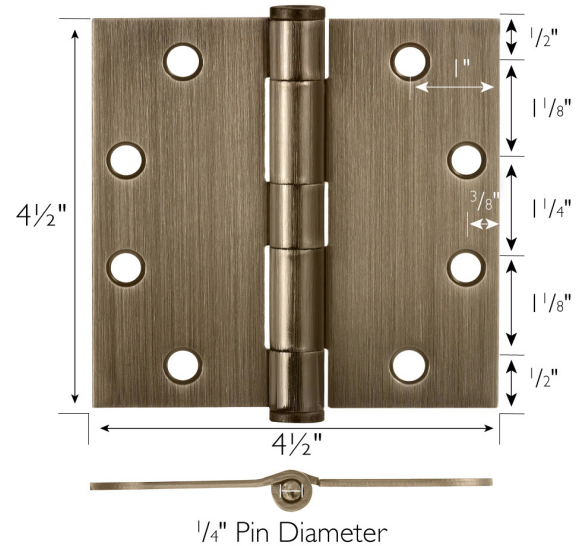

SPECIFICATIONS

MATERIAL CONSTRUCTION:	Steel
MOUNTING HARDWARE INCLUDED:	#12 x 1 1/4" screws x 8
TOOLS NEEDED FOR INSTALLATION:	Screwdriver
ASSEMBLED DIMENSIONS:	4.5" H x 4.5" L x 0.13" W
ASSEMBLED WEIGHT:	13.23 lbs
CORNER RADIUS:	Square Corner
HINGE TYPE:	Butt Hinge

WARRANTY: 1-Year limited warranty

LEGAL FOR SALE IN CALIFORNIA: Yes



TYPE:
JOB:
ORDER CODE:
APPROVALS: