

OVERVIEW

The rCMS family of nLight AIR-enabled wireless ceiling/surface mount occupancy sensors provide a range of sensor solutions for applications with finished ceilings (e.g. ceiling tiles, sheetrock, plaster). The rCMS family sensors utilize digital Passive Infrared (PIR) detection and are available with several lens options, providing flexibility for multiple mounting height and coverage pattern requirements. Dual technology occupancy detection can also be added as an option for applications where occupants are stationary for long periods of time. All sensors have integrated on/off photocells, with automatic daylight harvesting/dimming control standard. Additionally, the rCMS family sensors are also available with an optional auxiliary low voltage relay for simple integration with a BMS system or other building system.

The rCMS family sensors are powered by an nLight AIR Power Pack (rPP20) or by a 24V DC supply (PS150). rCMS family sensors typically communicate with one or more nLight AIR-enabled fixtures or Power Packs to enable control of fixtures individually or in groups.

FEATURES

- Digital PIR detection
- Integrated, dimming photocell standard – Photocell views down through sensor lens
 - Provides automatic dimming control between min and max trim levels
 - Works during occupied periods when applied with an occupancy behavior
- Optional auxiliary low voltage solid-state relay (AR option) for dry contact output
- LED status indicator
- Adjustable settings (e.g. occupancy time delays, photocell set-points) via **CLAIRITY™**+ mobile app or SensorView software application
- Powered by 24V DC from rPP20 or nLight PS 150 power supply
- Standards-based nLight AIR 900 MHz

Warranty

Five-year limited warranty. This is the only warranty provided and no other statements in this specification sheet create any warranty of any kind. All other express and implied warranties are disclaimed. Complete warranty terms located at: www.acuitybrands.com/support/warranty/terms-and-conditions

Note: Actual performance may differ as a result of end-user environment and application. Specifications subject to change without notice.



Items marked by a shaded background qualify for the Design Select program and ship in 15 days or less. To learn more about Design Select, visit www.acuitybrands.com/designselect. *See ordering tree for details

nLight, nLight AIR and the Acuity Controls and Acuity Brands logos are trademarks of Acuity Brands. Bluetooth is a trademark of Bluetooth SIG, Inc. used by Acuity Brands under license. Apple and the Apple logo are trademarks of Apple Inc. Android and Google Play are trademarks of Google, Inc. Other trademarks are property of their respective owners.



nLight® AIR rCMS Ceiling Mounted Smart Sensor



RCMS 9



RCMS 10



RCMS 6



Design Select options indicated by this color background.

ORDERING INFORMATION

rCMS		Example: RCMS PDT 10 AR G2					
Series / Detection	Power Supply ¹	Occupancy Detection	Lens (Required)	Operating Mode	Generation		
RCMS nLight AIR occupancy and daylight sensor	[blank] Power Supply ordered separately PS 150 Standard 150 mA Power Supply	[blank] PIR Detection PDT ² Dual Tech PIR/Microphonics	10 Large Motion/ Extended Range 360° 9 Small Motion/ Extended Range 360° 6 High Bay 360° Lens	[blank] None AR Auxiliary Relay	G2 Generation 2 compatibility		

1. PS 150 or RPP20 24V required to power RCMS. Can also be ordered separately.
2. Must be ordered with 10 or 9.

SPECIFICATIONS

Dimensions	4.55" Dia. (11.56 cm) 1.55" Deep (3.94 cm)
Product Weight	6 oz
Color	Matte White
Enclosure Material	Poly-Carbonate/ABS
Max Humidity	5-95% non-condensing
Mounting	Ceiling Tile / Sheetrock Surface, 3.5" Octagon Box, Single Gang Handy box
Wires	9"; (2) 20 AWG used for DC input; 9"; (2) 20AWG used for AR option only
Relay Rating (AR option only)	100mA @ 24VAC/VDC (resistive only)
Input Voltage Range	6V to 50V
Peak Consumption	650mW
Operating Temperature	-40°C to 85°C
Storage Temperature	-40°C to 85°C
Radio Frequency	Dual Radio: 900MHz & 2.4GHz
RF Transmit Power	900MHz: up to 20 dBm 2.4GHz: up to 10.4 dBm
Wireless Standard	900MHz: IEEE 802.15.4-based 2.4GHz: Version 4.0+ of the Bluetooth specification
Wireless Range	900MHz: Up to 1000 ft. (~304m) in free space/ line of sight Minimum of 150 ft through typical construction 2.4GHz: Up to 60 ft. (~18m) in free space/ line of sight
Security Application Data Encryption:	AES-128 bit
	Mutual Entity Authentication
	Message Confidentiality
	Message Authentication and Replay Prevention
	Limited Anonymity
	Complies with California Civil Code Title 1.81.26, Security of Connected Devices, approved under Senate Bill No. 327 (2018)
Regulatory Compliance Wireless:	FCC ID: 2ADCB-RMODIT3, cULus, ROHS Compliant
	IC: 6715C-RMODIT3
	IFETEL: RCPNLNL20-2057

COVERAGE PATTERNS

Recommended mounting 4' or more away from HVAC vents.

SMALL MOTION 360°



- Best choice for small motion (e.g. hand movements) detection
- 360° conical shaped pattern
- Provides 12 ft (3.66 m) radial coverage (~500 ft²) when mounted to standard 9 ft (2.74 m) ceiling
- 8 to 15 ft (2.44 to 4.57 m) mounting heights provide 10 to 20 ft (3.05 to 6.10 m) radial coverage

SIDE VIEW

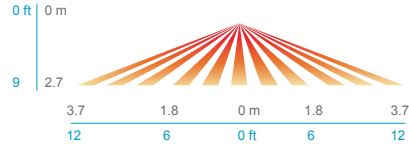

TOP VIEW

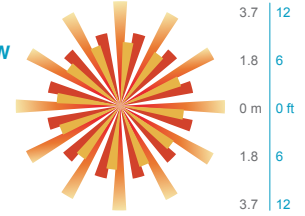

¹ Sensors with Microphonics™ provides overlapping detection of human activity over the complete PIR coverage area. Advanced filtering is also utilized to prevent non-occupant noises from keeping the lights on.

LARGE MOTION 360°



- Best choice for large motion detection (e.g. walking)
- 360° conical shaped pattern
- Provides ~24 ft (7.32 m) radial coverage (~2000 ft²) when mounted at 9 ft (2.74 m)
- 7 to 15 ft (2.13 to 4.57 m) mounting heights provide 16 to 36 ft (4.88 to 10.97 m) radial coverage
- Detection range improves when walking across beams compared to into beams

SIDE VIEW

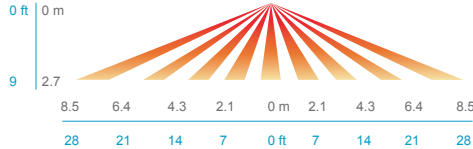

TOP VIEW

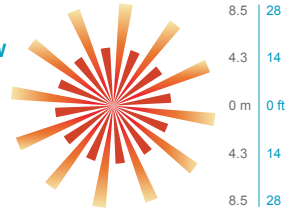

¹ Sensors with Microphonics™ provides overlapping detection of human activity over the complete PIR coverage area. Advanced filtering is also utilized to prevent non-occupant noises from keeping the lights on.

HIGH MOUNT 360°



- Best choice for 15 to 45 ft (4.57 to 13.72 m) mounting heights
- 15 to 20 ft (4.57 to 6.10 m) radial coverage overlaps area lit by a typical high bay fixture
- Excellent detection of large motion (e.g. walking) up to 35 ft (10.76 m)
- Excellent detection of extra large motion (e.g. forklifts) up to a 45 ft (13.72 m)

LOW VIEW

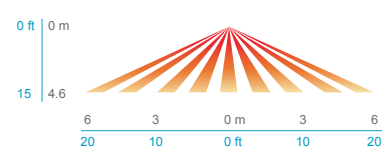

HIGH VIEW

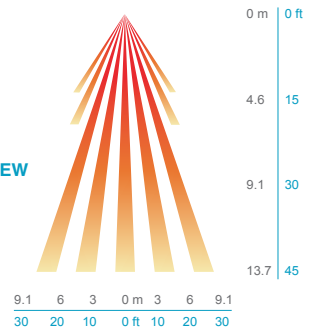

Wiring an rCMS to an nLight AIR relay Power Pack (rPP20)

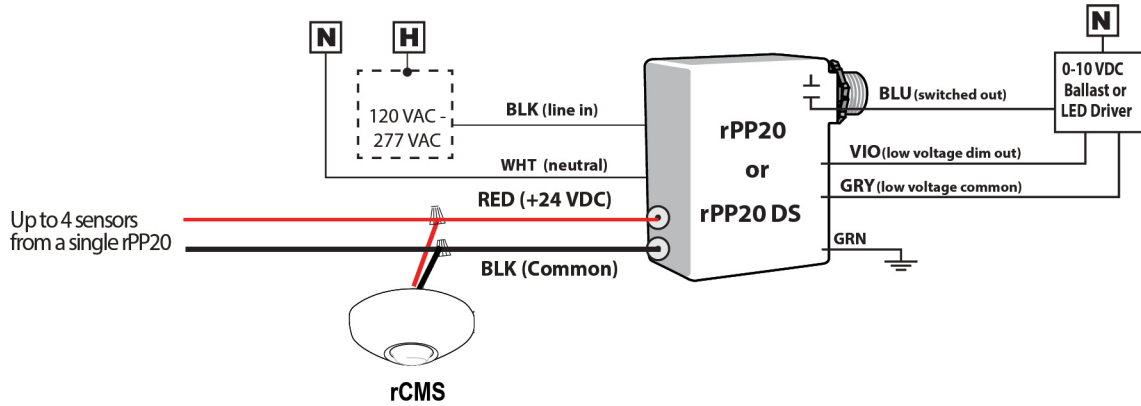

Wiring to an nLight PS 150 Power Supply

