



DENALI AIRE®

OWNER'S/INSTALLATION MANUAL

ROOM AIR CONDITIONER



MODEL 3DANC6K

REGISTRATION

To register your air conditioner, please visit
www.newleafsc.net/denaliaire
and click on "Register Your Product"

To find the model and serial number of your product,
please refer to the diagram below:

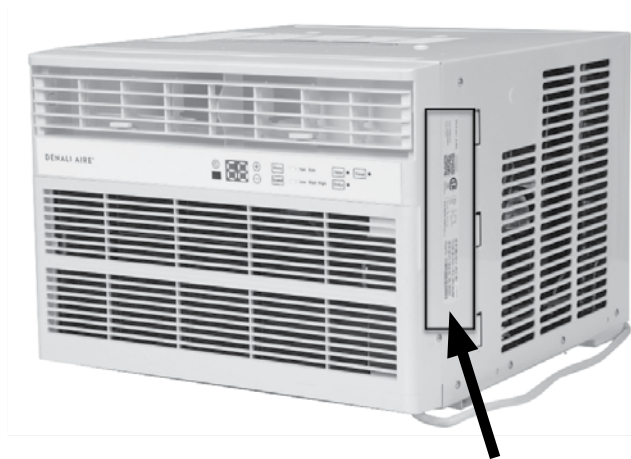

Sticker located on the side of the air conditioner.
Image is for reference only, your exact model may differ in appearance.



The model number identifies the specific version or type of your product, while the serial number is a unique identifier for your individual unit. These details about the product are essential for any warranty claims, registration, or technical support inquiries. Registration is not mandatory for warranty but strongly suggested as a means to contact you and receive important product updates.

CONTENTS

Safety Information.....	4
-------------------------	---

Using the Air Conditioner

Controls.....	6
Remote Control.....	6
Cool Mode	7
Energy Saver Mode.....	7
Air Direction	7

Care and Cleaning

Grille and Case	8
Air Filter.....	8
Outdoor Coils	8
Install Batteries in Remote.....	8

Installation Instructions

Before You Begin.....	9
Electrical Requirements.....	9
Parts Included	10
Window Requirements.....	11
Preparing the Air Conditioner.....	11
Installing the Air Conditioner	12

Troubleshooting

Troubleshooting Tips.....	13
Normal Operating Sounds.....	14

IMPORTANT NOTE:

Read the manual carefully. Make sure to save this manual for future reference. Illustrations in this manual are for explanatory purposes only, your actual product may look slightly different.

 **WARNING:** Cancer www.P65Warnings.ca.gov

SAFETY INFORMATION

IMPORTANT SAFETY INFORMATION | READ ALL INSTRUCTIONS BEFORE USING THE APPLIANCE

WARNING

For your safety, the information in this manual must be followed to minimize the risk of fire, electric shock or personal injury.

- Use this appliance only for its intended purpose as described in this Owner's Manual.
- This air conditioner must be properly installed in accordance with the Installation Instructions before it is used.
- Never unplug your air conditioner by pulling on the power cord. Always grip plug firmly and pull straight out from the receptacle.
- Replace immediately all electric service cords that have become frayed or otherwise damaged. A damaged power supply cord must be replaced with a new power supply cord obtained from the manufacturer and not repaired. Do not use a cord that shows cracks or abrasion damage along its length or at either the plug or connector end.
- Turn the unit OFF and unplug your air conditioner before cleaning.
- For your safety, do not store or use combustible materials, gasoline or other flammable vapors or liquids in the vicinity of this or any other appliance.
- If the receptacle does not match the plug, the receptacle must be changed out by a qualified electrician.

WARNING

Risk of Fire or Explosion. This unit contains flammable refrigerant. Additional safety precautions must be followed.

- Do not use means to accelerate the defrosting process or to clean, other than those recommended by the manufacturer.
- The appliance should NOT be stored in a room with continuously operating ignition sources (for example: open flames, an operating gas appliance or an operating electric heater).
- Do not pierce or burn refrigerant tubing. Be aware that refrigerants may not contain an odor.
- Keep ventilation openings clear of obstruction.
- When handling, installing, and operating the appliance, care should be taken to avoid damage to the refrigerant tubing.
- Do not drill holes in the unit.
- Maintenance, cleaning, and service should only be performed by technicians properly trained and qualified in the use of flammable refrigerants.
- We do not support any servicing of the air conditioner.
- Dispose of the air conditioner in accordance with Federal and Local Regulations. Flammable refrigerants require special disposal procedures. Contact your local authorities for the environmentally safe disposal of your air conditioner.

IMPORTANT SAFETY INFORMATION | READ ALL INSTRUCTIONS BEFORE USING THE APPLIANCE

WARNING

USE OF EXTENSION CORDS

RISK OF FIRE. Could cause serious injury or death.

- DO NOT use an extension cord with this Window Air Conditioner.
- DO NOT use surge protectors or multi-outlet adapters with this Window Air Conditioner.

HOW TO POWER

- Do not, under any circumstances, cut or remove the third (ground) prong from the power cord. For personal safety, this appliance must be properly grounded.
- **DO NOT** use an adapter plug with this appliance.
- The power cord of this appliance is equipped with a 3-prong (grounding) plug which mates with a standard 3-prong (grounding) wall outlet to minimize the possibility of electric shock hazard from this appliance.
- Power cord includes a current interrupter device. A test and reset button is provided on the plug case. The device should be tested on a periodic basis by first pressing the **TEST** button and then the **RESET** button while plugged into the outlet. If the **TEST** button does not trip or if the **RESET** button will not stay engaged, discontinue use of the air conditioner and contact a qualified service technician.
- Have the wall outlet and circuit checked by a qualified electrician to make sure the outlet is properly grounded.
- Where a 2-prong wall outlet is encountered, it is your personal responsibility and obligation to have it replaced with a properly grounded 3-prong wall outlet.
- The air conditioner should always be plugged into its own individual electrical outlet which has a voltage rating that matches the rating plate.
- This provides the best performance and prevents overloading house wiring circuits which could cause a fire hazard from overheated wires.
- See the Installation Instructions, **Electrical Requirements** section for **specific electrical connection requirements**.

WARNING

Chemical Burn Hazard. Keep batteries away from children.

- This product contains a dry battery. If a new or used dry battery battery is swallowed or enters the body, it can cause severe internal burns and can lead to death in as little as 2 hours. Always completely secure the battery compartment. If the battery compartment does not close securely, stop using the product, remove the batteries, and keep it away from children.
- If you think batteries might have been swallowed or placed inside any part of the body, seek immediate medical attention.
- The batteries shall be disposed of properly, including keeping them away from children.
- Even used batteries may cause injury.

USING THE AIR CONDITIONER

AIR CONDITIONER CONTROLS

Features and appearance may vary.

Lights below the touch pads on the air conditioner control panel indicate the selected settings.

1 Power Pad

- Turns air conditioner on and off. When turned on, the display will show the set temperature.

2 Display

- Shows the set temperature at all times in Cool or ECO modes or time remaining on the Delay timer.

3 Temp and Delay Increase + /Decrease – Pads

- Use to set temperature or delay time. Temperature can be set in Cool and ECO mode.

4 Mode Pad

- Use to set the air conditioner to **Fan Only**, **Cool**, or **ECO** mode.

5 Fan Speed Pad

- In **Cool**, **ECO** mode:
Use to set the fan speed to **Auto**, **High**, **Med** or **Low** on the unit.
- In **Fan Only** mode:
Use to set the fan speed to **High**, **Med**, or **Low** on the unit.

6 Delay Pad

- **Delay ON**—When the air conditioner is off, it can be set to automatically come on in 1 to 24 hours at its previous mode and fan settings.
- **Delay OFF**—When the air conditioner is on, it can be set to automatically turn off in 1 to 24 hours.

How to set:

Press the **Delay 1–24hr** pad on the unit or the remote control. Each touch of the **Increase + / Decrease –** pads on the unit or the remote control will set the timer in 1-hour intervals.

To review the remaining time on the **Delay 1-24hr** timer, press the **Delay 1-24hr** pad on the unit or the remote control. Use the **Increase + / Decrease –** pads on the unit or on the remote control to set a new time if desired.

To cancel the timer, press **Decrease –** pad on the unit or the remote control until the set time is zero. After 3 seconds the light on the **Delay 1-24hr** pad goes off.

7 Filter Reset Pad

- This feature automatically notifies you that the air filter must be cleaned. The indicator light will come on after 250 hours of operation. Clean the air filter (refer to page 8), place it back in the front panel, and press the Filter Reset pad. The light will go off.

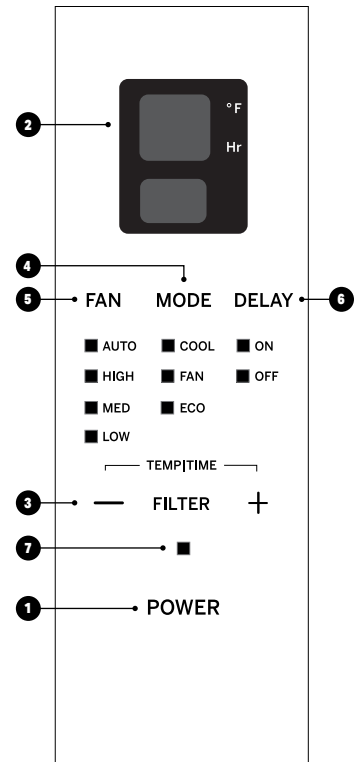

AIR CONDITIONER CONTROLS

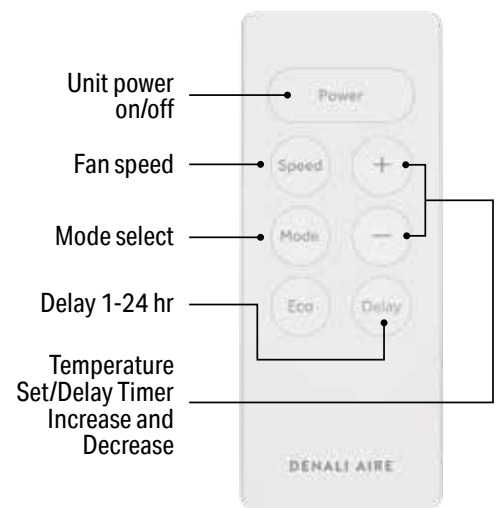

REMOTE CONTROL

AIR CONDITIONER CONTROLS

COOL MODE

Use the Cool mode at **Low, Med, High** or **Speed** for cooling. Use the **Temperature Increase + / Decrease –** pads to set the desired temperature between 64°F and 86°F in 1°F increments.

An electronic thermostat is used to maintain the room temperature. The compressor will cycle on and off to keep the room at the set level of comfort. Set the thermostat at a lower number and the indoor air will become cooler. Set the thermostat at a higher number and the indoor air will become warmer.

Cooling Descriptions

- **For Normal Cooling**—Select the Cool mode and High or Med fan with a middle set temperature.
- **For Maximum Cooling**—Select the Cool mode and High fan with a lower set temperature.
- **For Quieter and Nighttime Cooling**—Select the Cool mode and Low fan with a middle set temperature.

NOTE: If the air conditioner is off and is then turned on while set to a **Cool** setting or if turned from a fan setting to a **Cool** setting, it may take approximately 3 minutes for the compressor to start and cooling to begin.

FAN ONLY MODE

Use the Fan Only Mode at Low, Med or High fan speed to provide air circulation and filtering without cooling. Since fan-only settings do not provide cooling, a Set temperature cannot be entered. The room temperature will appear in the display.

AIR DIRECTION

Use the lever to adjust the air direction left to right.

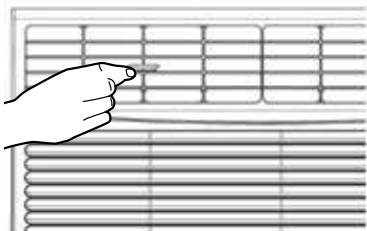

AUTO FAN MODE

Set to Auto for the fan speed to automatically set to the speed needed to provide optimum comfort settings with the set temperature. If the room needs more cooling, the fan speed will automatically increase. If the room needs less cooling, the fan speed will automatically decrease.

ECO MODE

Controls the fan.

- **ON**—The fan will cycle on and off with the compressor. This may result in wider variations of room temperature and humidity. **NOTE:** the fan may continue to run for a short time or may pulse intermittently after the compressor cycles off to sample the room air.
- **OFF**—The fan runs all the time, while the compressor cycles on and off.

REMOTE CONTROLS

- To ensure proper operation, aim the remote control at the signal receiver on the air conditioner.
- The remote control signal has a range of up to 20 feet.
- Make sure nothing is between the air conditioner and the remote control that could block the signal.
- Make sure batteries are fresh and installed correctly as indicated on the remote control.

NOTE: Do Not Operate in Freezing Outdoor Conditions: This cool-only air conditioner was not designed for freezing outdoor conditions. It must not be used when the outdoor temperature is below freezing (32°F).

CARE AND CLEANING

MAINTENANCE

GRILLE AND CASE

- Turn the air conditioner off and remove the plug from the wall outlet before cleaning.
- Clean filter by using warm water and a mild detergent. Do not use bleach or abrasives.

AIR FILTER

The air filter should be checked and cleaned at least every 30 days.

To Remove

- Slide the filter from the left side of the unit. Remove the filter.
- Clean the filter with warm, soapy water. Rinse and let the filter dry before replacing it. Do not place filter in a dishwasher.

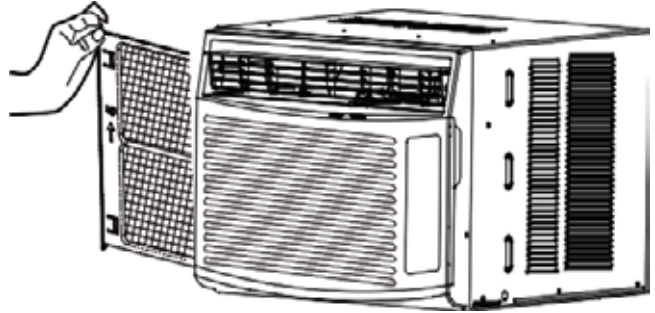

CAUTION

DO NOT operate the air conditioner without a filter as this will cause dirt and lint to build up and will reduce the performance of the unit.

OUTDOOR COILS

The coils on the outdoor side of the air conditioner should be checked regularly. If they are clogged with dirt or soot, they may need to be professionally cleaned.

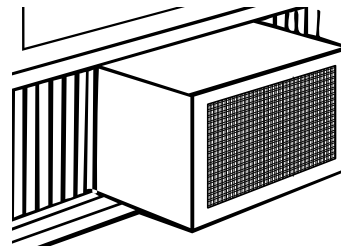

INSERTING AND REPLACING BATTERIES

- ❶ To insert batteries, slide down back cover of the remote control to expose the battery compartment.
- ❷ Insert batteries accordingly, matching the (-) and (+) terminals of the battery.
- ❸ Slide cover in the upward position to close battery compartment.

NOTE: 2 AAA batteries are included.
Remove batteries from packaging and place batteries into the remote

INSTALLATION INSTRUCTIONS

BEFORE YOU BEGIN

Read these instructions completely and carefully.

- **IMPORTANT** – Save these instructions for local inspector's use.
- **IMPORTANT** – Observe all governing codes and ordinances.
- **Note to Installer** – Be sure to leave these instructions with the Consumer.
- **Note to Consumer** – Keep these instructions for future reference.
- **Skill Level** – Installation of this appliance requires basic mechanical skills.
- **Completion Time** – Approximately 1 hour.
- We recommend that two people install this product.
- Proper installation is the responsibility of the installer.
- Product failure due to improper installation is not covered under the Warranty.
- You **MUST** use all supplied parts and use proper installation procedures as described in these instructions when installing this air conditioner.

ELECTRICAL REQUIREMENTS

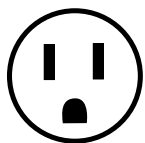

This model requires:

- 115/120-volt AC, 60-Hz grounded outlet protected with a 15-amp time-delay fuse or circuit breaker.
- The 3-prong grounding plug minimizes the possibility of electric shock hazard. If the wall outlet you plan to use is only a 2-prong outlet, it is your responsibility to have it replaced with a properly grounded 3-prong wall outlet.

CAUTION

- Do not, under any circumstances, cut or remove the third (ground) prong from the power cord.
- Do not change the plug on the power cord of this air conditioner.
- Aluminum house wiring may create issues - consult a qualified electrician.

The power cord includes a current interrupter device. A test and reset button are provided on the plug case. The device should be tested on a periodic basis by first pressing the **TEST** button and then the **RESET** button while plugged into the outlet. If the **TEST** button does not trip or if the **RESET** button will not stay engaged, discontinue use of the air conditioner and contact a qualified service technician.

TOOLS REQUIRED



Phillips Head
Screwdriver

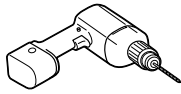

Drill and
1/8" Drill Bit



Pencil

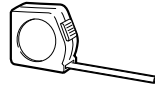

Ruler or
Tape Measure



Level



Scissors
or Knife

PARTS INCLUDED

(Appearance may vary)

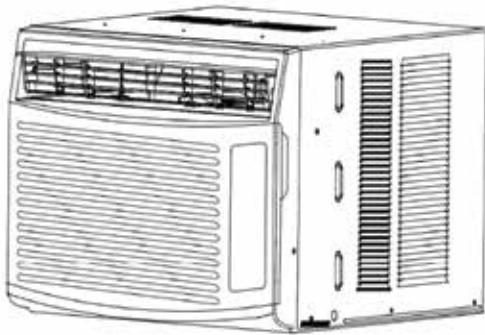

Air Conditioner

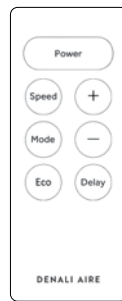

Remote Control

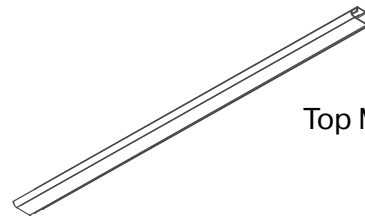

Top Mounting Rail

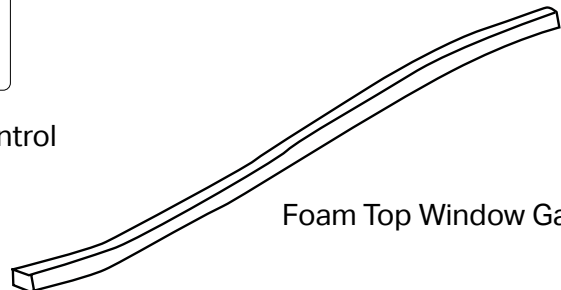

Foam Top Window Gasket

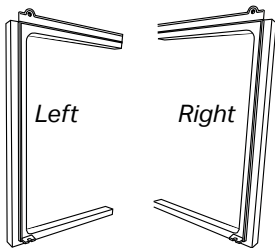

Side Curtain
Frame

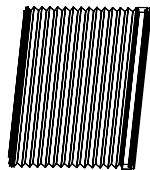

Side Curtain
(2)



Type A
(3)

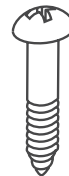

Type B
(9)

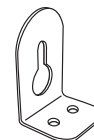

Side
Brackets (2)



Window Locking
Bracket (1)

IMPORTANT NOTICE: PROHIBITED INSTALLATION

DO NOT install this window air conditioner inside a wall sleeve or through a wall.

It is strictly forbidden and will void the warranty. The unit is designed for window mounting only, and any other installation may cause operational failure, airflow obstruction, water leakage, and electrical hazards.

It is essential to ensure that no air vents on any side of the air conditioner are blocked or partially blocked during installation and usage.

For safety and warranty coverage, follow the user manual instructions and install the unit properly in a window, ensuring unobstructed airflow around all sides of the unit.

1 WINDOW REQUIREMENTS

- These instructions are for a standard double-hung window. You will need to modify them for other types of windows.
- The air conditioner can be installed without the side curtain panels if needed to fit in a narrow window. See the window opening dimensions.
- All supporting parts must be secured to firm wood, masonry or metal.
- The electrical outlet must be within reach of the power cord.
- Follow the dimensions in the table and illustration for your model.
- DO NOT install this window air conditioner inside a wall sleeve or through a wall.

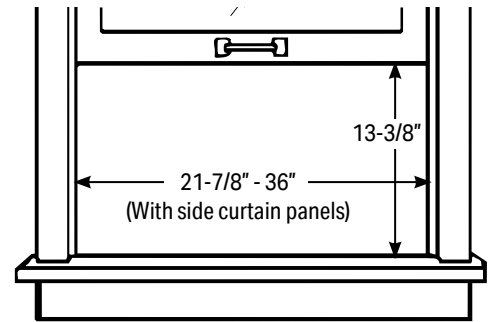

2 STORM WINDOW REQUIREMENTS

- A storm window frame will not allow the air conditioner to tilt toward the outside and will keep it from draining properly. To adjust for this, attach a piece of wood to the sill.

WOOD PIECES

- **Width:** 2"
- **Length:** Long enough to fit inside the window frame.
- **Thickness:** To determine the thickness, place a piece of wood on the sill to make it 1/2" higher than the top of the storm window frame or the vinyl frame.
- Attach securely with nails or screws provided by the installer.

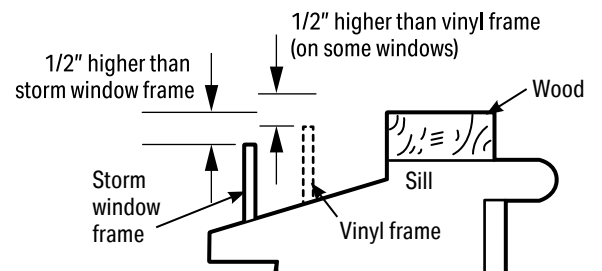

3 PREPARE THE AIR CONDITIONER

- A. Screw the top mounting rail onto the top of the AC with 3 Type A screws.
- B. Slide the curtain panels into the side panel rails.
- C. Slide left and right side curtain frames into top and bottom rails. Make sure that side curtains snap into side of the frames.

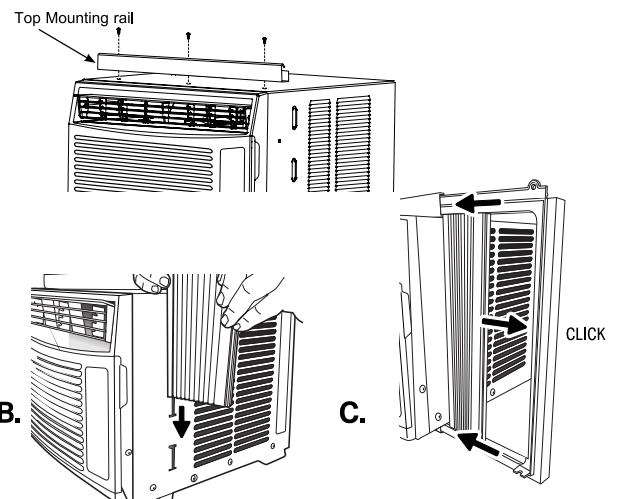

4 INSTALL THE AIR CONDITIONER IN THE WINDOW

- Measure the width of the window opening and mark the center line on the inside windowsill. Place the unit in the window. Lower the window to hold unit in place.
- Set the air conditioner in the window so that it is centered. Place the air conditioner so that front edge of the bottom mounting rail is against the back edge of the sill.
- Install the side bracket into the unit and into the windowsill using two 1" wood screws provided. Repeat on other side.
- Bring the window down so that the front edge of the top mounting is in front of the window. Make sure that the air conditioner is tilted slightly to the outside, minimum 5 degrees (see diagram).
- Extend the curtain panels until they fill the window. Mark the location of the holes in each corner. Use the drill and 1/8" drill bit to drill pilot holes. Use 4 Type B screws to secure the side panels in place.

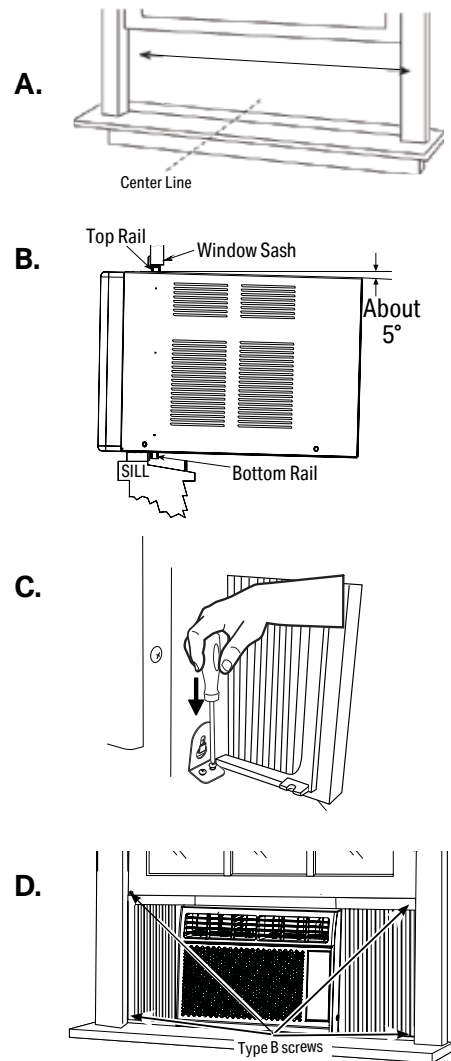

5 INSTALL WINDOW LOCKING BRACKET AND FOAM TOP WINDOW GASKET

- Use Type B Screw to install the window lock bracket on top of the bottom window.

CAUTION

If you have vinyl or other similarly constructed windows, attach the window locking bracket to the window side jamb with one Type B screw to prevent broken glass or damage to windows.

- Cut the foam top window gasket to the window width.
- Stuff the foam between the glass and the window to prevent air and insects from getting into the room.

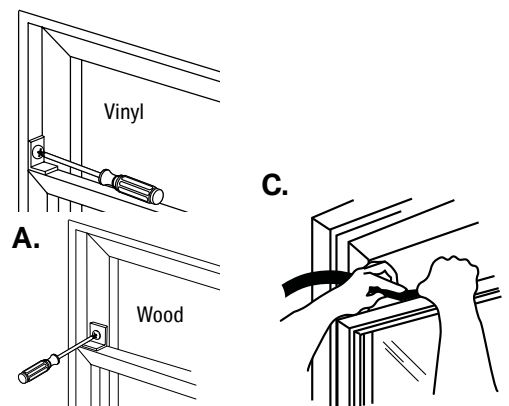

NOTE: If the gasket supplied does not fit your window, obtain the appropriate material locally to provide a proper installation seal.

TROUBLESHOOTING TIPS

Review the chart for Troubleshooting Tips. If issue persists, please call for further assistance.

ISSUE	POSSIBLE CAUSE	WHAT TO DO
Air conditioner does not start	The unit is unplugged	Make sure the air conditioner plug is pushed completely into the outlet.
	The fuse is blown/circuit breaker is tripped	Check the house fuse/circuit breaker box and replace the fuse or reset the breaker.
	Power failure	The unit will automatically restart in the setting last used after the power is restored. There is a protective time delay (approximately 3 minutes) to prevent tripping of the compressor overload. For this reason, the unit may not start normal cooling for 3 minutes after it is turned back on.
	The current interrupter device is tripped	Press RESET button located on the power cord plug. If the RESET button will not stay engaged, discontinue use of the air conditioner and contact a qualified service technician.
Air conditioner does not cool as it should	Indoor airflow is restricted	Make sure there are not curtains, blinds or furniture blocking the front of the air conditioner.
	The temp control may not be set properly	Turn the temperature control to a higher number.
	The air filter is dirty	Clean the filter at least every 30 days. See Care and Cleaning section.
	The room may have been hot	When the air conditioner is first turned on, you need to allow time for the room to cool down.
	Cold air is escaping	Check for open furnace registers and cold air returns.
	Cooling coils have iced up	See "Air conditioner freezing up" below.
Air conditioner freezing up	Ice blocks the air flow and stops the air conditioner from cooling the room	On models with control knobs, set the mode control at High Fan or High Cool with the Temp at 1 or 2. May have lost refrigerant.
Water drips outside	Hot, humid weather	This is normal.
Water drips inside	The air conditioner is not tilted to the outside	For proper disposal, make sure the air conditioner slants slightly from the case front to the rear.
Water collects in base pan	Moisture removed from air and drain into base pan	This is normal for a short period in areas with little humidity; normal for a longer period in very humid areas.

NORMAL OPERATING SOUNDS

- You may hear a pinging noise caused by water being picked up and thrown against the condenser on rainy days or when the humidity is high. This is normal, unit is equipped with a slinger blade which scoops up the water from the drain pan and throws it onto the coils for better efficiency.
- You may hear the thermostat click when the compressor cycles on and off.
- The fan may run even when the compressor does not.

DRAIN PLUG

- The unit is equipped with a slinger blade which scoops up the water from the drain pan and throws it onto the coils to cool them. See diagram below showing the location of your machine's drain plug.
- Water will collect in the base pan during high humidity or on rainy days. The water may overflow and drip from the outdoor side of the unit. The drain plug may be removed for quicker drainage.
- Drain plug removal may reduce cooling and energy efficiency.
- DO NOT DRILL ANY HOLES.
Doing so can harm the unit's internal components, void warranty, and invite pests and debris. Trust the manufacturer's design for efficient condensation management, preserving your unit's performance, longevity, and safety.

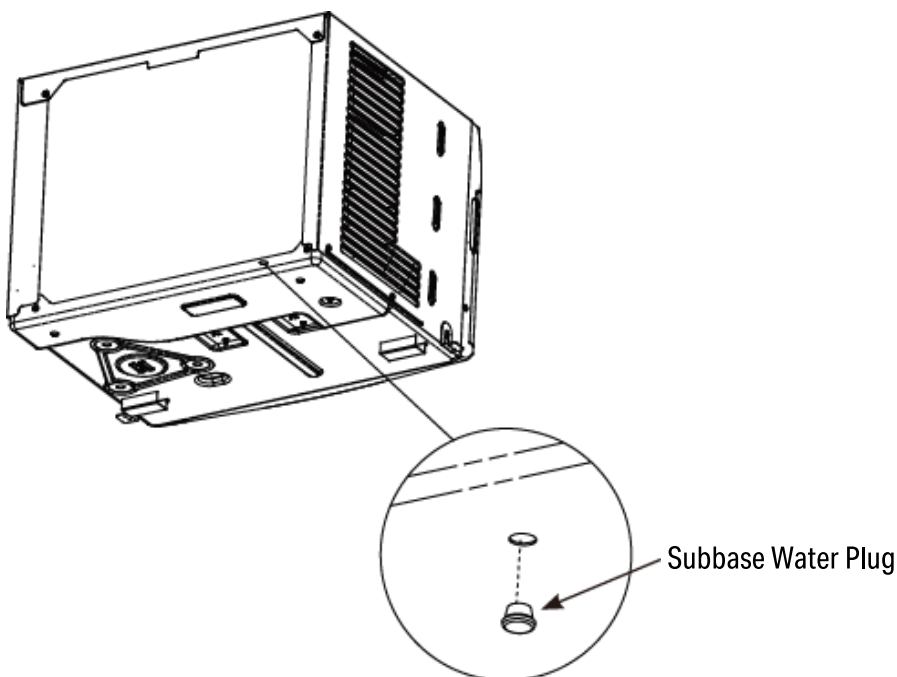



5401 Dansher Road
Countryside, IL 60525

888-433-6254 | support@denali-aire.com | www.denali-aire.com