

Hampshire Freestanding Bathtub

HAM-N-SW-OF + FT-HAM-XX

Top view

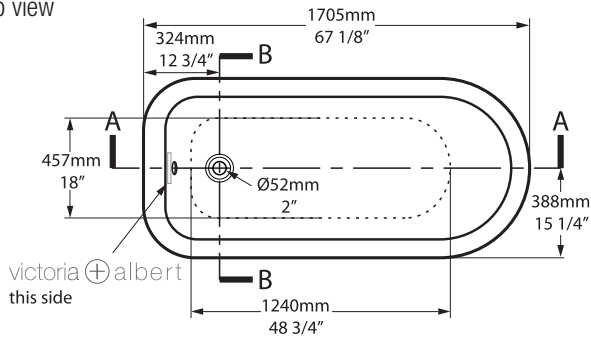

Front view

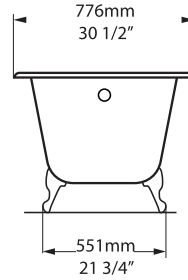

Section BB

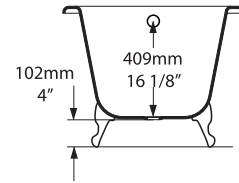

Side view

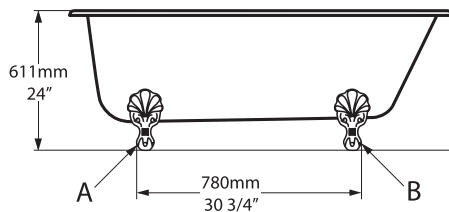

Rim detail

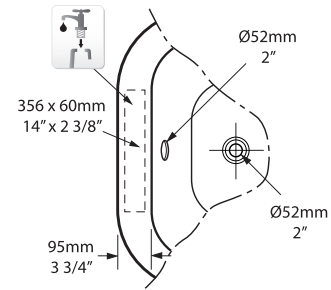
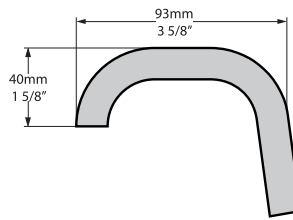

Side View

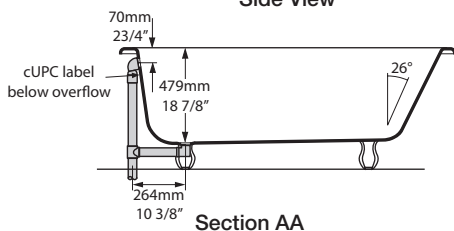

Section AA



Faucet holes can be drilled by installer
Les trous de robinetterie peuvent être percés par l'installateur
Pueden ser perforados por el instalador

- | | | |
|------------------------------|-----------|-----------|
| | | |
| FT-HAM-WH | FT-HAM-PC | FT-HAM-PB |
| | | |
| FT-HAM-BN | FT-HAM-PN | FT-HAM-SW |
| WH White Metal | | |
| PC Polished Chrome | | |
| PB Polished Brass | | |
| BN Brushed Nickel | | |
| PN Polished Nickel | | |
| SW White VOLCANIC LIMESTONE™ | | |

Feet are supplied in the same colour as bath as standard.

Les pieds fournis seront de la même couleur que la baignoire.

Como estándar, los pies se suministran en el mismo color que la bañera.

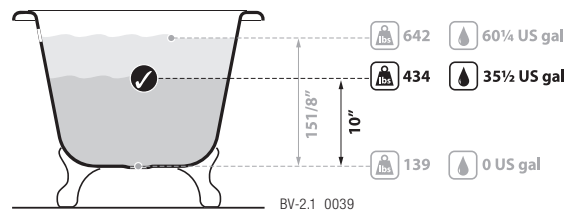

Recommended drain: K-50-xx



• All measurements subject to +/-5% tolerance
OF = overflow hole

25 years

25 year warranty for residential use (unpainted product)
Garantie de 25 ans pour un utilisation résidentiel (produit non peint)
Garantía de 25 años para uso domestico (productos no pintados)

5 years

5 year warranty on drains
Garantie de 5 ans sur les drains
Garantía de 5 años para los drenajes

8 years

8 year warranty for commercial use (unpainted product)
Garantie de 8 ans pour un usage commercial (produit non peint)
Garantía de 8 años para uso comercial (productos no pintados)

2 years

2 year warranty on painted exterior
Pour les finitions extérieures peintes la garantie est de 2 ans
Acabados de pintura exterior tienen una garantía de 2 años



Massachusetts Code: Approved
cUPC listing by IAPMO: File No. 6574

