

Tetra[®] EdgeStrip LED Lighting System



24
Volt

GEBI71-2, GEBI50-2, GEBI41-2, GEBI32-2



BEFORE YOU BEGIN

Read these instructions completely and carefully.

⚠ WARNING / AVERTISSEMENT

RISK OF ELECTRIC SHOCK

- Turn power off before inspection, installation or removal.
- Properly ground power supply enclosure.

RISK OF FIRE

- Use only UL approved wire for input/output connections. Minimum size 18 AWG (0.82mm²)
- Follow all NEC and local codes.
- Not to be submerged or used in a marine environment.

RISK OF FIRE OR ELECTRIC SHOCK

- LED Retrofit Kit installation requires knowledge of sign electrical systems. If not qualified, do not attempt installation. Contact a qualified electrician.
- Install this kit only in host signs that have been identified in the installation instructions and where the input rating of the retrofit kit does not exceed the input rating of the sign.
- Installation of this LED retrofit kit may involve drilling or punching of holes into the structure of the sign. Check for enclosed wiring and components to avoid damage to wiring and electrical parts.
- Do not make or alter any open holes in an enclosure of wiring or electrical components during kit installation.

RISQUES DE DÉCHARGES ÉLECTRIQUES

- Coupez l'alimentation avant l'inspection, l'installation ou le déplacement.
- Assurez-vous de correctement mettre à terre l'alimentation électrique.

RISQUES D'INCENDIE

- N'utilisez que des fils approuvés par UL pour les entrées/sorties de connexion. Taille minimum 18 AWG (0.82mm²)
- Respectez tous les codes NEC et codes locaux.
- Ne pas submerger ou installer dans un environnement marin.

RISQUE D'INCENDIE OU DE CHOC ÉLECTRIQUE

- L'installation de l'équipement de remplacement DEL exige la connaissance des systèmes électriques pour enseignes. Si non qualifié, ne tentez pas d'installation. Veuillez contacter un électricien qualifié.
- Risque d'incendie ou de choc électrique. Installez cet ensemble seulement dans des enseignes hôtes qui ont été identifiés dans les instructions d'installation et dont la capacité d'entrée de l'ensemble ne dépasse pas la capacité d'entrée de l'enseigne.
- L'installation de cet équipement de remplacement DEL peut impliquer le perçage ou le poinçonnage de trous dans la structure du panneau Vérifiez le câblage et les composants inclus pour éviter d'endommager le câblage et les composants électriques.
- Ne pas faire ou modifier les trous ouverts dans une enceinte de câblage ou de composants électriques pendant l'installation de cet équipement de remplacement DEL.

Prepare Electrical Wiring



Electrical Requirements

- Limited to use in dry and damp locations. The suitability of rain enclosures shall be determined if intended for wet location.
- The grounding and bonding of the LED Driver shall be done in accordance with National Electric Code (NEC) Article 600.
- Follow all National Electric Codes (NEC) and local codes.

Save These Instructions

Use only in the manner intended by the manufacturer.
If you have any questions, contact the manufacturer.

This device complies with part 15 of the FCC Rules. Operation is subject to the following two conditions: (1) This device may not cause harmful interference, and (2) this device must accept any interference received, including interference that may cause undesired operation.

Note: This equipment has been tested and found to comply with the limits for a Class A digital device, pursuant to part 15 of the FCC Rules. These limits are designed to provide reasonable protection against harmful interference when the equipment is operated in a commercial environment. This equipment generates, uses, and can radiate radio frequency energy and, if not installed and used in accordance with the instruction manual, may cause harmful interference to radio communications. Operation of this equipment in a residential area is likely to cause harmful interference in which case the user will be required to correct the interference at his own expense.

This Class [A] RFLD complies with the Canadian standard ICES-005. Ce DEFR de la classe [A] est conforme à la NMB-005 du Canada.

Components and Tools Required

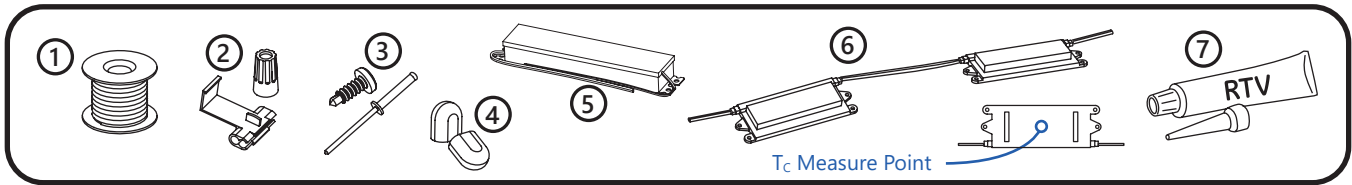

- ① UL approved 18 AWG (0.82 mm²) supply wire
- ② UL approved 22-14 AWG (0.33-2.08 mm²) wire connectors or 22-18 AWG (0.33-0.82 mm²) in-line/IDC connectors
- ③ #6 or #8 (M3 or M4) screws, 1/8 inch (3.2 mm) rivets or electrical grade silicone
- ④ End caps
- ⑤ 24 Volt Power Supply
- ⑥ Tetra® EdgeStrip LED modules
- ⑦ Electrical grade RTV silicone.
Example electrical grade RTV silicones include:
 - Momentive RTV 6700 Series Silicone Rubber Adhesive Sealant
 - Momentive White Blanc RTV 162 Silicone Rubber Adhesive Sealant-Electrical Grade
 - Dow Corning 3140 - Non-Corrosive Flowable (clear)
 - Dow Corning 3145 - Non-Corrosive Nonflowable (clear or gray)
 - Dow Corning RTV 748 Non-Corrosive Sealant-White

Layout LED Modules

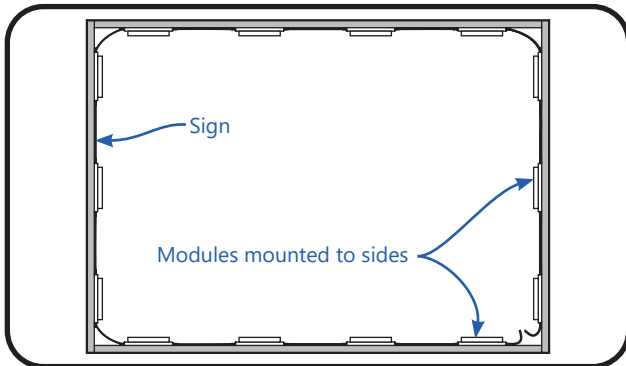

- ① Determine location of where LED modules will be mounted based on sign dimensions (see chart). If mounting on bottom of sign, the use of a riser will be needed (minimum 1/8 in. distance between bottom surface and module).

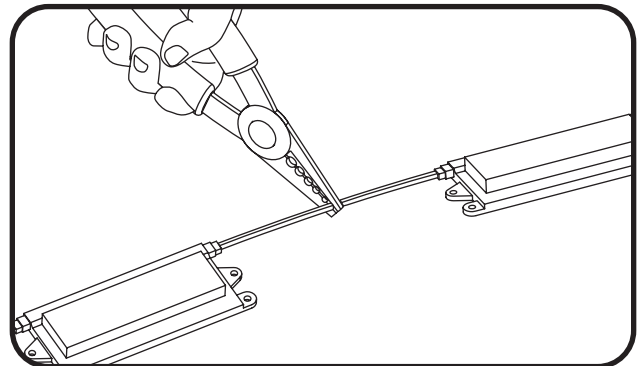

- ② Determine how many modules are required for your application and cut where necessary.
NOTE: Cuts can be made between any of the LED modules.

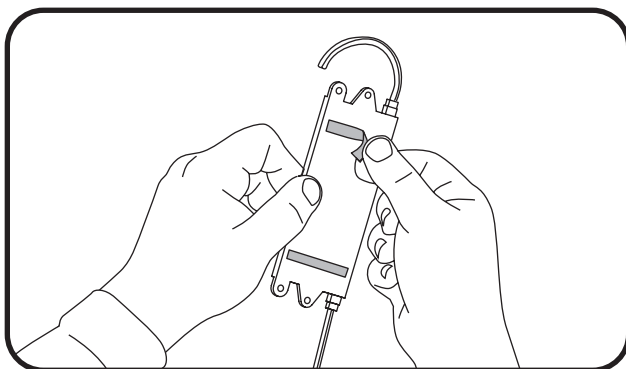

- ③ Peel off backing to expose adhesive tape and stick LED modules into place.

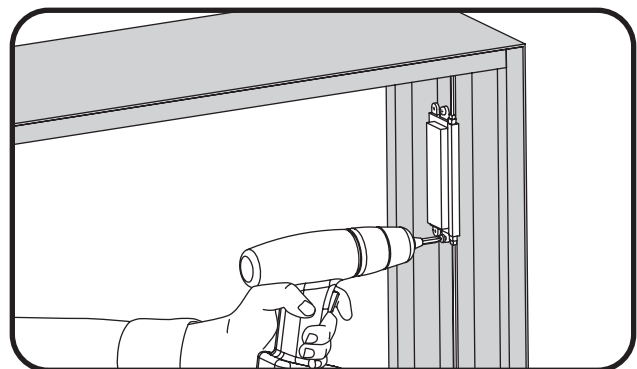

- ④ Use rivets, screws, or silicone to secure each module within the sign. Use #6 (M3) or #8 (M4) screws, 1/8-inch (3.2 mm) rivets, or silicone.

Electrical Connections

NOTE: Refer to the power supply installation instructions for loading and remote mounting information.

NOTE: Do not use connectors pre-filled with silicone grease/mineral base protective grease or use silicone grease to seal connections.

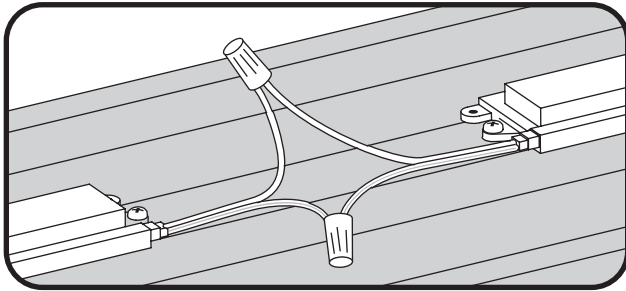

- 1 Connect modules using twist-on wire connectors or in-line (IDC) connectors. Join white wires together and red striped wires together.

NOTE: Additional supply wire may be necessary to bridge electrical connections.

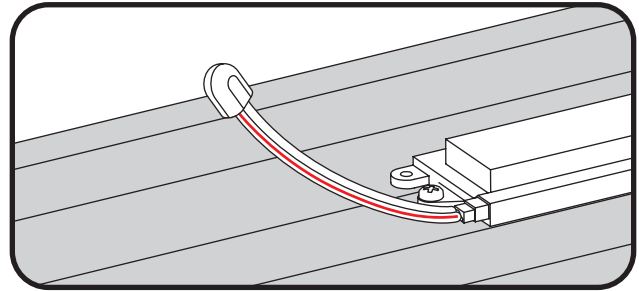

- 2 Cap all exposed wires with appropriate end caps or apply electric grade (non-corrosive) silicone for additional weather protection.

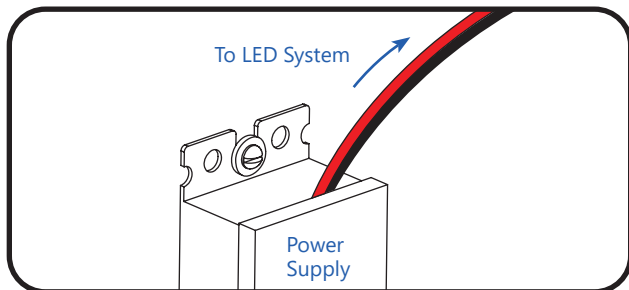

- 1 Run a wire from the Power Supply and connect to the first LED module on the strip.
Must be used with a class 2 24 Volt DC Power Supply. .

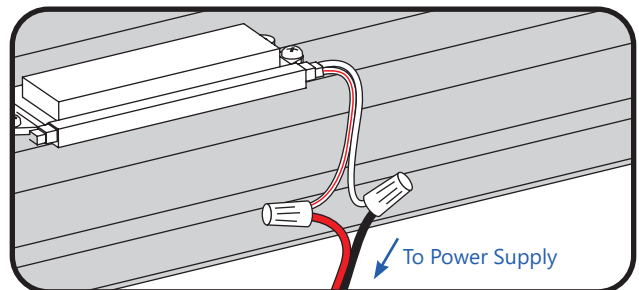

- 2 Connect the red stripe wire (+) of the LED system to the red wire (+) of the power supply. Connect the white wire (-) of the LED system to the black or blue wire (-) of the power supply.

NOTE: All electrical connections should be made within the box sign.

NOTE: All electrical connections should be suitably protected from mechanical damage and the environment. Seal all connections in locations that may be exposed to water with electrical grade RTV silicone.

Troubleshooting

Symptom	Solution
Row of modules does not light	<ul style="list-style-type: none"> • Check wire connections to power supply to ensure red stripe-to-red and white-to-black or blue connections. • Check row-to-row polarity connections.
Sign does not light	<ul style="list-style-type: none"> • Check input and output voltage and check power supply input/output connections. • Check polarity connections. • Ensure the overall length of the Tetra® LED System does not exceed the maximum load.
Individual modules do not light	<ul style="list-style-type: none"> • Remove module and replace with another working module.
Modules are dim	<ul style="list-style-type: none"> • Ensure the overall length of the Tetra® LED system does not exceed the maximum load. • Ensure the length and gauge of the supply wire is equal to or below the recommended remote mounting distance.

Design Guidelines

All guidelines are based on a 3 in. (76mm) deep sign for Tetra® EdgeStrip. When installing the modules, it is typically recommended to install the modules across the longest distance to allow for the shortest light throw.

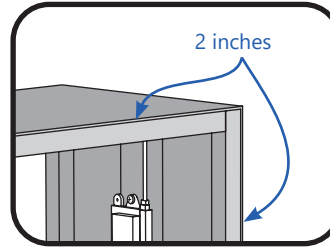

A 2 in. (51 mm) border is recommended along the perimeter of the sign.

		Height						
		1 ft. (0.30 m)	2 ft. (0.61 m)	3 ft. (0.91 m)	4 ft. (1.22 m)	5 ft. (1.52 m)	6 ft. (1.83 m)	7 ft. (2.13 m)
Width	1 ft. (0.30 m)	<u>EdgeStrip: 1 side</u> Modules/side: 1	<u>EdgeStrip: 1 side</u> Modules/side: 2	<u>EdgeStrip: 1 side</u> Modules/side: 3	<u>EdgeStrip: 1 side</u> Modules/side: 4	<u>EdgeStrip: 1 side</u> Modules/side: 5	<u>EdgeStrip: 1 side</u> Modules/side: 6	<u>EdgeStrip: 1 side</u> Modules/side: 7
	2 ft. (0.61 m)	<u>EdgeStrip: 1 side</u> Modules/side: 2	<u>EdgeStrip: 1 side</u> Modules/side: 3	<u>EdgeStrip: 1 side</u> Modules/side: 5	<u>EdgeStrip: 1 side</u> Modules/side: 6	<u>EdgeStrip: 1 side</u> Modules/side: 8	<u>EdgeStrip: 1 side</u> Modules/side: 9	<u>EdgeStrip: 1 side</u> Modules/side: 11
	3 ft. (0.91 m)	<u>EdgeStrip: 1 side</u> Modules/side: 3	<u>EdgeStrip: 1 side</u> Modules/side: 5	<u>EdgeStrip: 2 sides</u> Modules/side: 5	<u>EdgeStrip: 2 sides</u> Modules/side: 6	<u>EdgeStrip: 2 sides</u> Modules/side: 8	<u>EdgeStrip: 2 sides</u> Modules/side: 9	<u>EdgeStrip: 2 sides</u> Modules/side: 11
	4 ft. (1.22 m)	<u>EdgeStrip: 1 side</u> Modules/side: 4	<u>EdgeStrip: 1 side</u> Modules/side: 6	<u>EdgeStrip: 2 sides</u> Modules/side: 6	<u>EdgeStrip: 4 sides</u> Modules/side: 6	<u>EdgeStrip: 4 sides</u> Modules/side: 6-8	<u>EdgeStrip: 4 sides</u> Modules/side: 6-9	<u>EdgeStrip: 4 sides</u> Modules/side: 6-11
	5 ft. (1.52 m)	<u>EdgeStrip: 1 side</u> Modules/side: 5	<u>EdgeStrip: 1 side</u> Modules/side: 8	<u>EdgeStrip: 2 sides</u> Modules/side: 8	<u>EdgeStrip: 4 sides</u> Modules/side: 6-8	<u>EdgeStrip:</u> Not Recommended	<u>EdgeStrip:</u> Not Recommended	<u>EdgeStrip:</u> Not Recommended
	6 ft. (1.83 m)	<u>EdgeStrip: 1 side</u> Modules/side: 6	<u>EdgeStrip: 1 side</u> Modules/side: 9	<u>EdgeStrip: 2 sides</u> Modules/side: 9	<u>EdgeStrip: 4 sides</u> Modules/side: 6-9	<u>EdgeStrip:</u> Not Recommended	<u>EdgeStrip:</u> Not Recommended	<u>EdgeStrip:</u> Not Recommended
	7 ft. (2.13 m)	<u>EdgeStrip: 1 side</u> Modules/side: 7	<u>EdgeStrip: 1 side</u> Modules/side: 11	<u>EdgeStrip: 2 sides</u> Modules/side: 11	<u>EdgeStrip: 4 sides</u> Modules/side: 6-11	<u>EdgeStrip:</u> Not Recommended	<u>EdgeStrip:</u> Not Recommended	<u>EdgeStrip:</u> Not Recommended

Retrofit Instructions

- (Existing Signs Only)** Prior to installation, survey the site for information regarding power and accessibility inside and outside the building. Ensure that the branch circuit supplying the existing transformer or ballast will be within the voltage ratings of the new LED power supply, and have a current rating not exceeding 20A, or that permitted by applicable local, state, or country electrical codes (whichever is less).
- (Existing Signs Only)** Remove the existing lighting equipment to be replaced, such as neon tubing or fluorescent tubes; and associated transformers and ballasts. Care should be taken not to break the existing neon or fluorescent tubes.
NOTE: Follow all federal and local regulations when disposing of neon tubing, fluorescent tubes, transformers and ballasts.
- (Existing Signs Only)** If removal of the existing lighting equipment eliminates the disconnect switch, as required by applicable local, state, or country electrical codes; a new disconnect switch must be installed.
- (Existing Signs Only)** Repair and seal any unused openings in the electrical enclosure. Openings greater than 12.7-mm (1/2-in) diameter require a metal patch secured by screws or rivets and caulked with non-hardening caulk. Smaller openings may be sealed with non-hardening caulk.
- Using the layout guidelines above, determine required number of LED modules required to illuminate the sign.
- A 24VDC Class 2 Power Supply, as listed below, must be used with this retrofit kit. Determine the number of Power Supplies required to power the number of LED modules required to illuminate the sign, so as not to overload the Power Supply chosen.
- Follow the instructions above to properly mount the LED modules.
- Connect the DC output of the power supply to the LED modules using the Electrical Connections instructions above.
- Connect the power unit to the supply in accordance with the applicable local, state, and country electrical codes, and the instructions found in the power supply installation guide.
- If required, the disconnect switch shall be installed by qualified personnel, in accordance with applicable local, state, and country electrical codes.

Maximum Loading per 24 VDC Class 2 Power Supply

Power Supply	GEBI71-2, GEBI50-2 GEBI41-2, GEBI32-2
Rating per module	24VDC, 2.52W per module
GEPS24-25U-NA <i>Load shall not exceed 1.04A</i>	9 modules/9 ft. (2.74 m)
GEPS24D-80U, GEPS24W-80 <i>Load shall not exceed 3.3A</i>	30 modules/30 ft. (9.15 m)
GEPS24-100U-GLX, USVI-100024FBA, USVI-100024FE, GEPS24-100U-GLX2/TT <i>Load shall not exceed 4.0A</i>	36 modules/36 ft. (10.97 m)
GEPS24-180U <i>Load shall not exceed 3.8A per each (of 2) output channels</i>	33 modules/33 ft. (10.06 m) per output channel 66 modules/66 ft. (20.12 m) per power supply
GEPS24-200U-GLX2 <i>Load shall not exceed 4.0A per each (of 2) output channels</i>	36 modules/36 ft. (10.97m) per output channel 72 modules/72 ft. (21.94 m) per power supply
GEPS24-300U-GLX2 <i>Load shall not exceed 4.0A per each (of 3) output channels</i>	36 modules/36ft. (10.98m) per output channel 108 modules/108 ft. (32.94 m) per power supply

Maximum Remote Mounting Distance

	18 AWG/0.82 mm ² Supply Wire	16 AWG/1.31 mm ² Supply Wire	14 AWG/2.08 mm ² Supply Wire	12 AWG/3.31 mm ² Supply Wire
25W Power Supply	120 ft./36.6 m	–	–	–
80W Power Supply	20 ft./6.1 m	25 ft./7.6 m	35 ft./10.6 m	40 ft./12.1 m
100W Power Supply	20 ft./6.1 m	25 ft./7.6 m	35 ft./10.6 m	40 ft./12.1 m
180W Power Supply	20 ft./6.1 m	25 ft./7.6 m	35 ft./10.6 m	40 ft./12.1 m
200W Power Supply	20 ft./6.1 m	25 ft./7.6 m	35 ft./10.6 m	40 ft./12.1 m
300W Power Supply	20 ft./6.1 m	25 ft./7.6 m	35 ft./10.6 m	40 ft./12.1 m

If you have any questions about these instructions or your specific application, please contact support at tetra.support@gecurrent.com.
For the latest install guides for your product go to: www.gecurrent.com

This product is intended solely for the use of non-residential signage lighting and is not intended for use in any other applications.
Conforms to the following standards:

IP66 rated: separate enclosure required for outdoor use, UL damp location rated

