

# Immersion™ Elite

## LED Refrigerated Display Lighting

End Mullion Lights for Vertical Cases

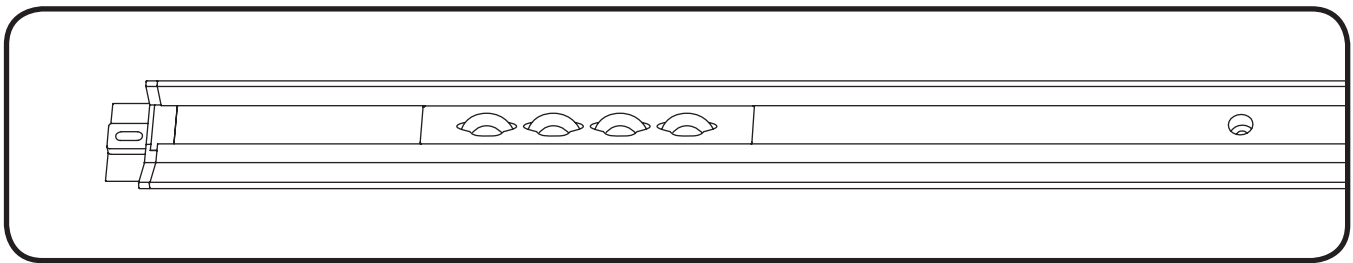

**ELV3 a b b c c d - e**

**Prefix:**

EL = Elite  
V = Vertical  
3 = Generation

**Light Output Class:**

E = Eco Output

**Length in inches:**

60 = 60 inches

**Color Temperature:**

50 = 5000K White

**Optic Configuration:**

C = Center  
R = Right  
L = Left

**Packaging:**

S = Single  
B = Bulk  
# = Custom



## BEFORE YOU BEGIN

Read these instructions completely and carefully.

### FOR YOUR SAFETY

Read and observe all **CAUTIONS** and **WARNINGS** shown throughout these instructions.

- Installation to be performed by factory trained service personnel only.
- For use inside a commercial refrigeration case with packaged foods only.
- Use this unit only in the manner intended by the manufacturer. If you have any questions, contact the manufacturer.
- Before installing, servicing or cleaning unit, switch power off at the service panel and follow appropriate lock out/tag out safety procedures

## Prepare Electrical Wiring

### Electrical Requirements



- The LED driver must be supplied the rated voltage as listed (LED Driver Compatibility), and connected to an individual properly grounded branch circuit, protected by a 15 or 20 ampere circuit breaker or time delay fuse.
- Wiring must be 2 wire with ground and rated for 75°C (167°F).
- Do not overload driver. Follow loading guidelines on page 6 of this installation guide.
- Ensure that all connection points are sealed for damp location using the appropriate method per the NEC or local electrical code.

### Led Driver Compatibility

This system is compatible with the following LED Drivers. Please refer to the separate LED driver installation guide for appropriate wiring connections.

LED Driver	Rated AC Input Voltage
GEPS6100NCCON-SY	120-240VAC, 60/50Hz
GELP24-100U-GLX	120-277VAC, 60/50Hz
GELP24-60U-GL	120-277VAC, 60/50Hz

### Tools Required

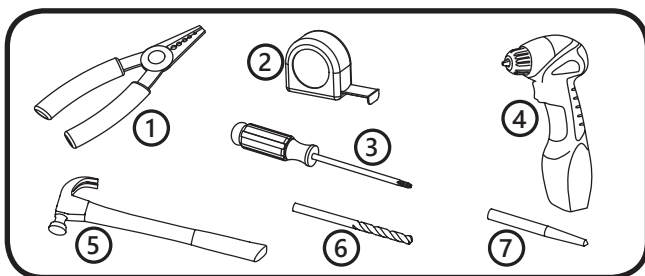

- ① Wire stripper/cutter
- ② Tape measure
- ③ Screwdriver
- ④ Cordless drill
- ⑤ Hammer
- ⑥ 7/64-inch (2.8mm) drill bit
- ⑦ Center punch

### Components Required

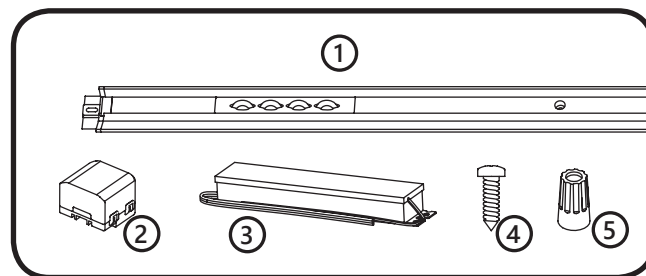

- ① LED light
- ② Wire cover
- ③ 24-volt, Class 2 (UL), SELV (CE), LED driver
- ④ 6-32 screws
- ⑤ UL certified 22-14 AWG (0.33-2.08 mm<sup>2</sup>) wire connectors

### Parts Needed Per Case

	6-Door	5-Door	4-Door	3-Door	2-Door
Center LED Lights	5	4	3	2	1
End LED Light Sets	1	1	1	1	1
Wire Covers	7	6	5	4	3
	Eco	Eco	Eco	Eco	Eco
<b>Using GELP24-60U-GL, GEPS6100NCCON-SY &amp; GELP24-100U-GLX LED Drivers</b>					
LED Drivers (60-inch LED Lights)	1	1	1	1	1

# 1 - Remove Existing Lighting Components

## ⚠ CAUTION / ATTENTION

**Risk of injury.** While performing installations described, gloves, safety glasses or goggles should be worn. / **Risque de blessure.** Lors de l'exécution des installations décrites, des gants, des lunettes de sécurité ou des lunettes de protection doivent être portées.

## ⚠ WARNING / AVERTISSEMENT

**Risk of electrical shock.** Disconnect power before servicing or installing product. LED Retrofit Kit Installation requires knowledge of luminaire electrical systems. If not qualified, do not attempt installation. Contact a qualified electrician. Install this kit only in the luminaires that have the construction features and dimensions shown in the photographs and/or drawings. / **Risque de choc électrique.** Couper le courant avant de réparer ou installer le produit. LED Retrofit Kit d'installation nécessite la connaissance des systèmes lumineux électriques. Si vous n'êtes pas qualifié, ne tentez pas l'installation. Contactez un électricien qualifié. Installez ce kit seulement dans les luminaires qui ont les caractéristiques de construction et les dimensions figurant sur les photographies et / ou des dessins.

- Refer to manufacturing manual for refrigeration case to identify lighting control circuits. Ensure that power is switched off at the service panel for the lighting circuit. If a lighting power switch is not provided in the refrigeration case, power removal can be performed at the main breaker panel.
- Please refer to refrigeration manual for any questions dealing with component locations.

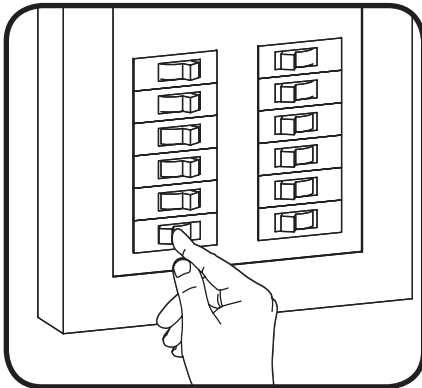

1 Turn off power to the refrigeration case.

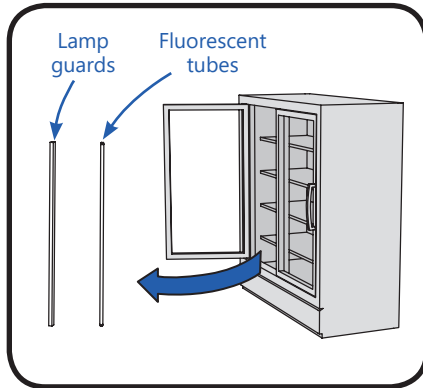

2 Remove all lamp guards and fluorescent tubes from inside the case.

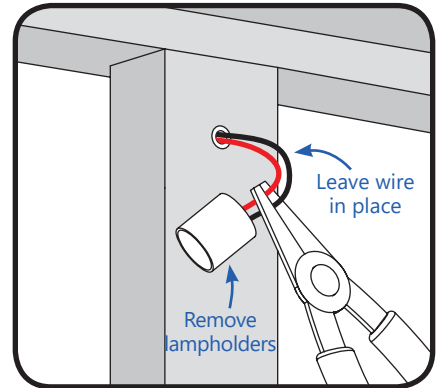

3 Inside the case, cut wires as close as possible to lampholders and remove them.

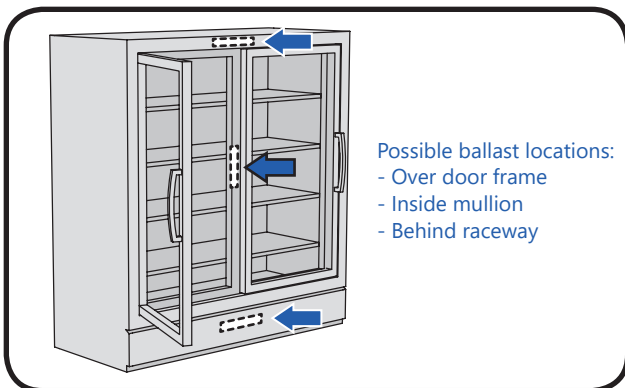

Possible ballast locations:  
 - Over door frame  
 - Inside mullion  
 - Behind raceway

4 Locate ballast and remove access cover.

**NOTE:** Refer to the refrigeration manual for specific ballast location.

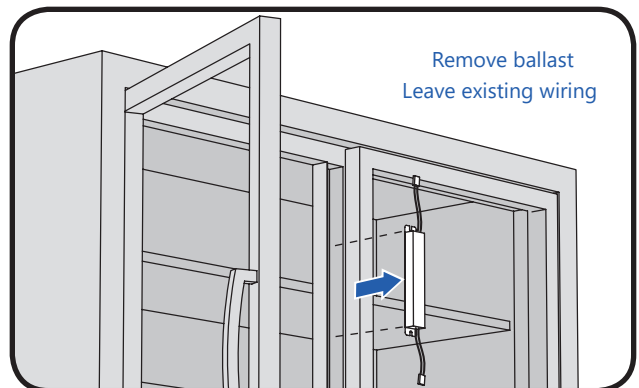

5 Disconnect wires to ballast and remove from case. Leave the existing ballast input and output wires for reconnection in a later step.

**NOTE:** Follow all federal and local regulations when disposing of fluorescent tubes, transformers and ballasts.

## 2 - Install End LED Lights

### ⚠ WARNING / AVERTISSEMENT

**Risk of fire or electric shock.** Luminaire wiring and electrical parts may be damaged when drilling for installation of LED retrofit kit. Check for enclosed wiring and components. / **Risque de feu ou électrocution.** Les pièces et câbles électriques risquent d'être endommagés lors du perçage des trous pour l'installation du luminaire à DEL. Veuillez vérifier si des câbles et composants se trouvent derrière la paroi avant de percer.

To prevent wiring damage or abrasion, do not expose wiring to edges of sheet metal or other sharp objects. / Pour éviter l'endommagement de câblage ou l'abrasion, ne pas exposer le câblage aux bords de feuilles de métal ou d'autres objets tranchants.

### ⚠ WARNING / AVERTISSEMENT

**Risk of electrical shock.** Only those open holes indicated in the photographs and/or drawings may be made or altered as a result of kit installation. Do not leave any other open holes in an enclosure of wiring or electric components / **Risque de choc électrique.** Seuls les trous ouverts indiqués dans les photos et / ou les dessins peuvent être faites ou modifiés à la suite du montage du kit. Ne pas laisser autres trous ouverts dans l'enceinte du câblage électrique ou composants.

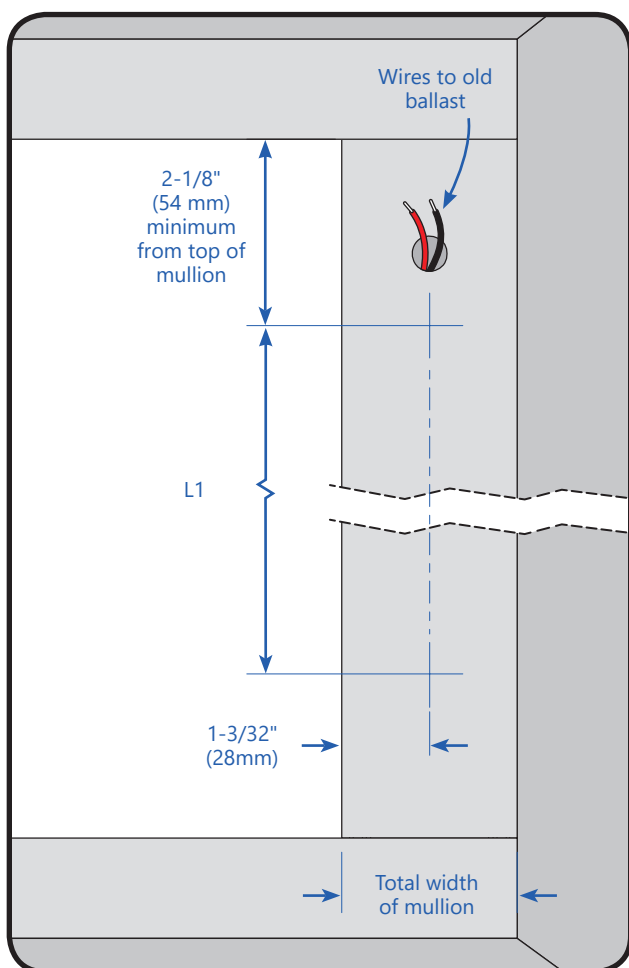

① Mark two hole locations on mullion.

LED Light Length	L1
60"	58.09"

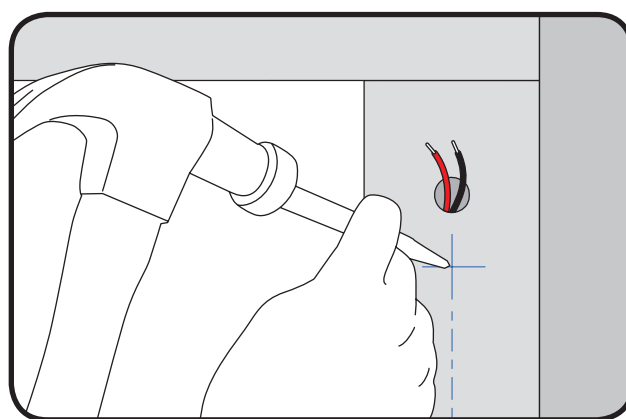

② Use center punch and hammer to create a dimple over the two marked locations.

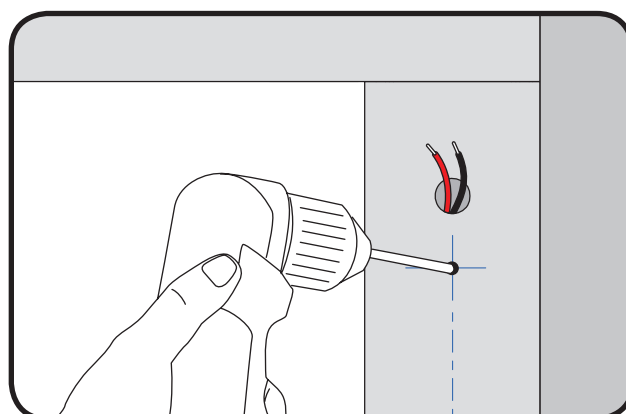

③ Use a 7/64" (2.8 mm) bit to drill mounting holes through the two marked locations.

**NOTE:** Refer to the manufacturing manual for door frame to ensure there are no components contained inside the mullion that could be drilled through.

Top view of refrigeration case

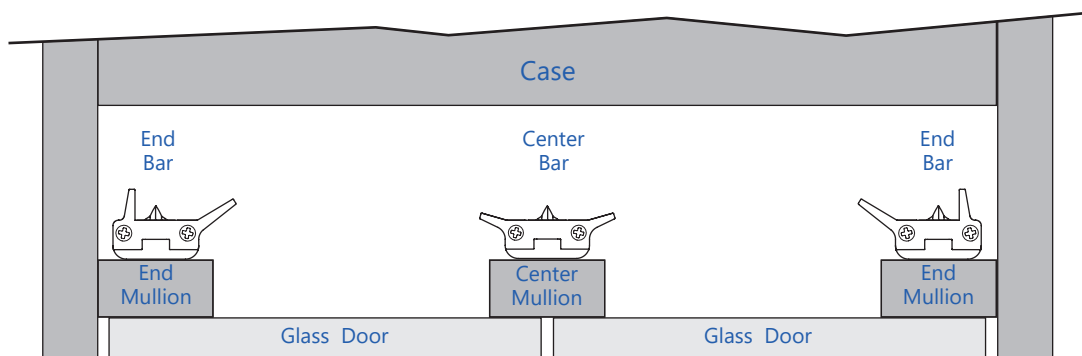

**IMPORTANT:** Before proceeding, verify correct orientation of lights.

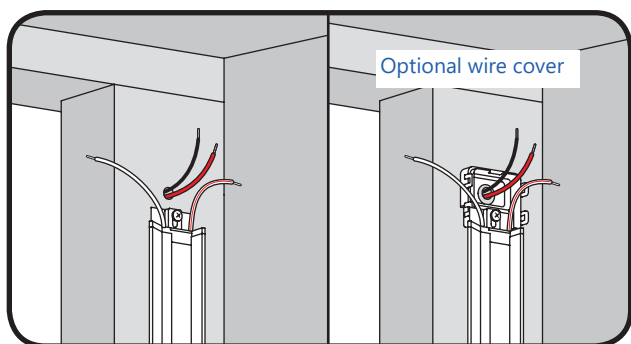

- ④ Secure the top and bottom of the LED light to the mullion using a #6 x 1/2" (self-threading) or x 3/4" (self-drilling) sheet metal screws. If using the optional wire cover, install the cover base as well and a 3/4" (self-threading) or x 1" (self-drilling) long screw will be required.

**OPTIONAL:** Additional screws can be used in the holes along the length of the bar if desired. Refer to the manufacturer manual for door frame to ensure there are no components contained inside the mullion that could be drilled through.

**NOTE:** Over-sized screws may cause damage to the LED light.

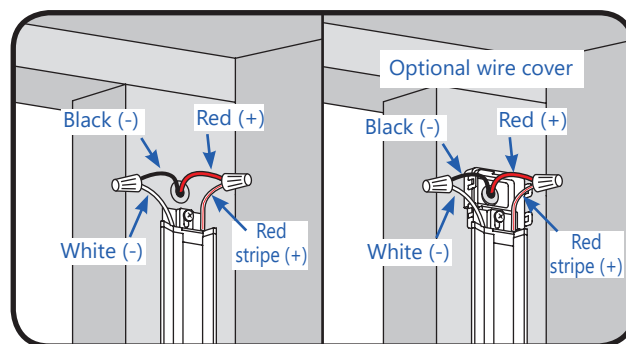

- ⑤ Refer to wiring diagram on page 7. Connect the red stripe wire (+) of the LED light to the red wire (+) of the power supply, and connect the white wire (-) of the LED light to the black wire (-) of the power supply using wire connectors or other connection method suitable for low temperature usage and stranded cable.

**NOTE:** If connections are made in an area with excessive moisture or ice, electrical connections should be sealed with electrical grade silicone. (Examples: Momentive RTV 6700 Series, Momentive White Blanc RTV 162, Dow Corning 3140, Dow Corning 3145, or Dow Corning RTV 748)

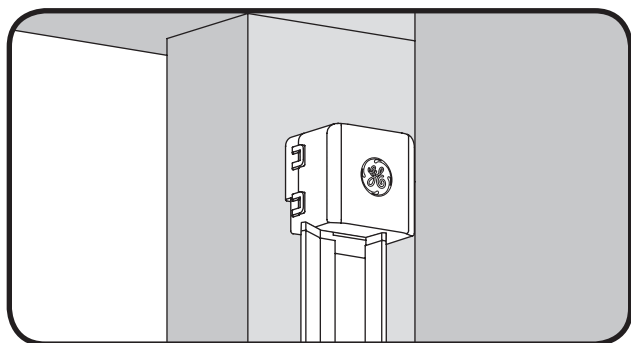

- ⑥ If using the optional wire cover, tuck wires inside and snap the cover top over the cover base. Repeat steps 1–6 for the other side of the case.

- ⑧ Proceed to section **4–Electrical Connections** to complete wiring connections.



- ⑦ Mount the LED driver in the same location where the ballast was formerly installed.

**NOTE:** Refer to the "Parts Needed Per Case" table on page 2 to determine the proper number of LED drivers to install.

### 3 - Electrical Connections

#### Maximum LED Driver Loading

**⚠ CAUTION / ATTENTION**

**Risk of injury.** Do not overload LED Driver. Do not exceed limits shown in "Maximum LED Driver Loading" table below.  
**Risque de blessure.** Ne pas surcharger l'alimentation. Ne pas exéder les limites de la table cidessous: "Charges maximales pour les alimentations."

Tier	Length	Bar Type	Light Bar Power (W)	LED Driver: GELP24-60U-GL		LED Drivers: GEPS6100NCCON-SY GELP24-100U-GLX	
				Minimum Loading QTY (Min loading > 20W)	Maximum Loading QTY (Max loading ~ 54W)	Minimum Loading QTY (Min loading > 40W)	Maximum Loading QTY (Max loading ~ 90W)
Eco	60"	Center	7.8	3	6	6	10
		End	4.3	5	11	10	18

#### Electrical Connection Configurations

Multiple LED light's electrical input should be in parallel connection to an LED driver's output as shown by the example wiring diagram. Refer to "Maximum LED Driver Loading" table above to determine maximum number of LED lights per LED driver.

**TIP!** - ELV3 series LED lights must be connected in the correct polarity. If the LED light does not illuminate when energized, verify that the white supply conductor with the red strip is connected to the positive supply, and the plain white supply conductor is connected to the negative supply.

One End Set (Right and Left) and One Center LED Light

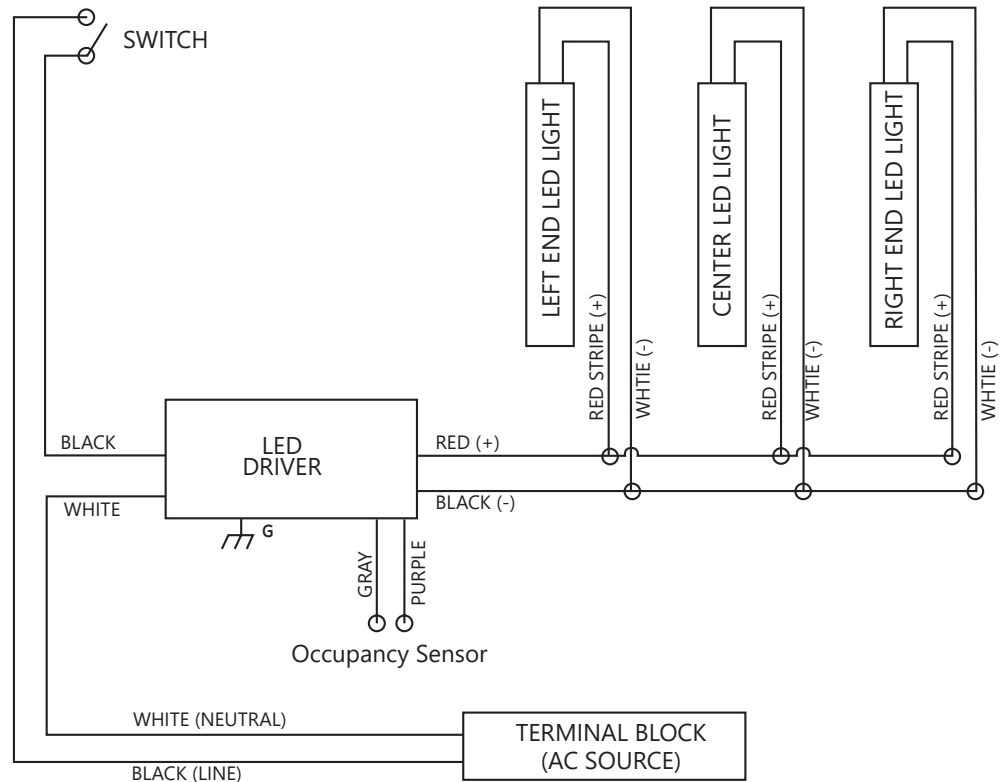

### Connecting a GEPS6100NCCON-SY Driver

- Make input and output connections according to diagrams below.
- Connection methods should be suitable for low temperature usage and standard cable.
- For non-dimming applications, cap the unused wires with 5/32" (4mm) twist on wire connectors.
- For dimming applications, cut the dimming loop on the driver output side and make connections to the occupancy sensor.
- **CAUTION:** DO NOT apply voltage or power to the switched control circuit – contact closure only.
- Other methods for automated control such as occupancy sensors that switch the AC power side on and off are not recommended and will void the product warranty.

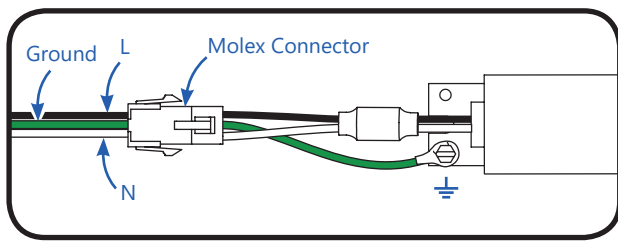
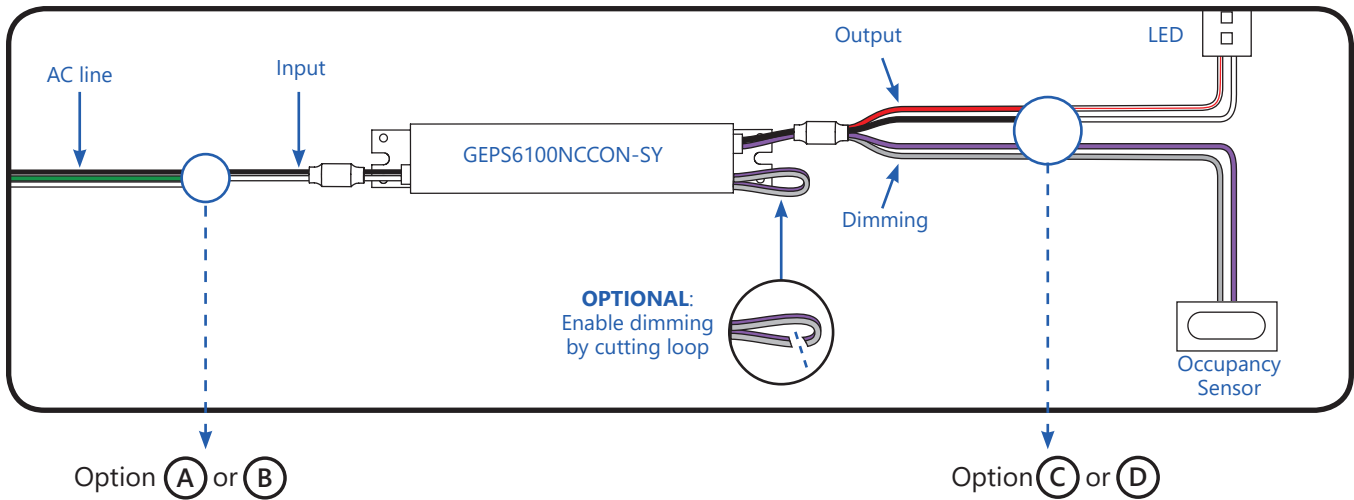

**(A)** Connect DC output using 4-way connector.

Wire Cavity Table	
<b>39-01-4030 (AC)</b>	
Cavity 1	Line 1 (Black)
Cavity 2	Earth Ground (Green)
Cavity 3	Neutral or Line 2 (White)

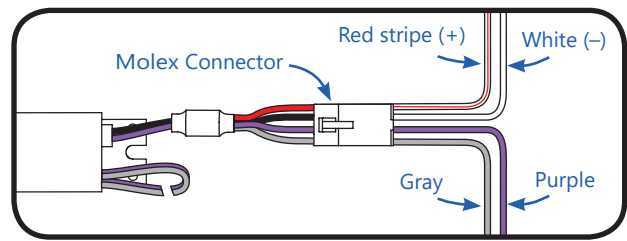

**(C)** Connect DC output using 4-way connector.

Wire Cavity Table	
<b>Molex 39-01-4046 (DC)</b>	
Cavity 1	Output DC (+) (Red)
Cavity 2	Output DC (-) (Black)
Cavity 3	Dimming (Purple)
Cavity 4	Dimming (Gray)

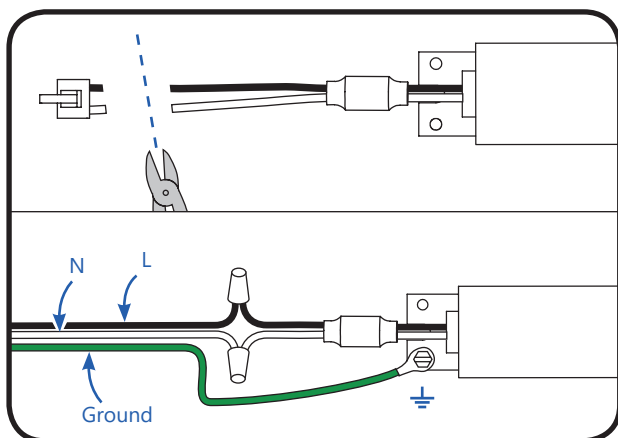

**(B)** Connect AC input using wire nuts.

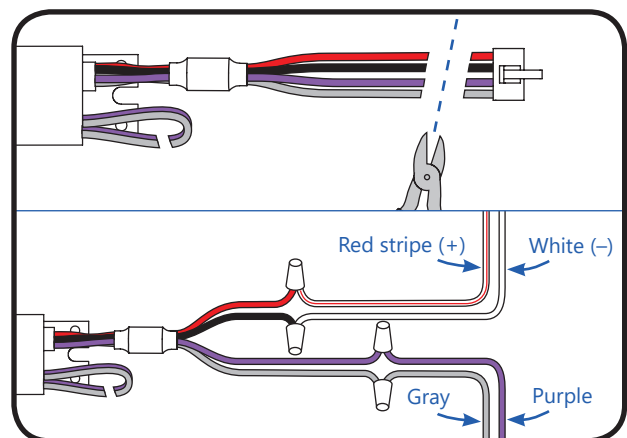

**(D)** Connect DC output using wire nuts.

## Connecting a GELP24-60U-GL or GELP24-100U-GLX Driver

- Make input and output connections according to diagrams below.
- Connection methods should be suitable for low temperature usage and standard cable.

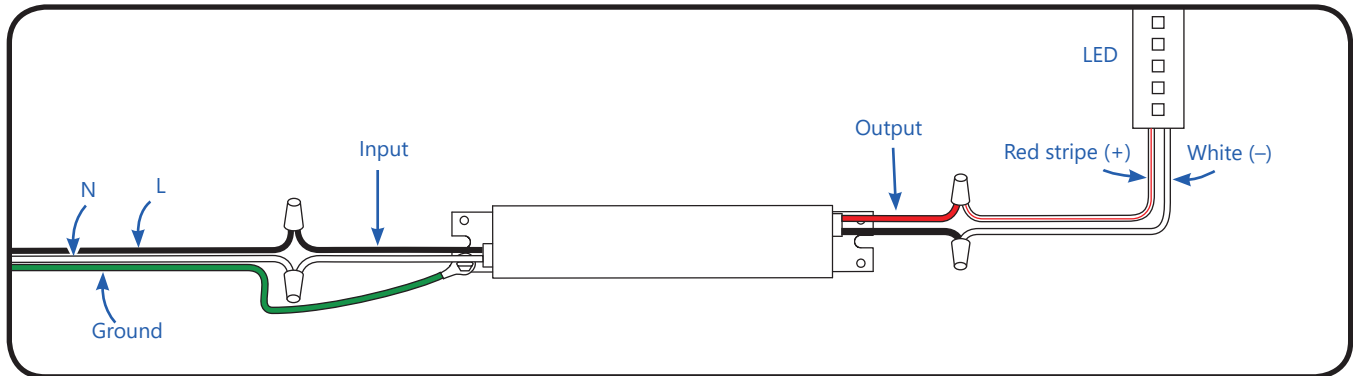

## Periodic Inspection

It is advised that a periodic inspection be made of the refrigerated display case and LED lights for proper function. If excessive moisture or ice buildup is noted, this may be a sign that the door seal is damaged and should be replaced. Please note that prolonged exposure of the LED lights to moisture and ice may result in damage to the LED lights. Any LED lights exhibiting signs of damage such as discoloration or LEDs that are out should be replaced.

## Cleaning Instructions

### ⚠ WARNING / AVERTISSEMENT

**Risk of electrical shock.** Disconnect power to LED Lights before any cleaning operation.

**Risque de choc électrique.** Débranchez l'alimentation des éclairages à LED avant toute opération de nettoyage.

- The outer lens should be cleaned periodically with a mild liquid dish detergent.
- Do not use chemical cleaners to clean the lens.
- Keep the outside clean. Wipe with a clean cloth lightly dampened with mild liquid dish detergent. Dry with a clean, soft cloth.
- Do not wipe the lens with a soiled dish cloth or wet towel. These may leave a residue that can damage the finish.
- Do not use scouring pads, powdered cleaners, bleach or cleaners containing bleach because these products can scratch and damage the finish.

This device complies with part 15 of the FCC Rules. Operation is subject to the following two conditions: (1) This device may not cause harmful interference, and (2) this device must accept any interference received, including interference that may cause undesired operation.

NOTE: This equipment has been tested and found to comply with the limits for a Class A digital device, pursuant to part 15 of the FCC Rules. These limits are designed to provide reasonable protection against harmful interference when the equipment is operated in a commercial environment. This equipment generates, uses, and can radiate radio frequency energy and, if not installed and used in accordance with the instruction manual, may cause harmful interference to radio communications. Operation of this equipment in a residential area is likely to cause harmful interference in which case the user will be required to correct the interference at his own expense.

This Class [A] RFLD complies with the Canadian standard ICES-005. /CeDEFr de la classe [A] est conforme à la NMB-005 du Canada.

This product is intended solely for the use of commercial refrigerated, display or case lighting and is not intended for use in any other application.