



CUSTOMER NAME \_\_\_\_\_

Project Name \_\_\_\_\_

Date \_\_\_\_\_ Type \_\_\_\_\_

Catalog Number \_\_\_\_\_

## Flex Edgelit Series

### Downlight

**Flex Edgelit** leverages advanced edgelit LED technology to produce an uniform and visually pleasing light with little to no glare in a clean, modern and aesthetically pleasing design. Available in multiple shapes and aperture sizes combined with universal voltage, tri-dimming capability and switchable technology all packed in an ultra thin 1/2" profile, the Flex Edgelit is ideal for a wide range of applications.

### Construction

<b>Housing:</b>	Cast Aluminum Trim
<b>Lens:</b>	Non-conductive polycarbonate
<b>Paint:</b>	Powder coat painted (White)
<b>Weight:</b>	LRXE 4" - 3.92lbs (1.78kg) LRXE 6" - 4.63lbs (2.10kg) LRXE 8" - 5.05lbs (2.29kg)
<b>Optical Assembly:</b>	Edgelit LED technology with diffuse polycarbonate lens

### Controls

**Dimming:** Tri-Dimming (0-10V @ Dim to off, TRIAC/ELV @ 5%)

### Ambient Temperature

TYPE	TEMPERATURE RATE
OPERATING TEMPERATURE	-10°C to +30°C (14°F to 86° F)

### Optical System

<b>Lumens:</b>	750 - 1800
<b>Distribution:</b>	Very Wide (90°)
<b>Efficacy:</b>	Up to 99 LPW
<b>CCT:</b>	Selectable (2700K, 3000K, 3500K, 4000K)
<b>CRI:</b>	90
<b>R9:</b>	>50

### Lumen Maintenance

LXX(10K) @ Hours	54,000 HR
L70	

### MOUNTING

- Direct install into 3.5in cutout
- Remote junction box with mounting keyholes.
- 13in cable with quick disconnect
- Remodel sleeve with adjustable mounting clips for up to 1in ceiling thickness
- Optional extension cables available up to 24in in length

### Design Life & Warranty

- Class 2 high-efficiency LED driver
- Suitable for wet locations
- Air-tight rated
- JA-8
- IC-Rated
- **Current's Limited 5-year Warranty:**  
Please refer to document [IND599](#) for more information.

### Electrical

<b>Input Voltage:</b>	120-277 V
<b>Input Frequency:</b>	50/60Hz
<b>Power Factor (PF)*:</b>	>90%*
<b>Total Harmonic Distortion (THD)*:</b>	<20%*
<b>Wattage:</b>	10W (4in), 13W (6in), 18W (8in)

\* PF and THD may vary with options



### CUSTOMER NAME

Project Name \_\_\_\_\_

Date \_\_\_\_\_ Type \_\_\_\_\_

Catalog Number \_\_\_\_\_

## Ordering Information

**LRXE**

**9**

**SW**

**RMT**

PRODUCT ID	SHAPE/SIZE	LUMEN	CRI	CCT	DIMMING	OPTIONS
LRXE = Lumination® Flex Downlight Edgelit	<b>R4</b> = 4" Round Downlight <b>S4</b> = 4" Square Downlight	<b>07</b> = 750lm	<b>9</b> = 90+ CRI	<b>SW</b> = Selectable 2700K/3000K/3500K/4000K	<b>(blank)</b> = Tri-Dimming	<b>RMT</b> = Remote Junction Box
	<b>R6</b> = 6" Round Downlight <b>S6</b> = 6" Square Downlight	<b>11</b> = 1,150lm				
	<b>R8</b> = 8" Round Downlight <b>S8</b> = 8" Square Downlight	<b>18</b> = 1,800lm				

MODEL	CATALOG NUMBER	WATTS	DELIVERED LUMENS			
			2700K	3000K	3500K	4000K
LRXE 4"	LRXER4079SWRMT	8.2	698	759	820	789
	LRXES4079SWRMT					
LRXE 6"	LRXER6129SWRMT	11.5	1037	1127	1217	1172
	LRXES6129SWRMT					
LRXE 8"	LRXER8199SWRMT	20.0	1621	1762	1903	1832
	LRXES8199SWRMT					

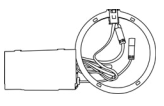
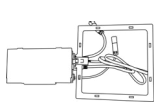
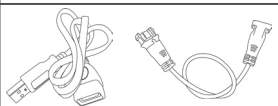
ACCESSORY	SKU	DESCRIPTION	SPECS
	93309531	AK-LRXER4-EMBB	EMBB Kit w/ Integral Test Switch, 4" Round
	93309532	AK-LRXER6-EMBB	EMBB Kit w/ Integral Test Switch, 6" Round
	93309533	AK-LRXER8-EMBB	EMBB Kit w/ Integral Test Switch, 8" Round
	93309534	AK-LRXES4-EMBB	EMBB Kit w/ Integral Test Switch, 4" Square
	93309535	AK-LRXES6-EMBB	EMBB Kit w/ Integral Test Switch, 6" Square
	93309536	AK-LRXES8-EMBB	EMBB Kit w/ Integral Test Switch, 8" Square
	93309537	AK-LRXE-EXT-12	Extension Cable for JBOX, 12"
	93309538	AK-LRXE-EXT-24	Extension Cable for JBOX, 24"
	93309539	AK-LRXE-EMBB-EXT-24	Extension Cable for EMBB kit, 24"

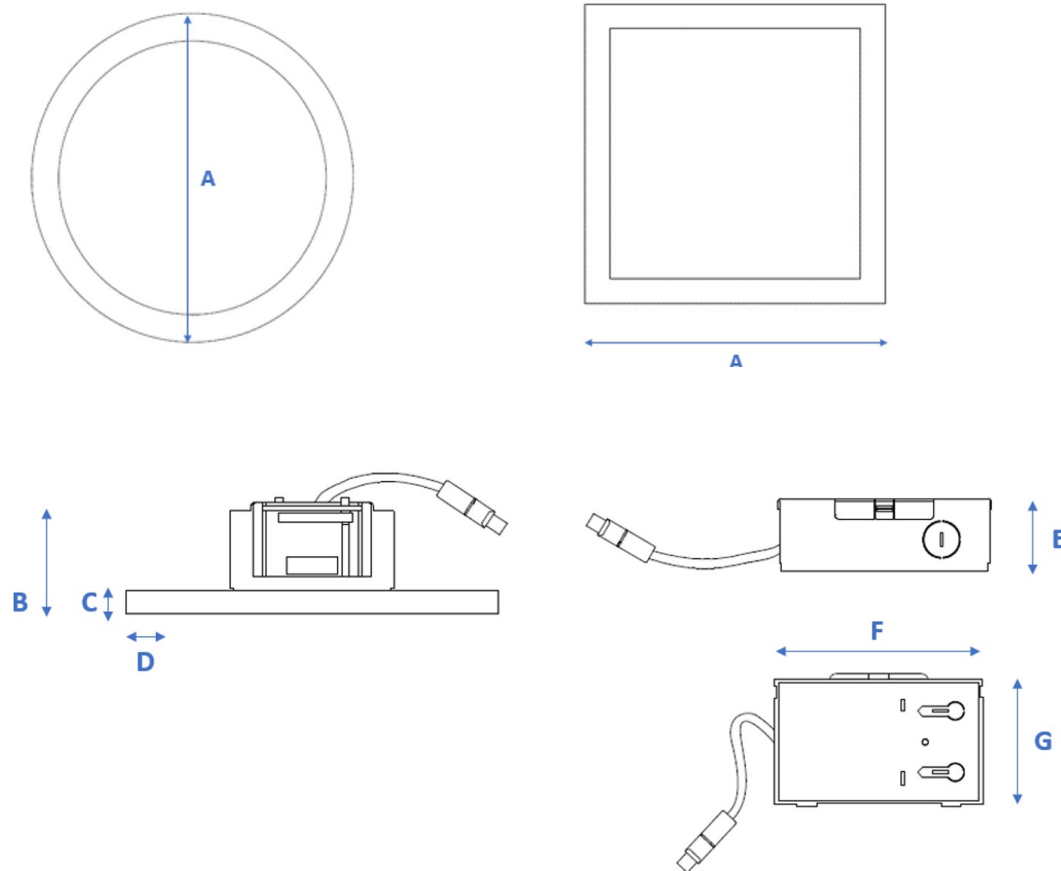
**Product Dimensions**

PRODUCT DIMENSIONS										
	A	B		C		D		E	F	G
	LIGHT ENGINE	LIGHT ENGINE HEIGHT	LIGHT ENGINE HEIGHT (EMBB)	FLANGE HEIGHT	FLANGE HEIGHT (EMBB)	FLANGE WIDTH	FLANGE WIDTH (EMBB)	J-BOX HEIGHT	J-BOX LENGTH	J-BOX WIDTH
<b>4" Round</b>	Ø 4.61" (117.1mm)	1.99" (50.5mm)	2.05" (52.1mm)	0.48" (12.2mm)	0.54" (13.7mm)	0.50" (12.7mm)	0.71" (18mm)	1.61" (40.9mm)	4.70" (119.4mm)	2.95" (74.9mm)
<b>6" Round</b>	Ø 6.00" (152.4mm)									
<b>8" Round</b>	Ø 8.00" (203.2mm)									
<b>4" Square</b>	□ 4.61" (117.1mm)	1.99" (50.5mm)	2.05" (52.1mm)	0.48" (12.2mm)	0.54" (13.7mm)	0.50" (12.7mm)	0.71" (18mm)	1.61" (40.9mm)	4.70" (119.4mm)	2.95" (74.9mm)
<b>6" Square</b>	□ 6.00" (152.4mm)									
<b>8" Square</b>	□ 8.00" (203.2mm)									

Ceiling Cutout	Ø 3.5" (88.9mm)
Ceiling Thickness	0.38" (9.7mm) - 1.0" (25.4mm)
Recommended plenum clearance	3.50" (88.9mm)
Recommended plenum clearance (EM)	4.25" (108.0mm)

### Photometric Data

#### 4" Round LRXE

**3500K**

750 LM

LRXER4079SWRMT

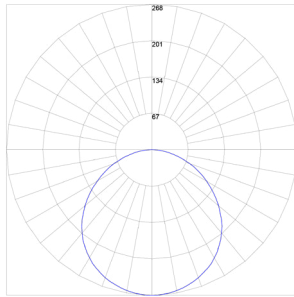

Maximum Candela = 267.84. Located At Horizontal Angle = 0, Vertical Angle = 0  
Vertical Plane Through Horizontal Angles (0 - 180) (Through Max. Cd.)

ZONE	LUMENS
0-10	25.37
10-20	72.90
20-30	111.39
30-40	135.15
40-50	139.68
50-60	124.50
60-70	94.07
70-80	55.54
80-90	16.45

ZONE	LUMENS	% OF FIXTURE
0-20	98.28	12.7
0-30	209.67	27.1
0-40	344.82	44.5
0-60	609.00	78.6
0-80	758.60	97.9
0-90	775.05	100.0
10-90	749.68	96.7
20-40	246.54	31.8
20-50	386.22	49.8
40-70	358.24	46.2
60-80	149.61	19.3
70-80	55.54	7.2
80-90	16.45	2.1
0-180	775.05	100.0

#### 6" Round LRXE

**3500K**

1150 LM

LRXER6119SWRMT

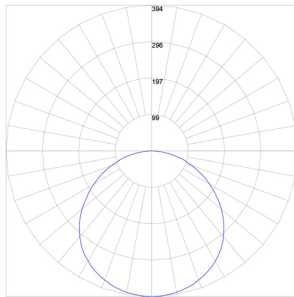

Maximum Candela = 384.2. Located At Horizontal Angle = 0, Vertical Angle = 0  
Vertical Plane Through Horizontal Angles (0 - 180) (Through Max. Cd.)

ZONE	LUMENS
0-10	37.37
10-20	107.88
20-30	165.97
30-40	203.61
40-50	212.69
50-60	191.29
60-70	147.12
70-80	88.59
80-90	27.77

ZONE	LUMENS	% OF FIXTURE
0-20	145.25	12.3
0-30	311.23	26.3
0-40	514.83	43.5
0-60	918.82	77.7
0-80	1154.53	97.7
0-90	1182.30	100.0
10-90	1144.93	96.8
20-40	369.58	31.3
20-50	582.27	49.2
40-70	551.11	46.6
60-80	235.71	19.9
70-80	88.59	7.5
80-90	27.77	2.3
0-180	1182.30	100.0

#### 8" Round LRXE

**3500K**

1800 LM

LRXER8189SWRMT

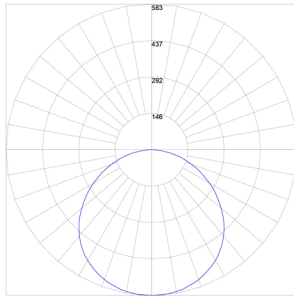

Maximum Candela = 583.2. Located At Horizontal Angle = 0, Vertical Angle = 0  
Vertical Plane Through Horizontal Angles (0 - 180) (Through Max. Cd.)

ZONE	LUMENS
0-10	55.38
10-20	160.08
20-30	246.52
30-40	302.60
40-50	315.99
50-60	283.93
60-70	217.67
70-80	130.17
80-90	40.85

ZONE	LUMENS	% OF FIXTURE
0-20	215.46	12.3
0-30	461.97	26.4
0-40	764.57	43.6
0-60	1364.48	77.8
0-80	1712.33	97.7
0-90	1753.17	100.0
10-90	1697.79	96.8
20-40	549.11	31.3
20-50	865.10	49.3
40-70	817.58	46.6
60-80	347.85	19.8
70-80	130.17	7.4
80-90	40.85	2.3
0-180	1753.17	100.0

### Photometric Data

#### 4" Square LRXE

3500K

750 LM

LRXES4079SWRMT

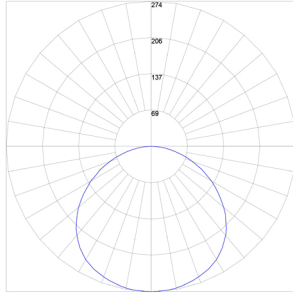

ZONE	LUMENS
0-10	26.08
10-20	75.75
20-30	118.02
30-40	146.54
40-50	154.41
50-60	139.12
60-70	105.96
70-80	62.80
80-90	18.51

ZONE	LUMENS	% OF FIXTURE
0-20	101.83	12.0
0-30	219.85	26.0
0-40	366.39	43.2
0-60	659.92	77.9
0-80	828.68	97.8
0-90	847.19	100.0
10-90	821.12	96.9
20-40	264.56	31.2
20-50	418.97	49.5
40-70	399.49	47.2
60-80	168.76	19.9
70-80	62.80	7.4
80-90	18.51	2.2
0-180	847.19	100.0

#### 6" Square LRXE

3500K

1150 LM

LRXES6119SWRMT

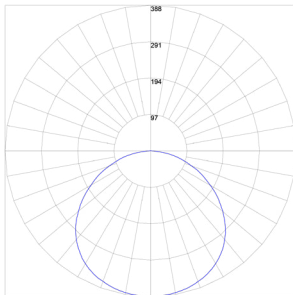

ZONE	LUMENS
0-10	36.82
10-20	106.89
20-30	166.27
30-40	206.11
40-50	217.07
50-60	195.64
60-70	149.52
70-80	88.87
80-90	26.74

ZONE	LUMENS	% OF FIXTURE
0-20	143.70	12.0
0-30	309.97	26.0
0-40	516.09	43.2
0-60	928.79	77.8
0-80	1167.18	97.8
0-90	1193.92	100.0
10-90	1157.10	96.9
20-40	372.38	31.2
20-50	589.45	49.4
40-70	562.22	47.1
60-80	238.39	20.0
70-80	88.87	7.4
80-90	26.74	2.2
0-180	1193.92	100.0

#### 8" Square LRXE

3500K

1800 LM

LRXES8189SWRMT

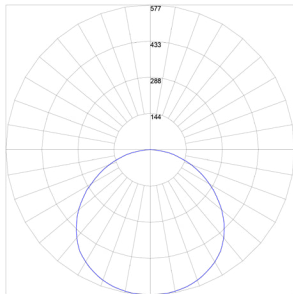

ZONE	LUMENS
0-10	54.84
10-20	159.30
20-30	247.21
30-40	306.12
40-50	321.33
50-60	289.35
60-70	221.81
70-80	132.45
80-90	41.29

ZONE	LUMENS	% OF FIXTURE
0-20	214.12	12.1
0-30	461.34	26.0
0-40	767.46	43.3
0-60	1378.15	77.7
0-80	1732.41	97.7
0-90	1773.70	100.0
10-90	1718.86	96.9
20-40	553.33	31.2
20-50	874.66	49.3
40-70	832.50	46.9
60-80	354.26	20
70-80	132.45	7.5
80-90	41.29	2.3
0-180	1773.70	100

**CUSTOMER NAME**

Project Name \_\_\_\_\_

Date \_\_\_\_\_ Type \_\_\_\_\_

Catalog Number \_\_\_\_\_

## Dimmer Compatibility List

### Important Notice

Because dimming equipment, applications, and conditions of use are many, varied, and beyond Current's control, this information necessarily is based on limited samples sizes and testing. This list only included dimmers that have been tested with the Current's luminaires listed. There may be other dimmers on the market that are compatible with these Current's luminaires. If you have a question about a particular dimmer that is not on the list, please contact Current to see if the model has been tested, or to arrange testing.

### Triac/ELV Dimming

1. Adjust the dimmer to the lowest setting.
2. Locate the trim adjustment and set the lowest light level where the light output is stable.
3. Turn fixture off and on to ensure proper operation. If it is not operating as expected, adjust the trim up slightly and retest.

### 0-10V Dimming

1. Turn the fixture on.
2. Adjust the dimmer to the lowest setting.
3. Adjust trim down until all fixtures appear to be off.

DIMMER BRAND	MODEL NUMBER	DIMMER TYPE
Current	RSD 710-UNV	0-10V
Current	PSD 710-UNV	
Lutron	Diva® DVTC	
Lutron	Nova T NTFTV	
Leviton	IllumaTech IP710	ELV
Current	RSD E06-120	
Lutron	Diva® DVELV-300P	
Lutron	Nova T NTELC-300	
Leviton	Decora® 6615-P	Triac
Current	RSD L06-120	
Lutron	Skylark S-600	
Lutron	Maestro® MA-600I	
Leviton	Decora® 6672-1LW	