

Cuisinart® for



INSTRUCTION/RECIPE BOOKLET



IPERESPRESSO 

**Buona Tazza™ Single Serve Espresso,
Caffe Latte and Cappuccino Machine**

EM-350 SERIES

For your safety and continued enjoyment of this product, always read the instruction book carefully before using.

IMPORTANT SAFEGUARDS

We at Cuisinart are very safety conscious. We design and manufacture consumer products with the safety of you, our valued customer, foremost in mind. In addition we ask that you exercise a degree of care when using electrical appliances and adhere to the following precautions.

When using electrical appliances, basic safety precautions should always be followed, including the following:

- CAREFULLY READ ALL INSTRUCTIONS BEFORE OPERATING APPLIANCE, AND SAVE THIS MANUAL FOR FUTURE REFERENCE.**
- Unplug appliance from outlet when not in use and before cleaning. Allow to cool before putting on or taking off parts, and before cleaning.**
- To protect against fire, electric shock and injury to persons do not immerse the appliance, cord or plug in water or any other liquid.
- This appliance is for household use only.
- Do not operate the unit with the brewing head open.
- Do not use this appliance for anything other than its intended use.
- This appliance should not be used by or near children or individuals with certain disabilities.
- Do not leave the appliance unattended when in use.
- Do not touch hot surfaces. Use handles or knobs.
- Always use the appliance on a dry, level surface.
- To disconnect, turn all controls off, then remove plug from power outlet.
- Do not place this appliance on or near a hot gas or electric burner, or where it could touch a heated oven.
- Do not let the cord hang over the edge of a table or counter or touch hot surfaces or become knotted.
- The use of accessory attachments not recommended by Cuisinart may cause a risk of injury to persons, fire or electrical shock.
- Strictly follow cleaning and care instructions.
- Do not use this appliance for anything other than its intended use. Do not use in moving vehicles or boats.
- Do not use outdoors.
- Always switch the appliance off and then remove plug from the power outlet when the appliance is not being used and before cleaning.
- An extension cord is not recommended. However, if one is needed, the extension cord should be a grounded type and its electrical rating must be the same or higher wattage as the appliance. Regularly inspect the supply cord, plug and actual appliance for any damage. If found damaged in any way, immediately cease use of the appliance and call Cuisinart Customer Service at 1-800-726-0190.
- For any maintenance other than cleaning, call Cuisinart Customer Service at 1-800-726-0190.
- Refer servicing to qualified personnel.
- Do not operate any appliance with a damaged cord or plug or after the appliance malfunctions, or has been damaged in any manner. Return appliance to the nearest authorized service facility for examination, repair or adjustment.
- Do not operate your appliance in an appliance garage or under a wall cabinet. **When storing in an appliance garage always unplug the unit from the electrical outlet.** Not doing so could create a risk of fire, especially if the appliance touches the walls of the garage or the door touches the unit as it closes.
- Scalding may occur if the brewing head is opened during brewing cycle.

SAVE THESE INSTRUCTIONS FOR HOUSEHOLD USE ONLY

WARNING: RISK OF FIRE OR ELECTRIC SHOCK



The lightning flash with arrowhead symbol within an equilateral triangle is intended to alert the user to the presence of uninsulated dangerous voltage within the product's enclosure that may be of sufficient magnitude to constitute a risk of fire or electric shock to persons. The exclamation point within an equilateral triangle is intended to alert the user to the presence of important operating and maintenance (servicing) instructions in the literature accompanying the appliance.



WARNING
RISK OF FIRE OR ELECTRIC SHOCK
DO NOT OPEN

WARNING: TO REDUCE THE RISK OF FIRE OR ELECTRIC SHOCK,
DO NOT REMOVE COVER (OR BACK)
NO USER-SERVICEABLE PARTS INSIDE
REPAIR SHOULD BE DONE BY AUTHORIZED SERVICE PERSONNEL ONLY

NOTE: For safety reasons it is recommended you plug your Cuisinart appliance directly into the power outlet. Use in conjunction with a power strip or extension cord is not recommended.

SPECIAL CORD SET INSTRUCTIONS

A short power-supply cord is provided to reduce the risks resulting from becoming entangled in or tripping over a longer cord.

Longer extension cords are available and may be used if care is exercised in their use.

If an extension cord is used, the marked electrical rating of the extension cord must be at least as great as the electrical rating of the appliance. The extension cord should be a grounding-type 3-wire cord, and the longer cord should be arranged so that it will not drape over the countertop or tabletop where it can be pulled on by children or tripped over.

NOTICE

If you have a die-cast metal unit, for your protection it is equipped with a 3-conductor cord set that has a molded 3-prong grounding-type plug, and should be used in combination with a properly connected grounding-type outlet as shown in Figure A.

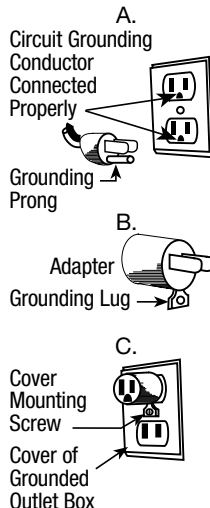

SPECIAL SAFETY INSTRUCTIONS

1. Use only cold water in the water reservoir. Do not use any other liquid.
2. Never use the machine without water in it.

If a grounding-type outlet is not available, an adapter, as shown in Figure B, may be obtained so that a 2-slot wall outlet can be used with a 3-prong plug. As shown in Figure C, the adapter must be grounded by

attaching its grounding lug under the screw of the outlet cover plate. **NOTE: Do not remove the grounding prong.**

CAUTION: Before using an adapter, it must be determined that the outlet cover plate screw is properly grounded. If in doubt, consult a licensed electrician. Never use an adapter unless you are sure it is properly grounded.

Note: Use of an adapter is not permitted in Canada.

CONTENTS

Important Safeguards.....	2
Unpacking Instructions	4
Introduction	4
Features and Benefits	5
Preparing Your Espresso Machine	6
Using Your Espresso Machine	6
Programming.....	7
Using the Steam Wand	7
Temperature Controls.....	8
Cleaning and Maintenance	8
Troubleshooting.....	9
Recipes.....	10
Steaming/Frothing Instructions.....	10
Warranty	17

IMPORTANT UNPACKING INSTRUCTIONS



1. Place the box on a large, sturdy, flat surface.
2. Remove the instruction book and any other literature.
3. Remove the sample pack of illy® iperEspresso® capsules.
4. Turn the box so that the backside of the machine is down, and slide the espresso maker from the box.
5. After the espresso maker has been removed, place the box and the side pulp-molded inserts out of the way.
6. Remove all packing materials, tape, etc.



We suggest you save all packing materials in the event that future shipping of the machine is needed. Keep all plastic bags away from children.

INTRODUCTION

Cuisinart and illy are proud to introduce the Buona Tazza™ Single Serve Espresso, Cappuccino and Latte Machine powered by Cuisinart and featuring the proprietary illy® iperEspresso® capsule system. This combines Cuisinart's excellence in coffeemakers and illy's legendary coffee heritage to bring the pleasure of savoring the rich, smooth taste of illy® to the comfort of your own home.

FEATURES AND BENEFITS

1. **Water Reservoir Lid**
2. **Removable 34-ounce Water Reservoir**
3. **Cup-Warming Plate**
Convenient place to warm cups.
4. **19 Bar Pump (not shown)**
5. **Brew Head Lever**
Use the die-cast metal lever to open and close the brew head.
6. **Brew Head**
7. **Brewing Spout**
Strategically positioned for optimal results.
8. **Used Capsule Container**
(Also contains some residual liquid left after brewing.)
9. **Espresso Cup Tray**
Folds up when taller mugs need to be used.
10. **Drip Tray Grate**
11. **Removable Drip Tray**
12. **Travel Mug Tray**
13. **Power Switch**
14. **Short Espresso Button** 
15. **Long Espresso Button** 
16. **Manual/Adjustable Strength Control/Programmable Button M**
17. **Steam Button** 
Used to make cappuccinos and lattes.
Will flash until ready for use.

18. **Stainless Steel Frothing Pitcher**
Used for steaming milk for cappuccinos and lattes.
19. **Frothing Wand and Removable Sleeve**
Used to steam milk for Cappuccinos and Lattes.
20. **Steam/Hot Water Control Dial**
Used to activate steam or hot water.
21. **Hot Setting Button** 
Select if less-hot coffee temperature is desired.
22. **Hotter Setting Button** 
Default coffee temperature setting.
23. **Energy Saver Mode (not shown)**
Saves 50% of power after 30 min. non-use.
24. **Auto Off Mode (not shown)**
Shuts off after 60 min. non-use.
25. **Power Cord (not shown)**
26. **Cleaning Pin**
Use the black cleaning pin to clean any excess milk that gets stuck inside the steam wand.
27. **BPA Free (not shown)**
All materials that come in contact with liquid are BPA free.
28. **14-Capsule Pack (not shown)**
Choose from 100% Arabica varieties!

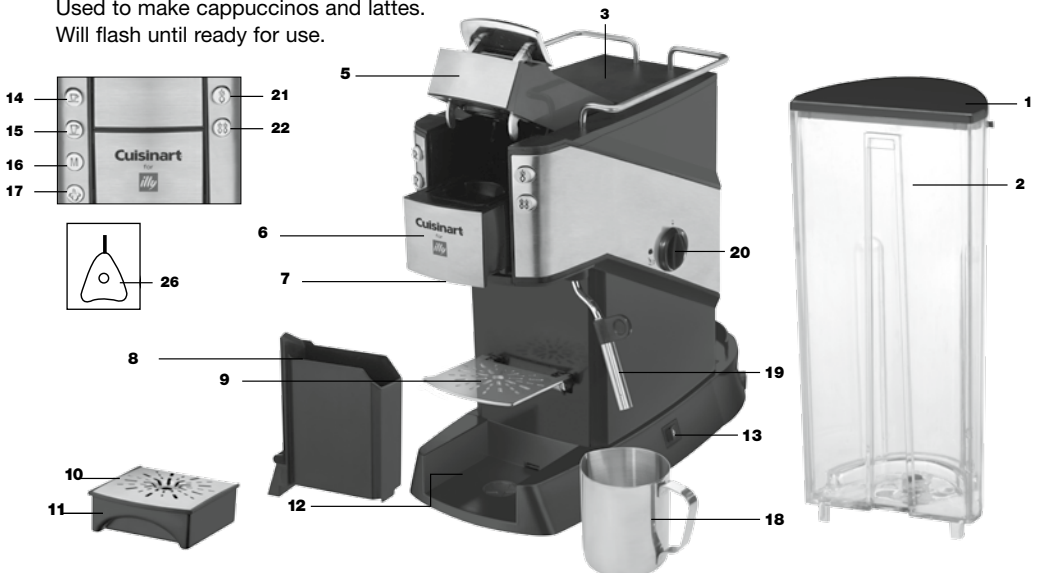

PREPARING YOUR ESPRESSO MACHINE

1. Put the espresso machine on a dry, stable countertop or other flat, sturdy surface where you will be using the machine.

IMPORTANT: For first-time use or if the machine has not been used for some time, it is important that it is rinsed as follows:

2. Remove the lid of the water reservoir. Using the handle, lift the water reservoir off the base and fill with fresh, cold drinking water. Replace the water reservoir on the base, and cover with the lid. Using the tracks as a guide, slide the water reservoir back into position and push down firmly to engage.

Important: The unit will not function unless the water reservoir is properly in place.

3. Insert the plug into a power outlet. Press the power button once to turn the espresso machine on. All of the controls on the front of the machine will flash while it's pre-heating. Lights will turn steady when the unit is in ready mode (approximately 1 minute).
4. Make sure the drip tray and grate are in place.
5. Place a mug on the drip tray.
6. Press the Manual **M** button and allow the water to run through for approximately 5 to 10 seconds. Press once more to stop.
7. Position espresso cups on the warming plate.
8. The machine is now in preheat/ready mode and ready to use.

NOTE: If the water reservoir is empty or not properly positioned, the unit will not function. The Short **V**, Long **V**, Manual **M** and Steam **S** LEDs will flash. Turn off the machine, fill the water reservoir, and turn the machine back on.

USING YOUR ESPRESSO MACHINE

Always make sure you have water in the reservoir, a capsule in the brew head, and that the appropriate tray is being used.

NOTE: This machine is designed

exclusively for use with illy® iperEspresso® capsules. No other type of capsule, pod, or coffee can be used.

Short or Long Pre-Programmed Espresso

1. Using the lever, open the brew head, insert a capsule, and close the brew head.



2. With an espresso cup on the espresso cup tray, select either a SHORT **V** (1.2 ounces) or LONG **V** (3 ounces) espresso. (The selected function and Hotter Temperature setting LEDs remain on, while all the other LEDs are off. Once all LEDs are on again, the machine is ready for the next cycle.)

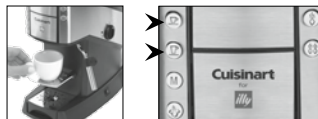

For optimal results, we recommend using the Long **V** button with the blue "Lungo" iperEspresso capsule. The Long **V** button provides an Americano single espresso. Using this setting with other iperEspresso® varieties will alter the taste.

NOTE: As part of illy-patented technology in the iperEspresso® capsule, the brewing process is completely self-contained in the capsule and does not get into the brew head. So there is no need to rinse in between cycles as there will be no transfer of flavor.

CAUTION: Scalding may occur if the brewing head is opened during brewing cycle.

Manual/Adjustable Strength Control Programming

1. Using the lever, open the brew head, insert a capsule, and close the brew head.



- For adjustable strength control, use the MANUAL **M** button to adjust the length of time espresso is dispensing – the longer you allow it to flow, the lighter it will be.



Press **M** to start dispensing. When your cup is filled to desired level, press **M** again to stop.

PROGRAMMING A CUSTOM SETTING

At ready mode, press and hold MANUAL **M** for 3 seconds to customize the SHORT **S** and LONG **L** output.



- S**, **L**, **M** are ON. If no action within 30 seconds, unit returns to preheat/ready mode.
- Press **S** or **L** button.
 - S** or **L** and **M** LED remain on.
 - Espresso is dispensed.
 - When desired amount is dispensed into cup, press **S** or **L** again. That will be the programmed amount.
 - If no action during dispensing within 90 seconds, the unit will return to preheat/ready mode.



To reset to factory setting at ready mode, press and hold **M** and **S** at the same time for 3 seconds.

- S**, and **L** and **M** LEDs flash 3 times.
- Default setting is on and unit will return to preheat/ready mode.

USING THE STEAM WAND

Milk frothing is the steaming of milk. The steam does two things; it heats the milk and mixes air with the milk to form a foamy texture. As with learning to make an espresso, perfecting the art of milk texturing takes time and practice.

- Determine how much milk is needed based on the number of cups being made. **TIP:** A minimum of 1½ ounces (3 tablespoons) and a maximum of 4 ounces (½ cup) can be frothed at one time. If only steaming the milk and not frothing, you may use up to 6 ounces (¾ cup).
- Pour cold refrigerated milk into the stainless frothing pitcher.
- Purge the steam wand of any water. With the steam wand positioned over the drip tray, activate the steam function by pressing the STEAM **W**. When light stops flashing turn STEAM control dial fully on. Once water has been purged, turn the control dial back to stop the steam.
- Swing the steam wand to the side of the espresso machine.
- Place the steam wand into the milk so that the nozzle is about a half-inch below the surface.
- Activate the steam function by first pressing the Steam **W** button. When light stops flashing, turn the STEAM control dial to steam position. This will start to create a whirlpool action in the milk. Once the milk begins to steam, bring the nozzle closer to the top of the milk to begin frothing.

It is recommended that you do not exceed 2 minutes of continuous steaming.

- As the steam heats and textures the milk, the level of the milk in the pitcher will begin to rise. As this happens, follow the level of the milk by lowering the pitcher, always keeping the tip of the steam nozzle just below the surface.



NOTE: Do not allow the steam to spurt unevenly or it will create aerated froth/ large bubbles. If this is happening, raise the pitcher so that the steam nozzle is lowered farther into the milk. Smaller bubbles are more stable than the larger ones, therefore making a tighter, longer-lasting froth.

- If you do not need foam, but only steamed milk, lower the steam nozzle further into the milk to prevent excess foam from forming. Move the pitcher in a circular motion so wand is not steaming in one place.
- Stop the steam immediately by turning the STEAM control dial to the closed position.
- Remove the pitcher, immediately wipe the steam nozzle and wand with a clean damp cloth and purge a small amount of steam.

USING THE HOT WATER FUNCTION

- Place the cup or container under the steam/hot water nozzle and activate the hot water function  by turning the steam and hot water control dial to the hot water setting.
- Once you have dispensed the required amount of hot water into the cup or container, stop the hot water by turning the steam/hot water control dial to the 0 position.
- Remove the cup or container and swing the steam/hot water wand over the drip tray to catch any drips of water.

TEMPERATURE CONTROLS

Hotter  is the default setting. If Hot is desired, press the  button and allow a few seconds for the temperature to decrease. The flashing light will turn steady when it has reached temperature.

NOTE: When the machine shuts off, and is turned back on, the last temperature setting used will be illuminated.

Energy Saver Mode

After 30 minutes of non-use the espresso machine will automatically switch to sleep mode and all the control lights will be dimmed by about 50%. When any button is pressed, the espresso machine will return to preheat mode and all the lights will flash.

The machine is ready to operate when all the lights are steady again.

Auto-Off Mode

Following the 30-minute Energy Saver cycle, if there is an additional 30 minutes of non-use, the espresso machine will turn off. Press the power button to turn on again.



CLEANING AND MAINTENANCE

Cleaning External Parts

We recommend regular cleaning of the espresso maker's external components.

- Never immerse the machine in water or other liquids. The housing and external parts may be cleaned with a soapy, damp, non-abrasive cloth.
- To remove the drip tray, simply slide it toward you, keeping it level at all times in order to prevent spills. The drip tray and drip tray grate are dishwasher safe. Do not clean drip tray with cleansers, steel wool pads or other abrasive materials.

Cleaning the Water Reservoir

It is normal over time for discoloration, spotting or staining to appear in the water reservoir. Results will vary depending on the mineral content of the bottled or filtered water used but will not affect the operation of the machine. However, be sure to clean the water reservoir regularly to minimize build-up.

Clean inside the water reservoir with a damp, lint-free cloth as necessary.

Cleaning The Steam Wand

- The steam wand should always be cleaned after steaming milk. Remove the stainless steel part and clean both thoroughly.
- Wipe the steam wand with a damp cloth, then with the steam wand directed back into the drip tray, press the STEAM  button and turn STEAM control dial. This

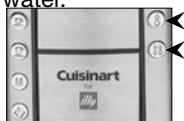

will release any remaining milk from inside the steam wand. Stop the steam immediately after by turning the STEAM control dial again.

3. Turn the power button to OFF, unplug the power cord and allow the machine to cool.

Decalcification

Mineral content in water varies from place to place. Depending on the mineral content of the water in your area, calcium deposits or scale may build up in your machine. Though scale is non-toxic, it can hinder performance. De-scaling the machine will help maintain the heating element and other parts that come in contact with water.

For optimal performance, de-scale your machine every 3 to 6 months. It is possible for calcium to build up faster, making it necessary to de-scale more often.

To begin, you will need the following:

- 10 ounces of distilled white vinegar
- 12-ounce ceramic mug (do not use paper cup)
- Access to sink

Step 1: First Vinegar Rinse

- Fill water reservoir with 10 ounces of undiluted white vinegar.
- Place the ceramic mug on the drip tray.
- Lift the brew head handle, but do NOT add a capsule.
- Close the brew head and press the Manual **M** button.
- **M** will illuminate blue while the vinegar is dispensing. Press **M** again to stop it once the mug is halfway full.
- Allow the machine to sit for 30 minutes.
- Power on the machine, open and close the brew head, then press **M** to start dispensing. Press **M** again to stop dispensing. Position frothing wand into mug. Press the STEAM  button. When light stops flashing, turn the Steam Control Dial to the STEAM position to dispense steam for a few seconds. Turn steam control dial to the off position.
- Discard the contents of the mug into the sink.

Step 2: Fresh Water Rinse

- Repeat step 1 three times using fresh water in place of vinegar.
- This will clean the machine's plumbing and remove any residual vinegar taste. The machine is now ready for normal use.

Maintenance: Any other servicing should be performed by an authorized service representative.

TROUBLESHOOTING

Problem: Machine does not have power.

Solution:

- Plug the machine into an independent outlet.
- Make sure the machine is securely plugged in.
- Reset your home's circuit breaker.
- Confirm the power has been turned on and the controls are illuminated.

Problem: Machine will not brew.

Solution:

- Turn off and unplug the machine for 30 seconds or more. When you plug the machine back in, be sure to turn the power back on.
- Make sure there is water in the reservoir.
- Make sure the reservoir is properly installed.
- Make sure brew head is completely closed.

Problem: Chlorine or mineral taste in coffee.

Solution:

- Consider using bottled or filtered water.

Problem: Machine doesn't brew a full cup.

Solution:

- Turn off and unplug the machine for 30 seconds or more. When you plug the machine back in, be sure to turn the power back on.
- Decalcify the machine (refer Decalcification, this page).

Problem: The used capsule will not fall into the capsule container.

Solution:

- That indicates the capsule container is full. Empty the capsule container and then try again, or manually remove the used capsule in the brew head.

Problem: I want to reset the coffee programming.

Solution:

- See page 7 for instructions.

Problem: Manual/Steam  buttons flash.

Solution:

- The steam control dial is in the wrong position. Turn it back to the "0" position and power the machine off, and on again to reset.

Problem: The control lights are not as bright as they were.

Solution:

- The machine has an energy-saving feature that dims the lights and power by about 50% after 30 minutes of non-use. Restore full power by pressing any button.

Problem: Machine turned off.

Solution:

- The machine's auto-off feature turns the coffeemaker off after 60 minutes of non-use.

Problem: Coffee is too hot.



Solution:

- Press the **HOT ** button and wait until the light is steady.

Problem: Coffee is not hot enough.

Solution:

- Press the **HOTTER SETTING ** button and wait until the light is steady.
- If still not hot enough at hotter setting: with no capsule in the brew head, use the Manual **M** button to dispense a cup of water to preheat, then make your espresso as indicated on page 6.

Problem: SHORT  /LONG  buttons flash quickly; all buttons are non-functional; or some buttons are off.

Solution:

- Indicates the coffee boiler has short-circuited or detects low temperature. Recover the unit by unplugging it and let the unit cool down for approximately 10 minutes.

Problem: Short  /Long  /

Manual/Steam  buttons flash.

Solution:

- Refill the water reservoir or make sure it is properly engaged on the base.

Problem: Machine shuts off (not related to auto shutoff).

Solution:

- Brew head must be closed during coffee brewing and milk frothing.

RECIPES

Steaming/Frothing Instructions	11
Espresso Macchiato	11
Espresso Breve	11
Cappuccino	12
Café Latte	12
Soy Latte	12
Flavored Latte	12
Mochaccino	13
Caffè Mocha	13
Ice Cappuccino	13
Frozen Latte	14
Espresso Shake	14
Espresso Martini	14
Caffè Coretto	14
Granita	15
Affogato	15
Espresso Gelato	15
Tiramisù	16
Ham Steak with Red-Eye Gravy	16
Espresso-Marinated Flank Steak	17

Steaming/Frothing Instructions

When steaming milk for delicious coffee-based drinks, always start with fresh, cold milk and steam only what you are going to use right away. For best results, we prefer using non-fat or skim milk, which produces light, voluminous foam, but feel free to experiment. Keep in mind that the consistency of the foam will vary depending on what type of milk is used. It is always best to froth your milk right before serving.

NOTE: When steaming milk to mix with espresso, insert capsule prior to steaming.



Espresso Macchiato

A simple spot of foam makes this drink a classic.

Makes 1 serving

1 **illy® iberEspresso® capsule**

3 **tablespoons cold skim milk**

1. Place an espresso cup on the espresso cup tray.
2. Using the lever, open the brew head, insert the capsule and close the brew head.
3. Put the milk into the stainless pitcher.
4. Press the Steam  Button. Once the button stops flashing, submerge the steam wand into the pitcher of milk and froth. Turn dial to stop frothing; reserve.
5. Press the Short  button to brew espresso. When the brewing process is complete, use a large spoon to place one tablespoon of the foam on top of the espresso. Serve immediately.



Espresso Breve

American version of a latte – substituting half & half for milk.

Makes 1 serving

1 **illy® iberEspresso® capsule**



¾ **cup cold half & half**

1. Place a mug on the latte/cappuccino tray.
2. Using the lever, open the brew head, insert the capsule and close the brew head.
3. Put the half & half into the stainless pitcher.
4. Press the Steam  Button. Once the button stops flashing, submerge the steam wand into the pitcher of half & half and steam. Keep the wand fully submerged to prevent excessive froth from forming. Turn dial to stop steaming; reserve.
5. Press the Short  button to brew the espresso. When the brewing process is complete, pour the steamed cream into the espresso and serve immediately.

Cappuccino

A thick layer of foam and bit of milk let the boldness of the coffee shine through in this popular drink.



Makes 1 serving

- 1 illy® iperEspresso® capsule**
- 3 tablespoons cold skim milk**
1. Place a mug on the latte/cappuccino tray.
2. Using the lever, open the brew head, insert the capsule and close the brew head.
3. Put the milk into the stainless pitcher.
4. Press the Steam  Button. Once the button stops flashing, submerge the steam wand into the pitcher of milk and steam. Gently use an up and down motion to keep wand submerged but slightly toward the top of the milk to produce a nice foam. Turn dial to stop frothing; reserve.
5. Press the Short  button to brew espresso. When the brewing process is complete, slowly pour the steamed milk, out of the side of the pitcher, into the espresso and then top with a thick layer of foam. Serve immediately.

Caffé Latte

Similar to a cappuccino, this drink contains more milk, which makes it creamy.

Makes 1 serving



- 1 illy® iperEspresso® capsule**
- ½ cup cold skim milk**
1. Put a mug on the latte/cappuccino tray.
2. Using the lever, open the brew head, insert the capsule and close the brew head.
3. Put the milk into the stainless pitcher.
4. Press the Steam  Button. Once the button stops flashing, submerge the steam wand into the pitcher of milk to steam. Gently use an up and down motion to keep wand submerged but slightly toward the top of the milk to produce a nice foam. Turn dial to stop steaming; reserve.
5. Press the Short  button to brew espresso.

6. When the brewing process is complete, slowly pour the steamed milk, out of the side of the pitcher, into the espresso. Top with enough foam to just cover and serve immediately.

Soy Latte

This is a delicious non-dairy alternative.

Makes 1 serving

- 1 illy® iperEspresso® capsule**
- ½ cup cold soy milk**
1. Put a mug on the latte/cappuccino tray.
2. Using the lever, open the brew head, insert the capsule and close the brew head.
3. Put the milk into the stainless pitcher.
4. Press the Steam  Button. Once the button stops flashing, submerge the steam wand into the pitcher of milk to steam. Gently use an up and down motion to keep wand submerged but slightly toward the top of the milk to produce a nice foam. Turn dial to stop steaming; reserve
5. Press the Short  button to brew espresso.
6. When the brewing process is complete, slowly pour the steamed milk, out of the side of the pitcher, into the espresso. Top with enough foam to just cover and serve immediately.

Flavored Latte

Any type of flavored syrup can be used in this recipe.

Makes 1 serving

- 1 tablespoon flavored syrup**
- 1 illy® iperEspresso® capsule**
- ½ cup cold skim milk**
1. Put the syrup into a mug and place on the latte/cappuccino tray.
2. Using the lever, open the brew head, insert the capsule and close the brew head.
3. Put the milk into the stainless pitcher.
4. Press the Steam  Button. Once the button stops flashing, submerge the steam wand into the pitcher of milk to steam.



Gently use an up and down motion to keep wand submerged but slightly toward the top of the milk to produce a nice foam. Turn dial to stop steaming; reserve.

5. Press the Short  button to brew espresso.
6. When the brewing process is complete, slowly pour the steamed milk, out of the side of the pitcher, into the espresso and lightly stir. Top with a bit of the foam and serve immediately.

Mochaccino

Chocolate cappuccino – what could be better?!



Makes 1 serving

- 2 tablespoons chocolate syrup**
 - 1 illy® iperEspresso® capsule**
 - 3 tablespoons cold skim milk**
 - 1 teaspoon shaved bittersweet chocolate or unsweetened cocoa powder (for garnish)**
1. Swirl half of the chocolate syrup around the inside of a mug and place on the latte/cappuccino tray.
 2. Using the lever, open the brew head, insert the capsule and close the brew head.
 3. Put the milk into the stainless pitcher.
 4. Press the Steam  Button. Once the button stops flashing, submerge the steam wand into the pitcher of milk and steam. Gently use an up and down motion to keep wand submerged but slightly toward the top of the milk to produce a nice foam. Turn dial to stop frothing; reserve.
 5. Press the Short  button to brew espresso. When brewing process is complete stir in the remaining chocolate syrup and slowly pour the steamed milk, out of the side of the pitcher, into the espresso. Top with a thick layer of foam and sprinkle with the shaved chocolate or cocoa. Serve immediately.

Caffè Mocha

This ultra-rich drink makes a perfect ending to any special meal.

Makes 1 serving

- 1 illy® iperEspresso® capsule**
 - 1/3 cup cold skim milk**
 - 1 tablespoon chocolate syrup**
 - 2 tablespoons whipped cream**
 - 1 teaspoon shaved bittersweet chocolate or unsweetened cocoa powder (for garnish)**
1. Put a mug on the latte/cappuccino tray.
 2. Using the lever, open the brew head, insert the capsule and close the brew head.
 3. Put the milk into the stainless pitcher.
 4. Press the Steam  Button. Once the button stops flashing, submerge the steam wand into the pitcher of milk and steam. Gently use an up and down motion to keep wand submerged but slightly toward the top of the milk to produce a nice foam. Turn dial to stop frothing; reserve.
 5. Press the Short  button to brew espresso. When brewing process is complete stir in the chocolate syrup. Slowly pour the steamed milk, out of the side of the pitcher, into the cup. Top with a small amount of foam and then with the whipped cream and chocolate or cocoa. Serve immediately.

Iced Cappuccino

Cool down during the warmer months with this refreshing drink.

Makes 1 serving

- 1 illy® iperEspresso® capsule**
 - 4 ice cubes**
 - 1/3 cup whole milk***
 - 3 tablespoons cold skim milk**
1. Using the lever, open the brew head, insert the capsule and close the brew head. Press the Short  button to brew espresso.
 2. When the brewing process is complete, set

the espresso aside and let cool to at least room temperature. Once cool, put the ice cubes and whole milk into a tall glass. Stir in the espresso.

- Put the skim milk in the stainless pitcher. Press the Steam  Button. Once the button stops flashing, submerge the steam wand into the pitcher of milk and froth. Gently use an up and down motion to keep wand submerged but slightly toward the top of the milk to produce a nice foam. Turn dial to stop frothing.



- Top the cappuccino with the foam and serve immediately.

*Skim milk can be used; however we like the extra richness the whole milk provides for this icy treat.

Frozen Latte

You will never need to go out for coffee when you can make this frosty treat at home.

Makes 3 cups

- 2 Lungo or Long illy® iperEspresso® capsules (equal to ¾ cup brewed espresso)**
 - ½ cup cold skim milk**
 - 2 tablespoons granulated sugar**
 - 6 heavy cream ice cubes***
 - 6 ice cubes**
- Put a mug on the latte/cappuccino tray.
 - Using the lever, open the brew head, insert the capsule and close the brew head. Press the Long  button to brew espresso. When the brewing process is complete, insert a new capsule into the brew head and press Long again.
 - Put the milk into the stainless pitcher. Press Steam  button. Once the button stops flashing, submerge the steam wand into the pitcher of milk and steam. Keep the wand fully submerged to prevent excessive froth from forming. Turn dial to stop steaming; reserve.
 - Stir milk and sugar into the espresso to dissolve; cool to at least room temperature.
 - Put cooled beverage, cream and regular

ice cubes in a Cuisinart® blender jar. Cover and blend on highest speed until smooth, about 1 minute.

- Serve immediately.

Note: For an iced mocha, add 2 tablespoons of chocolate syrup while blending.

*Pour heavy cream into ice cube trays and freeze overnight for heavy cream ice cubes.

Espresso Shake

Thick and delicious!

Makes about 3 cups

- 1 cup brewed espresso, chilled**

- 2 cups coffee ice cream**

- Put espresso and ice cream into a Cuisinart® blender jar. 2. Cover and blend on lowest speed until smooth, about 1 minute.

Espresso Martini

A delicious cocktail that packs a punch.

Makes 1½ cups, about three ½-cup servings

- 10 ice cubes**

- ½ cup vodka**

- ½ cup brewed espresso, chilled**

- 2 tablespoons Kahlua®**

- 2 tablespoons Tia Maria® espresso beans for garnish**

- Put the ice cubes, vodka, espresso, Kahlua® and Tia Maria® into a cocktail shaker. Shake really well until fully mixed and chilled.
- Pour equally into 3 martini glasses.
- Add an espresso bean or two in each glass for garnish and serve immediately.

Kahlua® is a registered trademark of the Absolut Company AKTiebolag.

Tia Maria® is a registered trademark of Ilva Saronno S.P.A.

Caffè Coretto

The perfect closer.

Makes 1 serving

- 2 illy® iverEspresso® capsules**
- 1 ounce sambuca**
- 1. Put an espresso cup on the espresso cup tray.
- 2. Using the lever, open the brew head, insert one capsule, close the brew head and press the Short **VP** button. Repeat with the second capsule.
- 3. Pour the sambuca into a brandy snifter.
- 3. Pour espresso into sambuca and serve before drinking.

Granita

A light and simple dessert.

Makes 4 servings

- 1½ cups brewed espresso, chilled**
- 2 tablespoons granulated sugar**
- 1 cup whipped cream**
- 1 teaspoon shaved bittersweet or semisweet chocolate for garnish**
- 1. Put a tall 16-ounce glass on the latte/cappuccino or travel cup tray. Using the lever, open the brew head, insert the capsule and close the brew head. Press the Long **VP** button to brew espresso. Repeat with remaining capsules.
- 2. Stir sugar into the hot espresso to dissolve and pour mixture into a freezer-safe container. Leave to cool to room temperature.
- 3. Once cool, cover with plastic wrap and place in the freezer. Every hour, for about 5 hours total, scrape the mixture with a fork to allow crystals to form.
- 4. To serve, layer equal amounts of granita and whipped cream in a parfait glass. Garnish with shaved chocolate.

Affogato

Dessert for two. Scoop your ice cream in advance and save in the freezer until ready to serve.

- 2 scoops vanilla ice cream**
- 2 illy® iverEspresso® capsules**
- 1. Scoop ice cream into two individual bowls. Put an espresso cup on the espresso cup tray. Have an additional espresso cup ready.
- 2. Using the lever, open the brew head, insert the capsule, close the brew head and press the Short **VP** button to brew espresso.
- 3. When the brewing process is complete, repeat. Pour each espresso over the ice cream and serve immediately.

Espresso Gelato

For an extra jolt, add some dark chocolate-covered espresso beans toward the end of freezing.

Makes about 4 cups (eight ½-cup servings)

- 1 cup heavy cream**
- 2 cups whole milk, divided**
- 1 cup brewed espresso**
- 1 cup granulated sugar**
- 2 tablespoons cornstarch**
- pinch kosher salt**
- 1 tablespoon liquid pectin**
- 1. In a medium saucepan, combine cream and 1½ cups of the milk. Set over medium/medium-low heat and bring to a simmer.
- 2. While cream/milk mixture is heating, put the remaining milk, espresso, sugar, cornstarch and salt into a small/medium mixing bowl. Whisk to combine.
- 3. Once milk/cream mixture comes to a simmer, add the milk/sugar mixture and stir until fully combined. While still set over medium/medium-low heat, stir continuously until mixture boils and thickens so that it can coat the back of a spoon (this will take about 15 minutes,

- depending on the stove being used).
- Remove pan from heat, stir in pectin, strain and cool to room temperature. Cover and refrigerate overnight.
 - Whisk mixture together again before pouring into the ice cream maker. Pour the mixture into the mixing bowl of the Cuisinart® Ice Cream Maker. Mix until thickened, about 30 minutes. The gelato will have a soft, creamy texture. If a firmer consistency is desired, transfer to an airtight container and place in freezer for about 2 hours. Remove from freezer about 15 minutes before serving.

Tiramisù

A simple variation of the Italian classic.

Makes 9 servings

- 1 container (8 ounces) mascarpone cheese, room temperature**
 - 1 cup chilled heavy cream**
 - ¼ cup plus 2 tablespoons confectioners' sugar**
 - 2 tablespoons plus 1 teaspoon dark rum, divided**
 - ½ cups brewed espresso, cooled**
 - 28 Savoiardi (crisp Italian ladyfingers)**
 - ¼ cup unsweetened cocoa powder, for garnish**
- Beat the mascarpone in a medium bowl using a Cuisinart® hand mixer until lightened and slightly whipped. In another bowl, whip the heavy cream to soft peaks, adding the confectioners' sugar a little at a time while whipping. Add 1 teaspoon of the rum and whip briefly to incorporate. Gently fold the whipped cream into the mascarpone, ⅓ at a time, until completely incorporated.
 - In a shallow bowl, mix the espresso with the remaining 2 tablespoons of rum. Working with one ladyfinger at a time, dip the cookie into the espresso, soaking each side for a few seconds, and transfer to 9-inch square baking pan or dish. Repeat with 13 more of the ladyfingers, arranging

- in the bottom of the dish to cover the entire surface. It should be a tight fit.
- Evenly spread half of the mascarpone cream over the ladyfingers, covering the entire surface. Dip the remaining ladyfingers and arrange over the cream. Spread an even layer of the remaining mascarpone mixture on top. Cover with plastic wrap and chill for at least 6 hours.
- Before serving, pour the cocoa powder into a small strainer and dust over the top of the tiramisù.

Ham Steak with Red-Eye Gravy

A twist on the Southern breakfast staple.

Serve alongside biscuits and grits.

Makes 2 servings

- 1 teaspoon canola or grapeseed oil**
 - 1 7-ounce smoked ham steak, ¼-inch thick**
 - ½ cup brewed espresso**
 - 1 teaspoon granulated sugar**
 - 1 tablespoon unsalted butter, chilled**
- Put the oil into a 10-inch skillet and place over medium-high heat. Once the oil is hot and shimmers, add the ham steak. Cook until browned, about 5 to 6 minutes per side. Remove ham to a plate and set aside.
 - Add the coffee to the skillet and stir with a wooden spoon, scraping up any bits on the bottom of the pan. Stir in the sugar to dissolve. Simmer the coffee until it has reduced by about ⅓ to ½. Right before taking the pan off the heat, swirl in the butter until incorporated. Remove the pan from the heat.
 - Slice the steak in half and spoon gravy over the top or serve on the side.

Espresso-Marinated Flank Steak

Espresso becomes the star in this easy-to-prepare marinade.

Makes 4 servings

- 1 cup brewed espresso, cooled**
 - 2 tablespoons molasses**
 - 2 tablespoons fresh lemon juice**
 - 1 tablespoon apple cider vinegar**
 - ¼ teaspoon ground black pepper**
 - ¼ teaspoon crushed red pepper**
 - 1 pound flank steak**
 - 1 teaspoon kosher salt**
1. Whisk together the espresso, molasses, lemon juice, apple cider vinegar and both peppers in a bowl. Add the flank steak and make sure it is submerged in the marinade. Refrigerate overnight.
 2. Preheat a Cuisinart® Griddler fitted with grill plates in the open position to Sear. When grill is ready, remove as much excess marinade as possible and season with the salt. Grill about 5 to 6 minutes per side for medium rare.
 3. Let steak rest for 5 minutes before slicing and serving.

FULL TWO-YEAR WARRANTY

This warranty is available to consumers only. You are a consumer if you own a Buona Tazza™ Single Serve Espresso, Cappuccino and Latte Machine that was purchased at retail for personal, family or household use. Except as otherwise required under applicable law, this warranty is not available to retailers or other commercial purchasers or owners. We warrant that your Buona Tazza™ Single Serve Espresso, Cappuccino and Latte Machine will be free of defects in materials and workmanship under normal home use for 2 years from the date of original purchase.

We recommend that you visit our website, www.cuisinart.com for a fast, efficient way to complete your product registration. However, product registration does not eliminate the need for the consumer to maintain the original proof of purchase in order to obtain the warranty benefits. In the event that you do not have proof of purchase date, the purchase date for purposes of this warranty will be the date of manufacture.

California Residents Only

California law provides that for In-Warranty Service, California residents have the option of returning a nonconforming product (A) to the store where it was purchased or (B) to another retail store that sells Cuisinart products of the same type. The retail store shall then, according to its preference, either repair the product, refer the consumer to an independent repair facility, replace the product, or refund the purchase price less the amount directly attributable to the consumer's prior usage of the product. If the above two options do not result in the appropriate relief to the consumer, the consumer may then take the product to an independent repair facility, if service or repair can be economically accomplished. Cuisinart and not the consumer will be responsible for the reasonable cost of such service, repair, replacement, or refund for nonconforming products under warranty. California residents may also, according to their preference, return nonconforming products directly to Cuisinart for repair or, if necessary, replacement by calling our Consumer Service Center toll-free at 1-800-726-0190. Cuisinart will be responsible for the cost of the repair, replacement, and shipping and handling for such nonconforming products under warranty.

BEFORE RETURNING YOUR CUISINART PRODUCT

If your Buona Tazza™ Single Serve Espresso, Cappuccino and Latte Machine should prove to be defective within the warranty period, we will repair or, if we think necessary, replace it. To obtain warranty service, please call our Consumer Service Center toll-free at 1-800-726-0190 or write to: Cuisinart, 7475 North Glen Harbor Blvd. Glendale, AZ 85307. To facilitate the speed and accuracy of your return, enclose \$10.00 for shipping and handling. (California residents need only supply a proof of purchase and should call 1-800-726-0190 for shipping instructions.) Be sure to include your return address, description of the product's defect, product serial number, and any other information pertinent to the return. Please pay by check or money order. **NOTE:** For added protection and secure handling of any Cuisinart product that is being returned, we recommend you use a traceable, insured delivery service. Cuisinart cannot be held responsible for in-transit damage or for packages that are not delivered to us. Lost and/or damaged products are not covered under warranty.

Your Buona Tazza™ Single Serve Espresso, Cappuccino and Latte Machine has been manufactured to the strictest specifications and has been designed for use only in 120 volt outlets and only with authorized accessories and replacement parts. This warranty expressly excludes any defects or damages caused by attempted use of this unit with a converter, as well as use with accessories, replacement parts or repair service other than those authorized by Cuisinart. This warranty does not cover any damage caused by accident, misuse, shipment or other than ordinary household use. This warranty excludes all incidental or consequential damages. Some states do not allow the exclusion or limitation of these damages, so these exclusions may not apply to you. You may also have other rights, which vary from state to state.

Important: If the nonconforming product is to be serviced by someone other than Cuisinart's Authorized Service Center, please remind the servicer to call our Consumer Service Center at 1-800-726-0190 to ensure that the problem is properly diagnosed, the product is serviced with the correct parts, and to ensure that the product is still under warranty.

Cuisinart®

SAVOR THE GOOD LIFE®



Food Processors



Juicers



Coffeemakers



Cookware



Tools and Gadgets

Cuisinart offers an extensive assortment of top quality products to make life in the kitchen easier than ever. Try some of our other countertop appliances, cookware, tools and gadgets.

www.cuisinart.com

www.cuisinart/esspressomaker.com

©2013 Cuisinart
150 Milford Road
East Windsor, NJ 08520
Printed in China

13CE136851

Any other trademarks or service marks referred to herein are the trademarks or service marks of their respective owners.

IB-11869