



### READ AND FOLLOW ALL SAFETY INSTRUCTIONS.

- Review the diagrams thoroughly before beginning.
- All electrical connections must be in accordance with local codes, ordinances, and the National Electric code. If you are unfamiliar with methods of installing electrical wiring, secure the services of a qualified licensed electrical.
- Before starting the installation, disconnect the power by turning off the circuit breaker or by removing the appropriate fuse at the fuse box. Turning the power off using the light switch is not sufficient to prevent electrical shock.
- Do not use outdoors.
- Do not let power supply cords touch hot surfaces.
- Do not mount near gas or electric heaters.
- Use caution when servicing batteries. Battery acid can cause burns to skin and eyes. If acid is spilled on skin or in eyes, flush acid with fresh water and contact a physician immediately.
- Equipment should be mounted in location and at heights where it will not readily be subject to tampering by unauthorized personnel.
- The use of accessory equipment not recommended by the manufacturer may cause an unsafe condition.
- Do not use this equipment for other than intended use.
- All servicing should be performed by qualified personnel only.
- Allow battery to charge for 24 hours before first use.

### SAVE THESE INSTRUCTIONS

### What's In The Box



One (1) EXL6

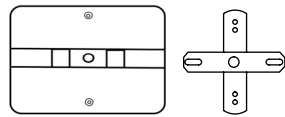

One (1) Mounting Kit

### Tools Needed

A Phillips screwdriver will be needed to install the EXL6. A drill is needed to remove the knockouts if back mounting.



### Installing the EXL6



*Make sure all power is turned off before beginning installation*

#### 1 Preparation

- Carefully unpack the exit light from its packaging.
- Inspect product for defects due to shipping.

#### For single or double face:

- Remove EXIT faceplate from the housing by pulling from the top (see figure 1)
- Remove the hole plugs from the top (or side) of the housing depending on installation desired.
- Remove the proper directional chevron(s) (figure 2) from the EXIT faceplate(s) carefully, as needed. (CAUTION: remove carefully to avoid surface damage).

#### For double face only:

- Remove the back plate from the housing by removing screws (4pcs) at the corner of the frame.
- Assemble the second EXIT faceplate to the frame using the screws (4pcs).

#### For Wall (back) mount only

- Remove the knock out hole on the center of back plate. Then remove the oblong knock outs on the back plate that correspond to junction box holes to be used. (See diagram 3)

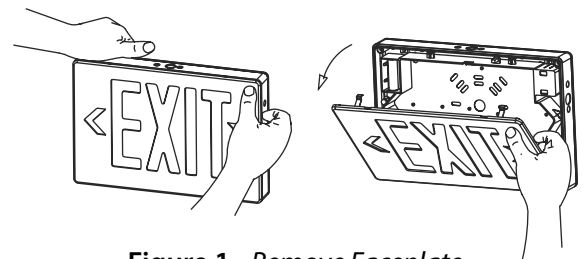

Figure 1 - Remove Faceplate



Figure 2  
Remove  
Chevrons

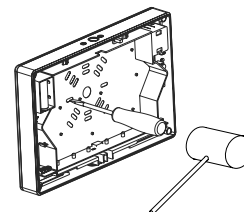

Figure 3  
Remove  
Knockouts

### 2 Mounting and Wiring

#### Ceiling or Side Mount (See figures 4 and 5)

- Secure canopy to the housing using hole numbers "2" and "3" on the canopy with provided canopy screws : (2) #10-24 screws.
- Feed AC supply leads through top (or side) hole on the housing and the crossbar, then make the proper supply lead connections per the wiring diagram. Cap off unused wires.
- Install crossbar to the junction box.
- Connect battery to circuit board connector.
- Push excess wire into junction box and align holes in canopy with those in crossbar. Using screws supplied, tighten canopy to crossbar so that canopy is securely fastened and tight against ceiling (or wall).
- Snap EXIT faceplate(s) onto the housing, bottom first and then top. (See Figure 7)

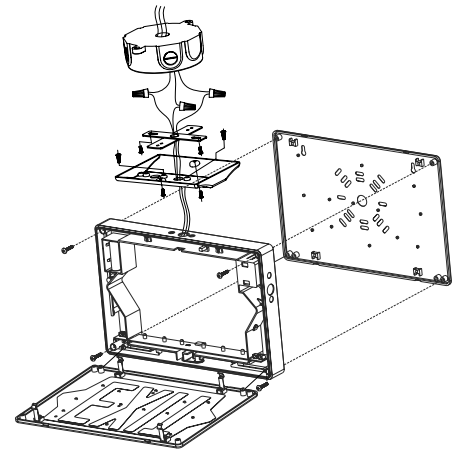

Figure 4 - Ceiling Mount

#### Back Mounting (See figure 6)

- Feed AC supply leads through center hole on the back plate, then make the proper supply lead connections per the wiring diagram. Cap off unused wires.
- Connect battery to circuit board connector.
- Feed excess wire into junction box and secure back plate to junction box.
- Snap EXIT faceplate onto the housing, bottom first and then top. (See figure 7)

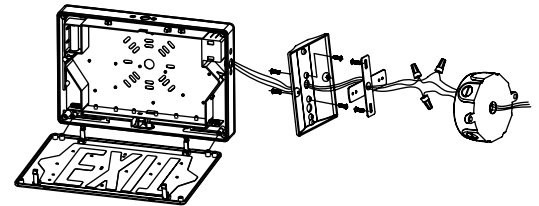

Figure 5 - Side Mount

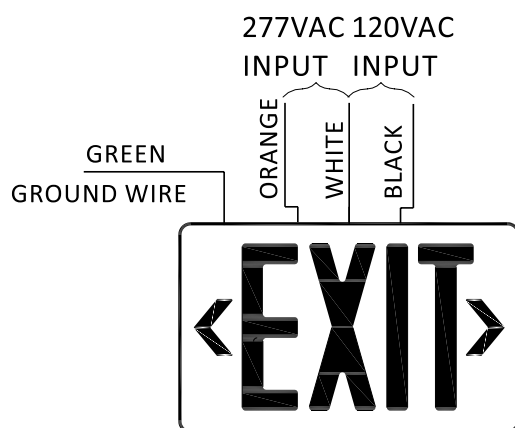

Figure 8 - Wiring Diagram

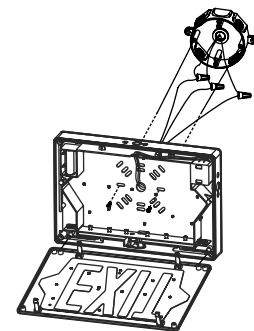

Figure 6 - Back Mount

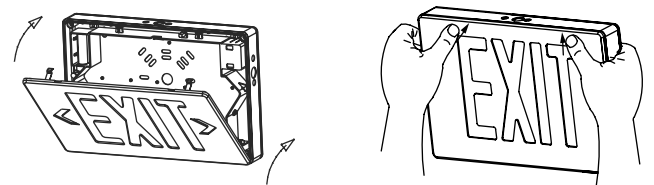

Figure 7 - Replace Faceplate

### 3 Operating status:

#### Non Self Diagnostic Unit

- The indicator light shows if the unit has normal AC power connected and active.
- The test button should be pressed and function of the sign tested per NFPA 101.

#### Self Diagnostic Unit

When AC power is supplied to fixture, the unit will automatically initiate a self-test and self-diagnostic test as follows:

- Verifies battery disconnection & charger board failure every 5 seconds.
- 1 minute self-test every month.
- 30 minutes self-test every 6 months after installation.
- 90 minutes self-test every 12 months after installation.
- 

Dual color LED lamp indicator shows the following status:

- Green color steady on: Ready
- Green color blinking Testing
- Red color blinking Service Alert - see diagnostic chart

	Light Status	Meaning
●	One blink ON/pause every 4 seconds	Battery is not connected
● ●	Two blinks ON/pause every 4 seconds	Battery voltage lower than acceptable value
● ● ●	Three blinks ON/pause every 4 seconds	Charger board fault
● ● ● ●	Four blinks ON/pause every 4 seconds	Transfer function failure
● ● ● ● ● ● ●	Seven blinks ON/pause every 4 seconds	LED strip fault

#### NOTICE

After solving the fault of the exit sign, please press and hold the test button for 2 seconds to reset. LED indicator will show green when fault is cleared.

### 4 For manual test, press test button as follows:

- Press test button once within 2 seconds 30 second test
- Press test button twice within 2 seconds 3 minutes test
- Press test button 3 times within 2 seconds 30 minutes test
- Press test button 4 times within 2 seconds 90 minutes test

#### NOTE

Battery Testing: Allow 24 hours of charging before testing.

- Push In TEST Button - LED display will switch to battery power and remain lit
- Release TEST Button - LED display will switch back to AC power

GENERAL PRODUCT WARRANTY. Each NICOR product will be free from defect in materials and workmanship for a period of one (1) year from the date of delivery to the end-user. Powder Coat paint finish on products, other than natural aluminum or brass, will not exhibit cracking, peeling, excessive fading, or corrosion during the warranty period. Exceptions apply as defined in each NICOR product's specification sheets, which are incorporated by reference herein. Warranty does not cover improper installation, operation, alterations, power surges, overheating due to external conditions, or acts of nature including but not limited to lightning strikes.

ALL NICOR WARRANTIES APPLY ONLY TO NICOR PRODUCTS THAT HAVE BEEN PURCHASED FROM AN AUTHORIZED NICOR DISTRIBUTOR; WHO PURCHASED THE PRODUCT DIRECTLY FROM NICOR; THE PRODUCT WAS NEW AND IN AN UNOPENED NICOR PACKAGE AT THE TIME OF INSTALLATION; AND WAS INSTALLED BY A LICENSED ELECTRICIAN OR UNDER THE SUPERVISION OF A LICENSED ELECTRICIAN.

This device complies with part 15 of the FCC Rules. Operation is subject to the following two conditions: (1) This device may not cause harmful interference, and (2) this device must accept any interference received, including interference that may cause undesired operation.

NOTE: This equipment has been tested and found to comply with the limits for a Class B digital device, pursuant to part 15 of the FCC Rules. These limits are designed to provide reasonable protection against harmful interference in a residential installation. This equipment generates, uses and can radiate radio frequency energy and, if not installed and used in accordance with the instructions, may cause harmful interference to radio communications. However, there is no guarantee that interference will not occur in a particular installation. If this equipment does cause harmful interference to radio or television reception, which can be determined by turning the equipment off and on, the user is encouraged to try to correct the interference by one or more of the following measures:

- Reorient or relocate the receiving antenna.
- Increase the separation between the equipment and receiver.
- Connect the equipment into an outlet on a circuit different from that to which the receiver is connected.
- Consult the dealer or an experienced radio/TV technician for help



**EXL6 Die Cast LED Exit Sign**

**INSTALLATION INSTRUCTIONS**

Models: EXL6 Standard or Self Diagnostic