



Surge Protection Device

(20kV/10kA)

120-277V LSP15277S, 95036608 (35-413462-21)

347-480V LSP15480S, 95036609 (35-413462-22)



BEFORE YOU BEGIN

Read these instructions and save for future use.

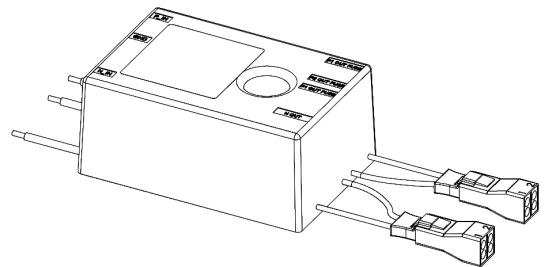

⚠ WARNING
RISK OF ELECTRIC SHOCK
 Disconnect power before servicing or installing product.

⚠ CAUTION
RISK OF INJURY
 Wear safety glasses and gloves during installation and servicing.

Circuit Diagram

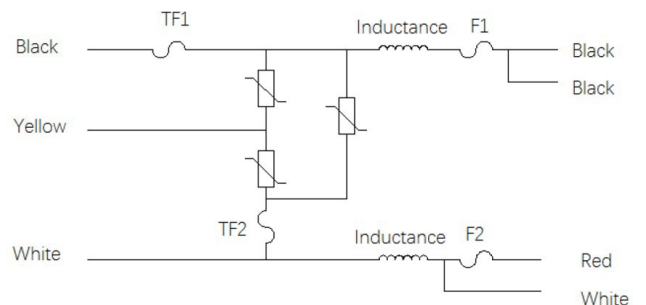

Line To Line Wiring (Typical for 208V, 240V, and 480V input)

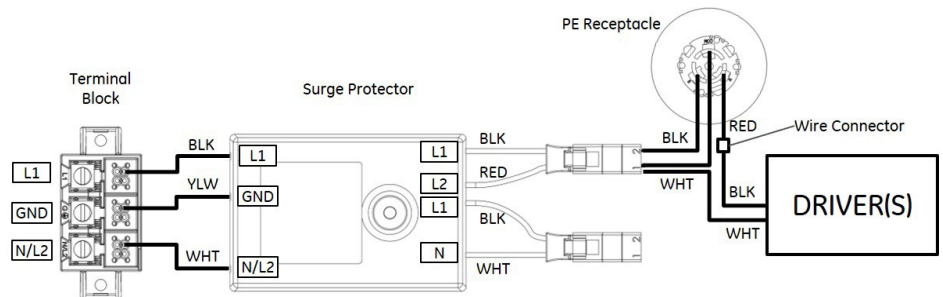

Line To Neutral Wiring (Typical for 120V, 277V, and 347V input)

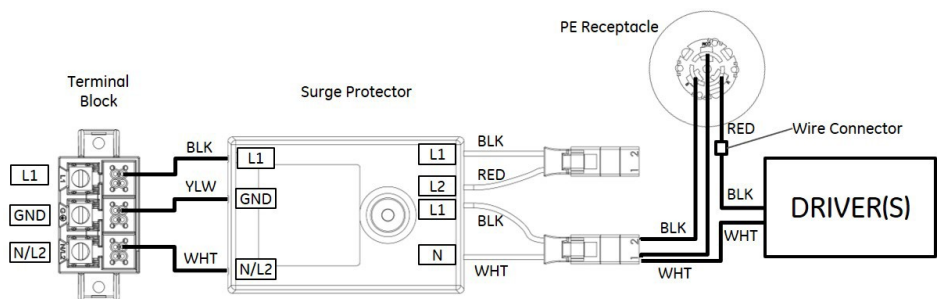

These instructions do not purport to cover all details or variations in equipment nor to provide for every possible contingency to be met in connection with installation, operation or maintenance. Should further information be desired or should particular problems arise which are not covered sufficiently for the purchaser's purposes, the matter should be referred to Current.

Appareil de protection contre les surtensions (20kV/10kA)



120-277V LSP15277S, 95036608 (35-413462-21)
347-480V LSP15480S, 95036609 (35-413462-22)



AVANT DE COMMENCER

Lisez ces instructions et conservez-les pour une utilisation future.

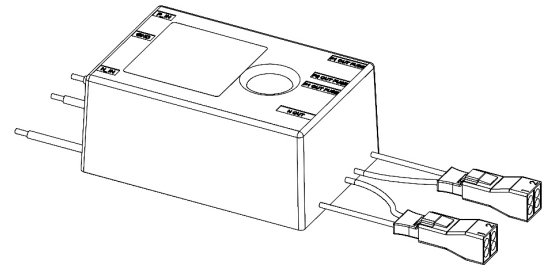

⚠ AVERTISSEMENT
RISQUE D'ÉLECTROCUTION
Coupez l'alimentation avant l'installation ou un entretien de ce produit.

⚠ ATTENTION
RISQUE DE BLESSURE
Portez des lunettes de sécurité et des gants lors de l'installation et des entretiens.

Schéma de circuit

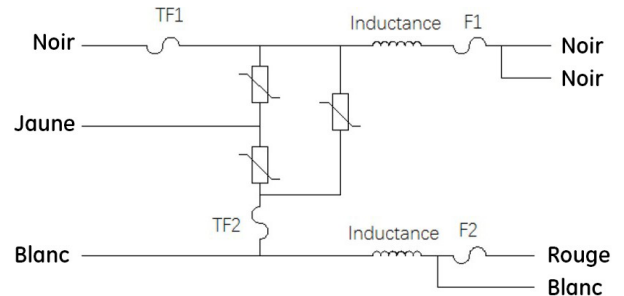

Câblage ligne vers ligne (Typique pour alimentation en 208 V, 240 V et 480 V)

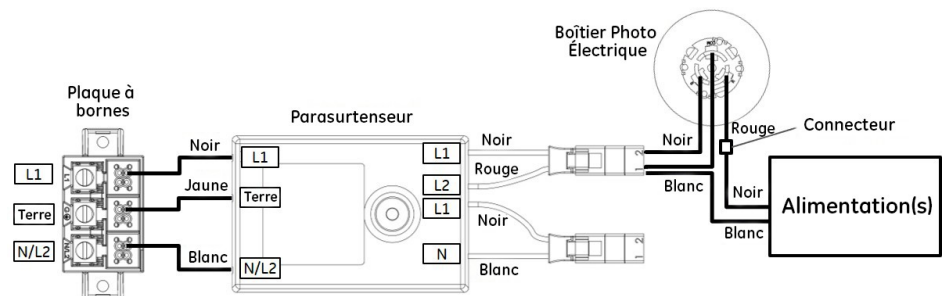

Câblage ligne vers neutre (Typique pour alimentation en 120 V, 277 V et 347V)

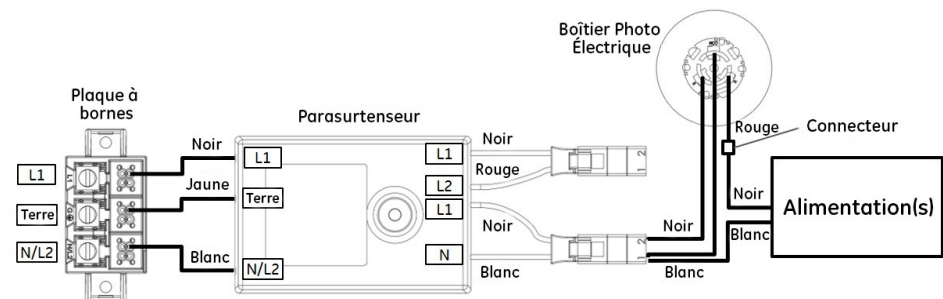

Ces instructions ne prétendent pas couvrir tous les détails ou variantes de l'équipement ni couvrir toutes les conditions possibles à satisfaire en rapport avec l'installation, l'opération ou l'entretien. Si des informations supplémentaires sont souhaitées sur des aspects qui ne sont pas suffisamment couverts pour satisfaire les besoins du client, ou si des problèmes particuliers se présentent, veuillez adresser ces questions à Current.



Protector de sobretensiones

(20kV/10kA)

120-277V LSP15277S, 95036608 (35-413462-21)

347-480V LSP15480S, 95036609 (35-413462-22)



ANTES DE COMENZAR

Lea estas instrucciones y guárdelas para uso futuro.

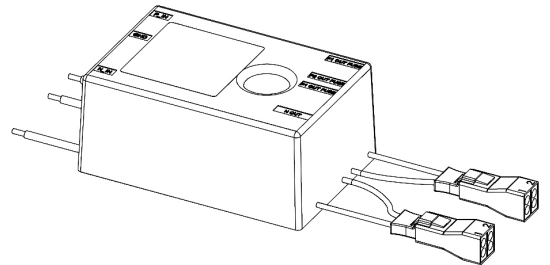

⚠ ADVERTENCIA

RIESGO DE CHOQUE ELÉCTRICO

Desconecte la alimentación antes del mantenimiento o la instalación del producto.

⚠ PRECAUCIÓN

RIESGO DE LESIONES

Utilice gafas y guantes de seguridad durante la instalación y mantenimiento.

Diagrama del circuito

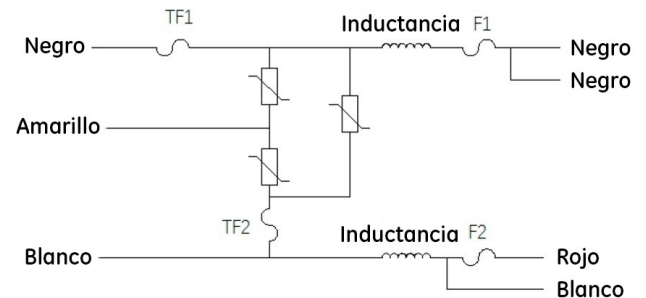

Cableado de línea a línea

(Típico para una entrada de 208V, 240V, y 480V)

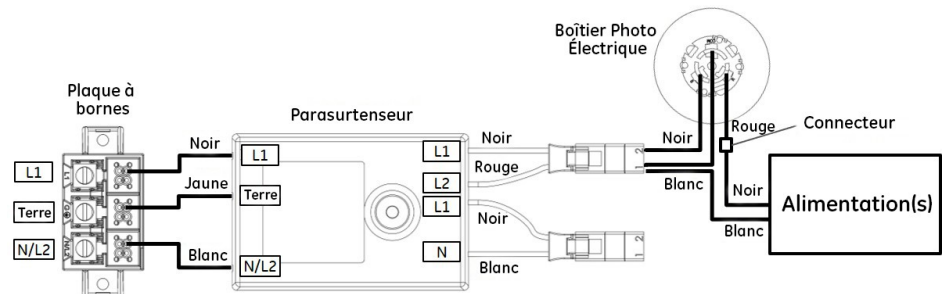

Cableado de línea a neutro

(Típico para una entrada de 120V, 277V, y 347V)

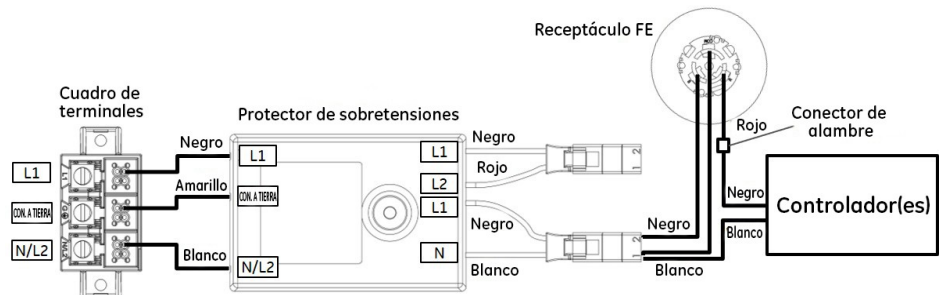

Estas instrucciones no pretenden cubrir todos los detalles o variaciones en el equipo ni para prevenir cualquier contingencia que debe cumplir en relación con la instalación, la operación o el mantenimiento. De ser deseada más información o se surgieran problemas particulares que no están cubiertos suficientemente para los propósitos del comprador, favor de remitirse a Current.