

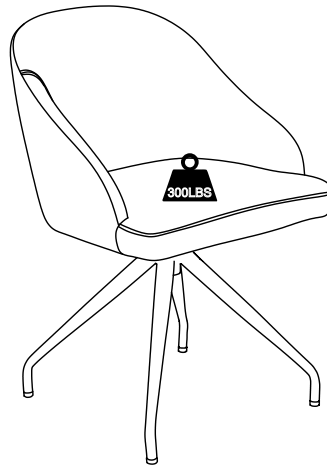

# Office Chair

196861189227  
196861189234  
196861041501  
196861041518  
196861041525



## ASSEMBLY INSTRUCTIONS

### Before You Begin:

Please identify all component parts and hardware pieces required before you begin. Carefully remove all of the components from the packaging and set aside for assembly. Assemble on a soft surface to prevent scratching during assembly.

### Caution:

Tighten all components securely before use. Failure to do so may result in personal injury. DO NOT use any sharp objects to open plastic wrapped components as damage to product or components may result.



### Warning:

**CHOKING HAZARD** - Small Parts. Adult Assembly Required.

**DO NOT ALLOW CHILDREN TO CLIMB ON FURNITURE**

Serious or fatal injuries can occur from furniture tipping over.

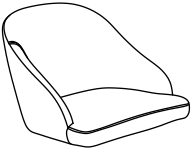
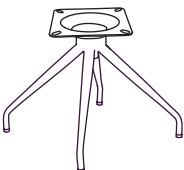
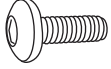
# PARTS

| PART1   | QTY:1 | PART2   | QTY:1 | PART3   | QTY:4 | PART4   | QTY:4 | PART5   | QTY:1 |
|---|-------|---|-------|---|-------|---|-------|---|-------|
|  |       |  |       |  |       |  |       |  | M6    |
| Backrest  |       | Metal Base  |       | M6*20 Bolt  |       | φ6 Washer   |       | Allen Wrench  |       |

# STEP 1

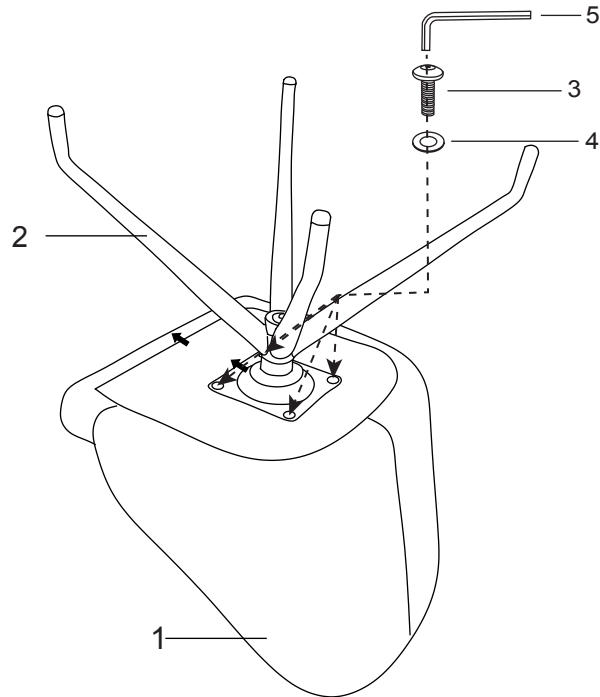

# STEP 2

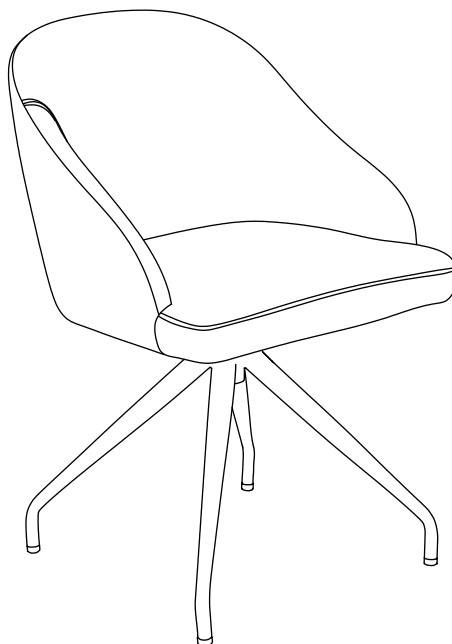

## QUALITY AND SAFETY GUIDELINES

- Please follow the static and dynamic weight capacity limits provided on this item. If you are unsure of the weight capacities for this product, email us at [customerexperience@theubiquegroup.com](mailto:customerexperience@theubiquegroup.com) or call 866-552-2810.
- Please use this item on a stable, level surface only. All chair legs should contact the flooring surface when in use. Do not use this item if any instability is detected.
- For maintenance instructions and replacement parts, please email us at [customerexperience@theubiquegroup.com](mailto:customerexperience@theubiquegroup.com) or call 866-552-2810.
- This item is intended for sitting only, do not climb or stand on this item.
- This chair is not intended for reclined positions. To prevent accidental tipping, do not push backward or forward while seated.
- To prevent pinching or crushing injuries, ensure all areas are clear when rotating the chair.
- This item is intended for indoor use only.
- Store indoors away from moisture. For additional storage instructions, please email us at [customerexperience@theubiquegroup.com](mailto:customerexperience@theubiquegroup.com) or call 866-552-2810.
- Please visit [www.theubiquegroup.com](http://www.theubiquegroup.com) for our product warranty details or email us at [customerexperience@theubiquegroup.com](mailto:customerexperience@theubiquegroup.com) or call 866-552-2810.
- Please review and retain all assembly instructions, safety and quality guidelines and product warnings for future reference.