



PRISM PLUS

*Matte Black Hardware Finish, Black Base Shown

Specification Features

- KIT INCLUDES: PRISM PLUS NEO-ANGLE ENCLOSURE AND SHOWER BASE
- PRISM PLUS SHINES WITH OBSTRUCTION-FREE DESIGN BRACKETS
- REVERSIBLE FOR A RIGHT-HAND OR LEFT-HAND DOOR OPENING
- PATENTED L-BARS FOR AN UNOBSTRUCTED LOOK & EXTRA SUPPORT
- UP TO 1/4 IN. PER SIDE FOR WIDTH OR OUT-OF-PLUMB
- 3/8 IN. (10 MM) THICK CERTIFIED CLEAR TEMPERED GLASS
- CLEARMAX WATER AND STAIN RESISTANT GLASS COATING
- SELF-CLOSING HINGES DELIVER ADDITIONAL COMFORT





Technical Information

- Model: Prism Plus
- Product Type: Enclosure and Base Kit
- Kit Dimensions: 42 in. D x 42 in. W x 74 3/4 in. H
- Access Width Max: 23 1/8"
- Access Width Min: 23 1/8"
- Glass Thickness: 3/8" [10 mm]
- Glass Type: Clear
- Glass Coating: ClearMax
- Drain Location: Corner

Codes/Standards Applicable

- ANSI Z97.1 (Tempered Glass)
- 16 CFR Part 1201

Hardware Finish Options:

-  01 - Chrome
-  04 - Brushed Nickel
-  06 - Oil Rubbed Bronze
-  09 - Matte Black

Model SKU#s:

White Base	Biscuit Base	Black Base
DL-6063-01	DL-6063-22-01	DL-6063-88-01
DL-6063-04	DL-6063-22-04	DL-6063-88-09
DL-6063-06	DL-6063-22-06	
DL-6063-09		

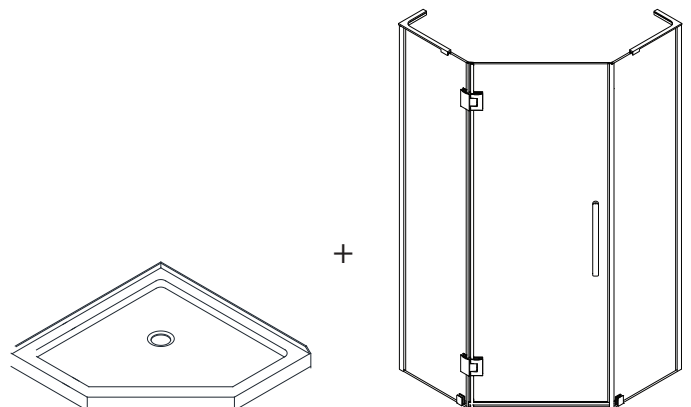

Available Product Configurations:

Shower Enclosure Model SKU#s:

SHEN-2634340-XX	34 in. x 72 in.
SHEN-2636360-XX	36 in. x 72 in.
SHEN-2638380-XX	38 in. x 72 in.
SHEN-2640400-XX	40 in. x 72 in.

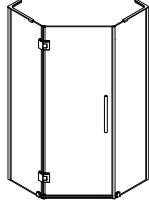

Shower Enclosure and Base Kit SKU#s:

DL-6060-XX	36 in. x 36 in. x 74 3/4 in.
DL-6061-XX	38 in. x 38 in. x 74 3/4 in.
DL-6062-XX	40 in. x 40 in. x 74 3/4 in.
DL-6063-XX	42 in. x 42 in. x 74 3/4 in.

+



+

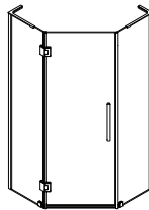

Important Notes:

If this unit is going to be installed in a new construction, please, install all of the required plumbing and drainage before installing the shower. Use a competent and licensed plumber for all plumbing installation period.

Adjustment: up to 1/4 in. per side for width or out-of-plumb (uneven walls).

Bases must be installed direct-to-stud; Shower enclosures or doors require finished (tiled) walls.

Professional installation recommended. Please consult the technical drawing for precise drain location.

Important Disclaimers:

- Prior to installation, please ensure that the installation surface is finished, level and solid and will be able to support the total weight of the unit. Also, make sure that the walls are plumb. Irregular installation, surface level or out of square conditions can result in serious problems for your installation.
- Please read Installation Manual thoroughly prior to installing this product.
- Please note that you should consult your local building codes with questions on installation compliance standards. Building and plumbing codes may vary by location, and DreamLine® is not responsible for code compliance standards for your project and will not accept any returns.

For commercial customers, we strongly recommend the use of Dreamline's Onsite Contractor Support option.