

2304079 Outdoor Kitchen Loading Diagram

8 Kitchen Pallet A, 6 Kitchen Pallet B, total 30 sets.
 3 Grill Pallet A, 1 Grill Pallet B, total 30 sets.
 5 Fridge Pallet, total 30 sets.
 Total 23 pallets/40HQ, gross weight: 16550Kg

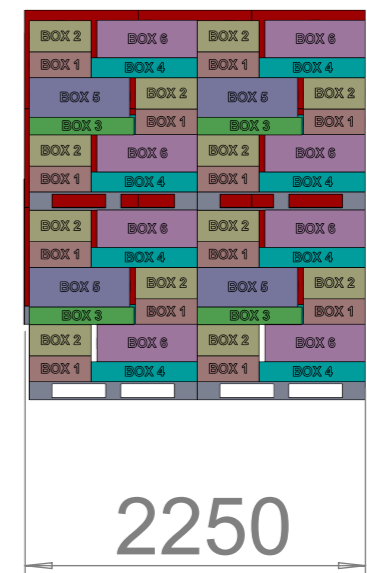
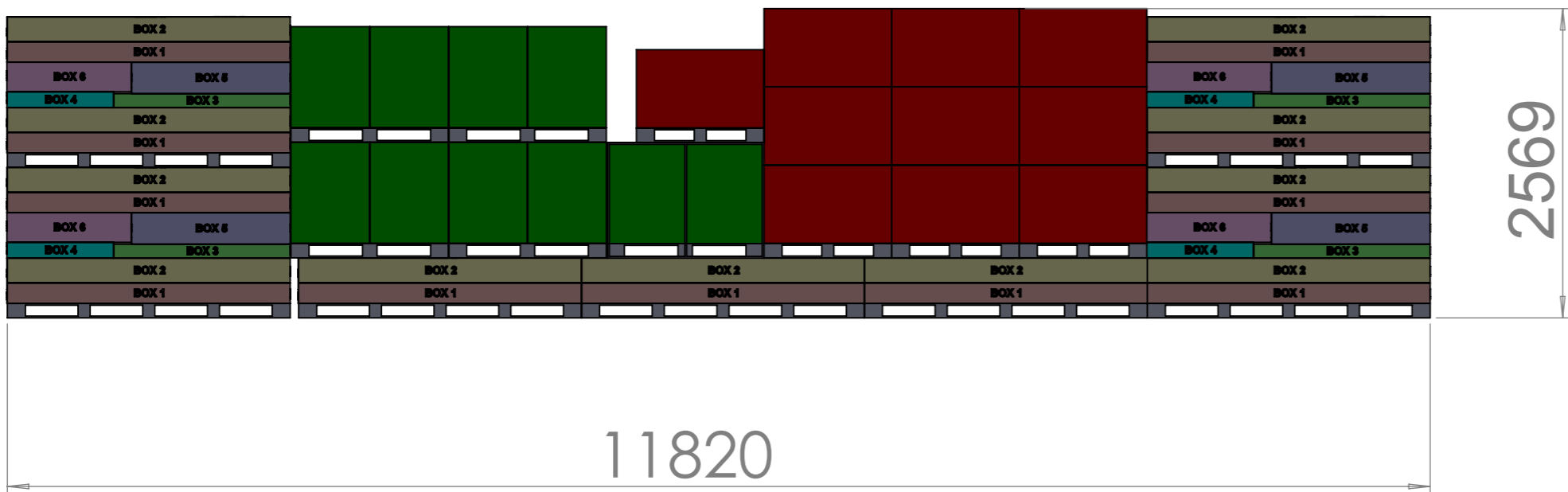
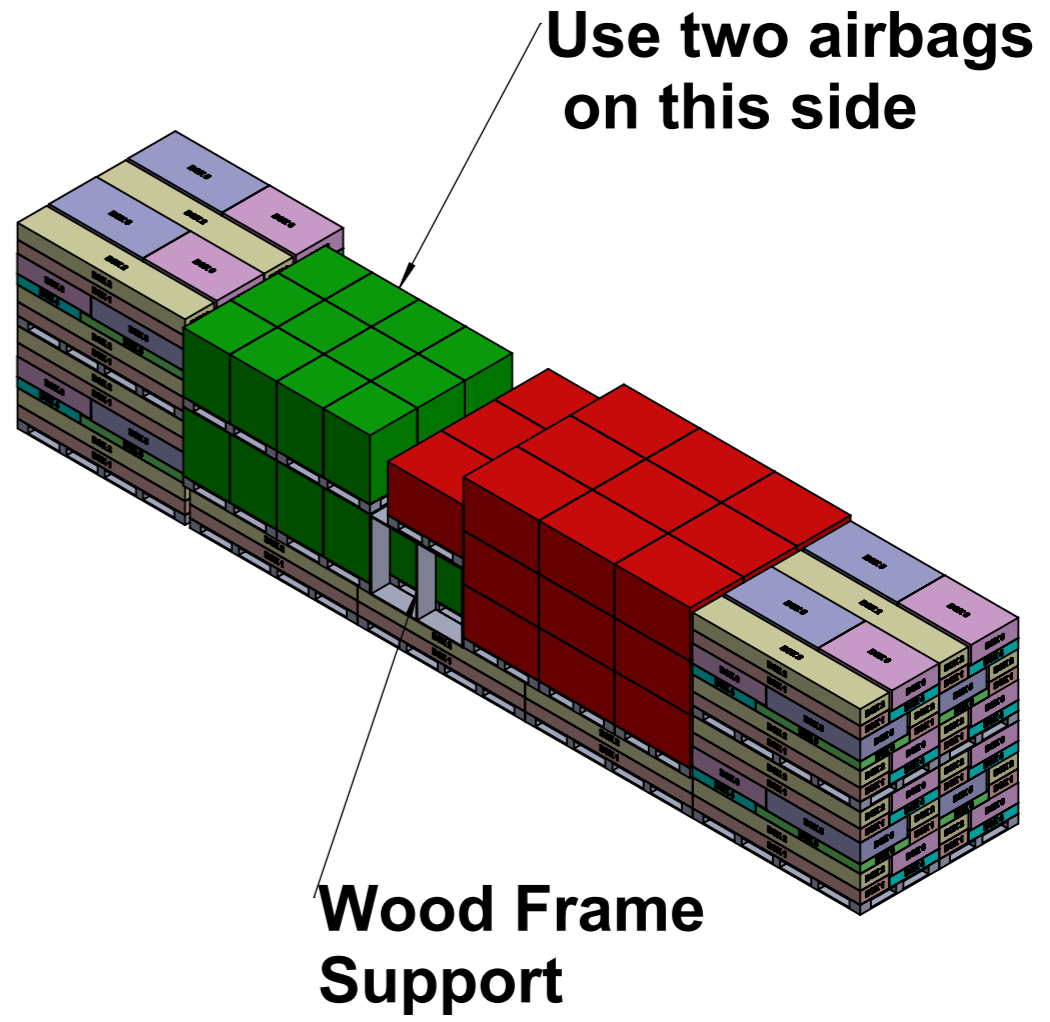
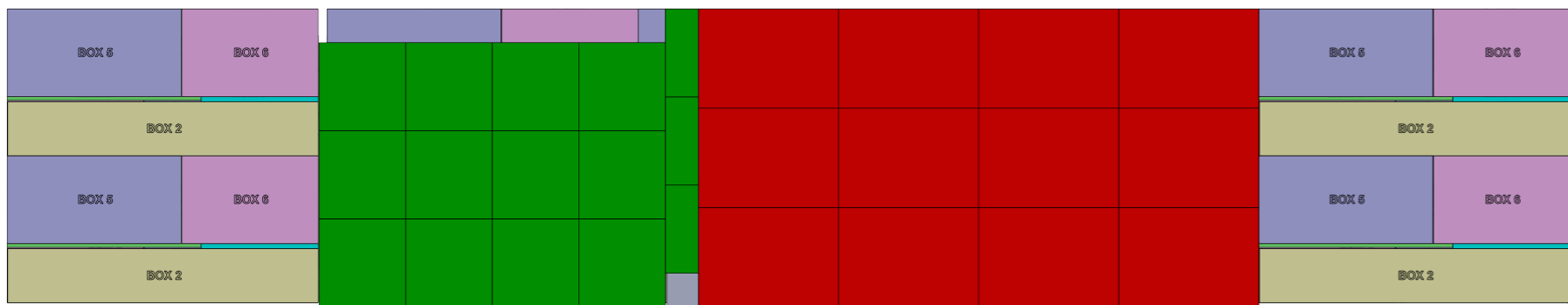

Kitchen Pallet A Detailed Information

3 sets/pallet, total 8 Pallets

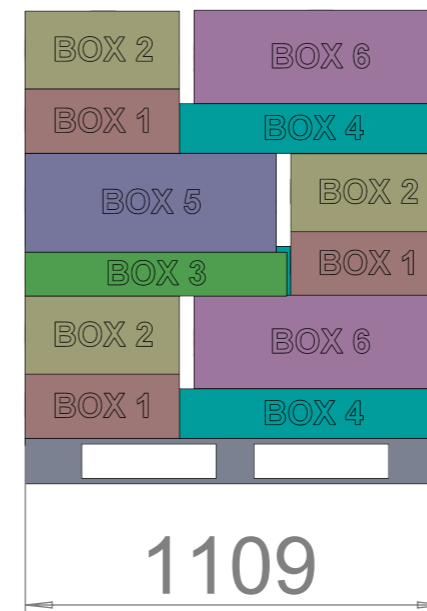
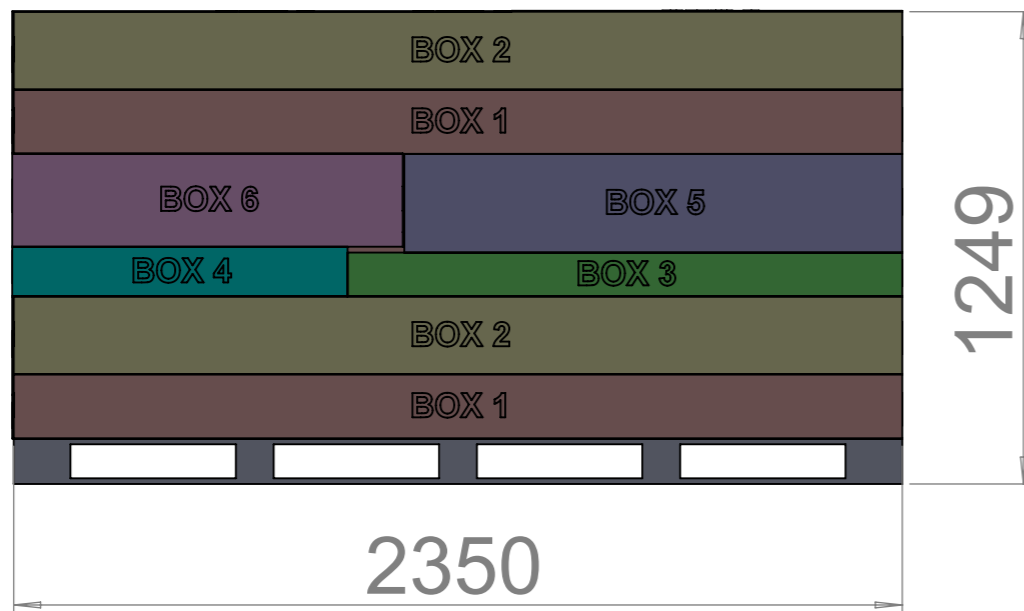
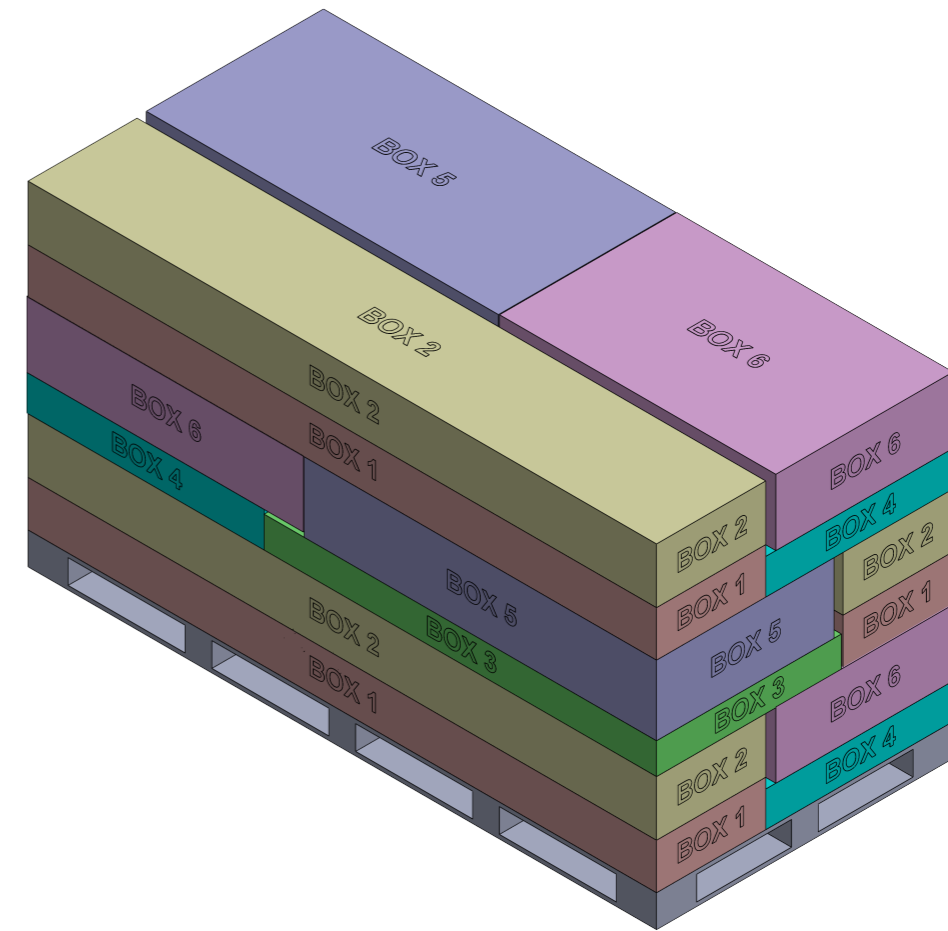
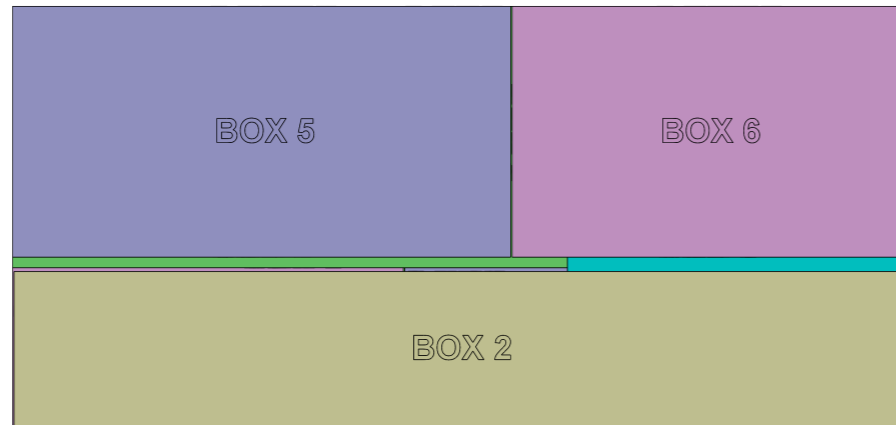

Kitchen Pallet B Detailed Information

1 set/pallet, total 6 Pallets

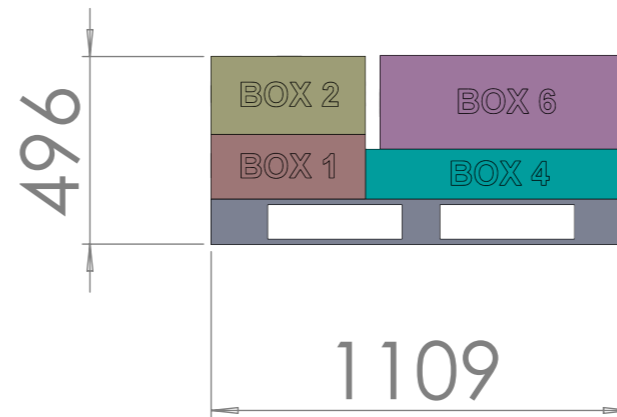
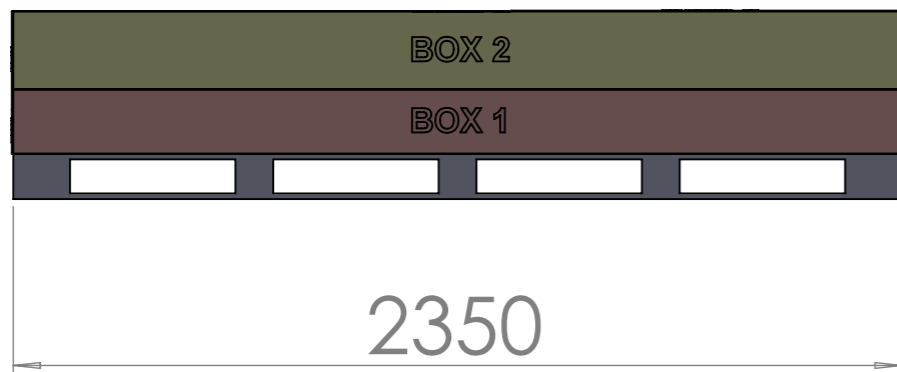
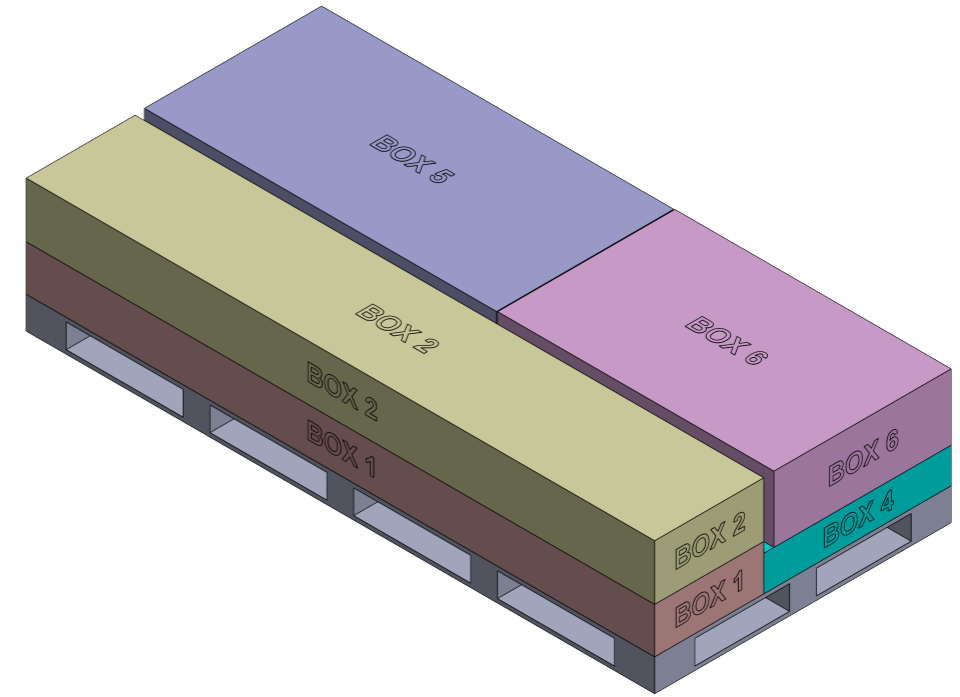
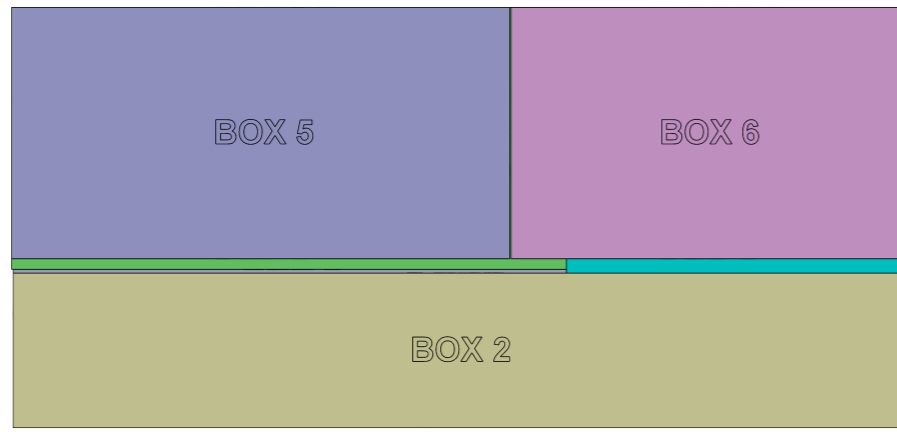

Kitchen BOX Detailed Information

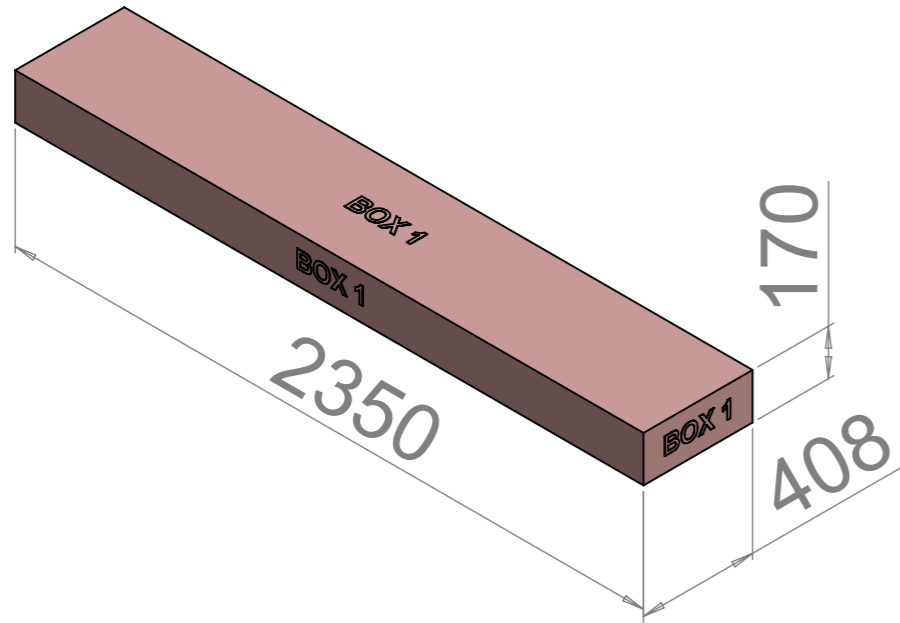

BOX 1 60Kg

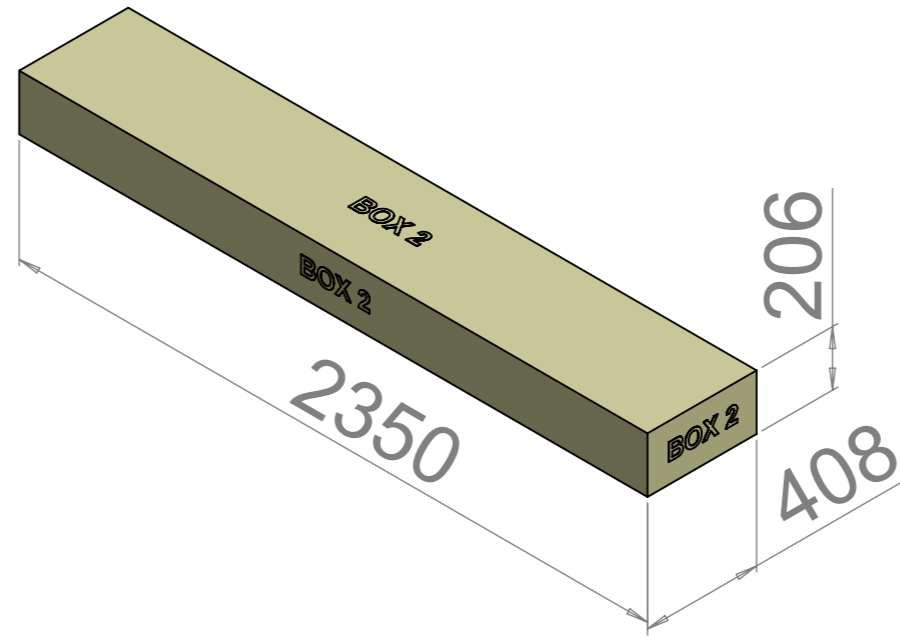

BOX 2 61Kg

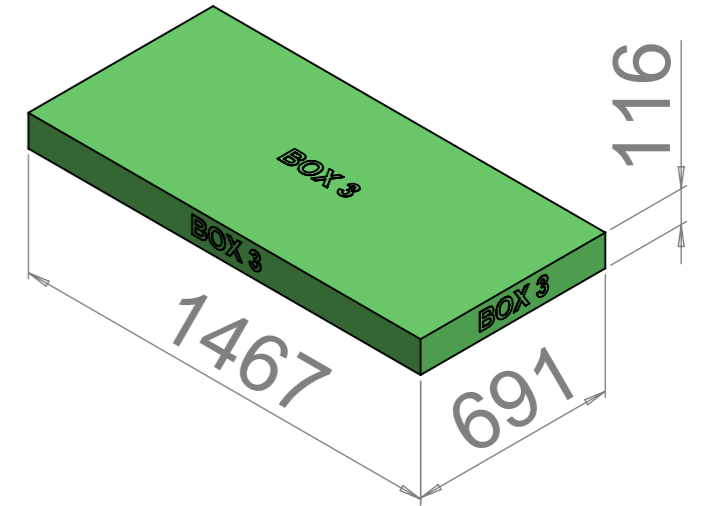

BOX 3 44.5Kg

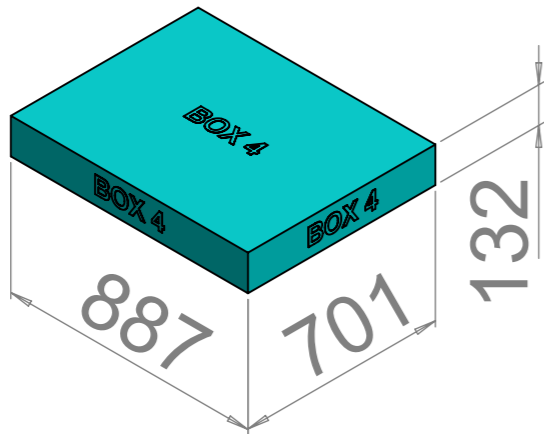

BOX 4 40Kg

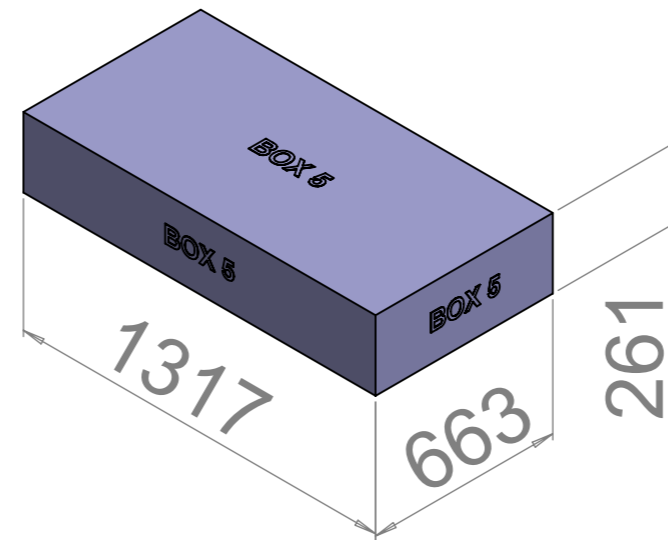

BOX 5 76Kg

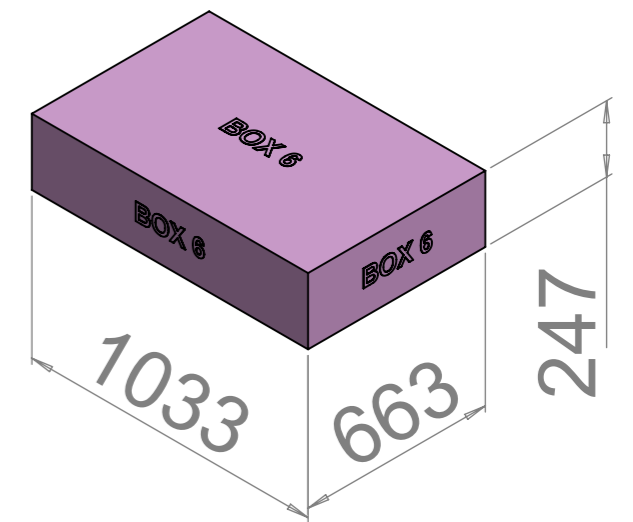

BOX 6 56Kg

Wood Frame Support Detailed Information

Material: 15mm thick plywood

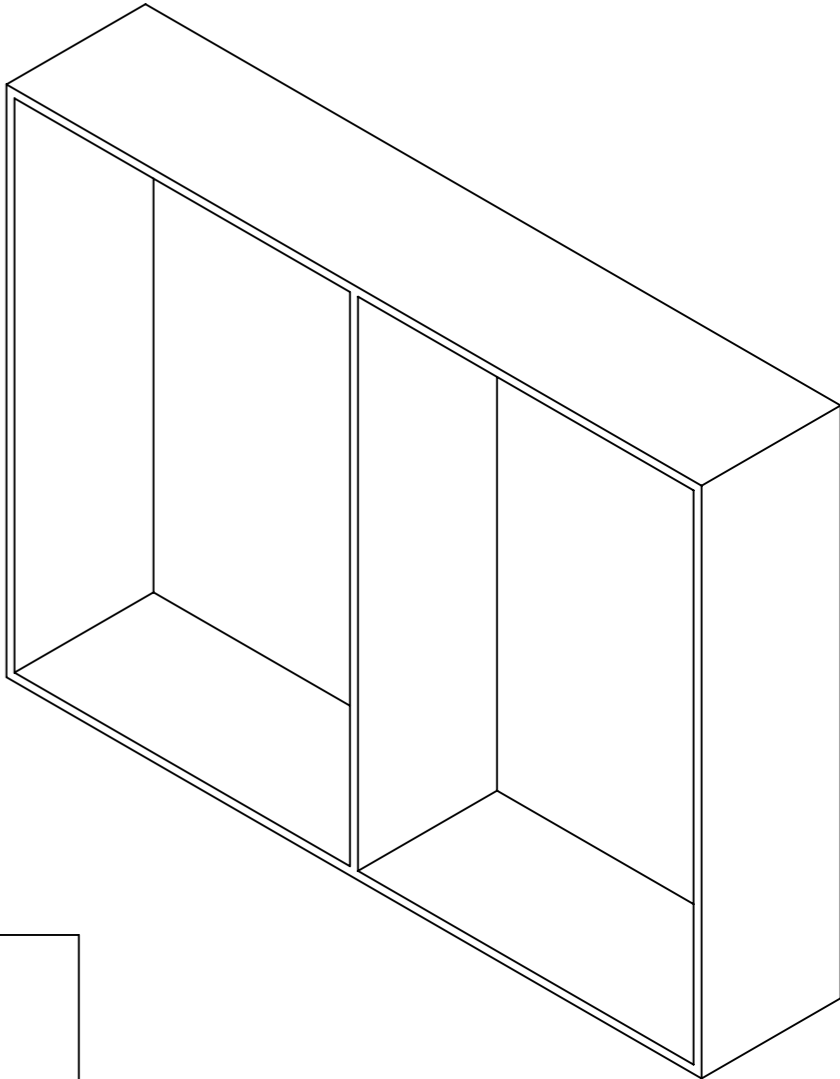
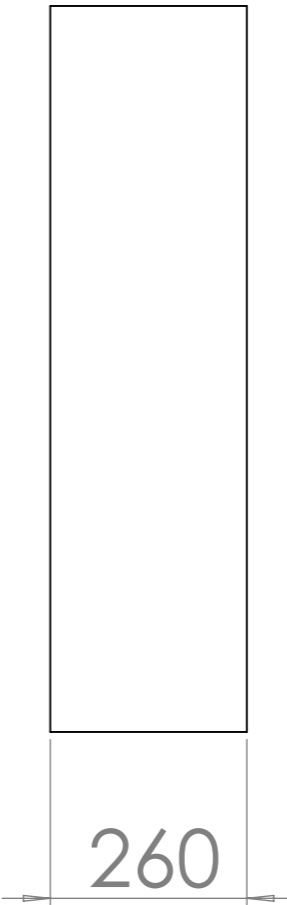
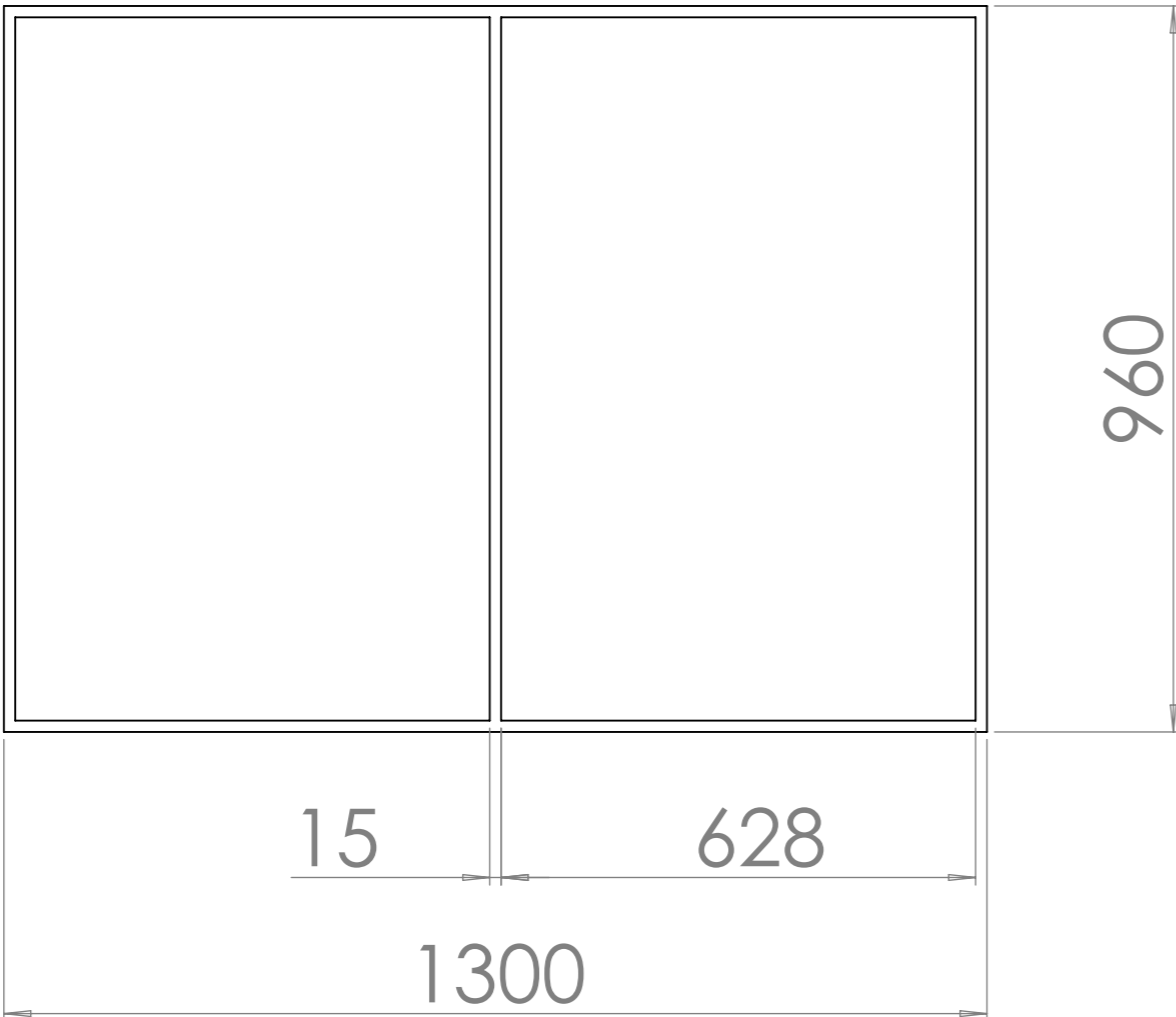

8 7 6 5 4 3 2 1

F

E

D

C

B

A

F

E

D

C

B

A

Grill Pallet A Detailed Information

9 sets/pallet, total 3 Pallets

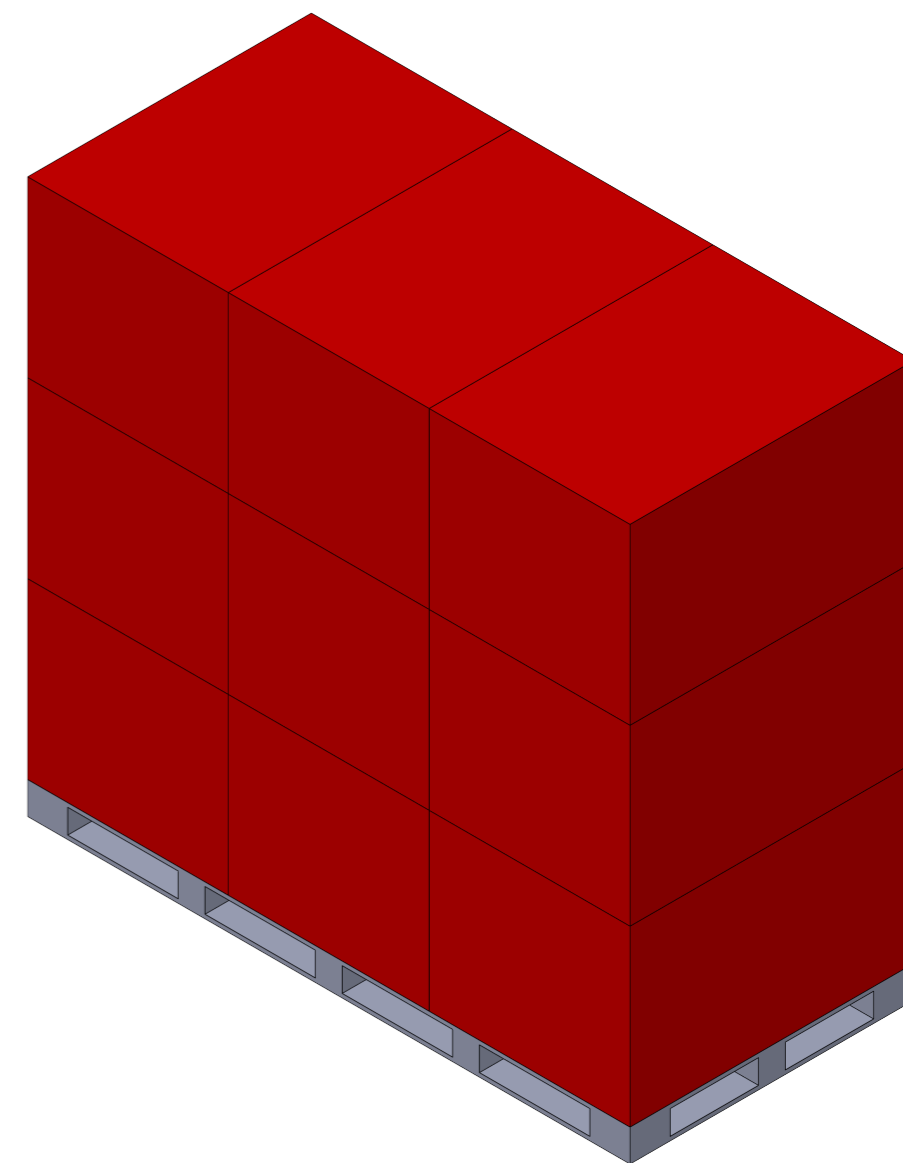
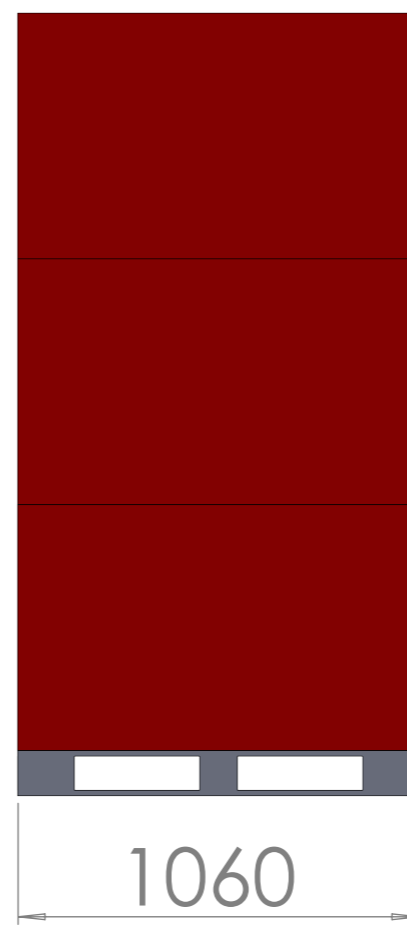
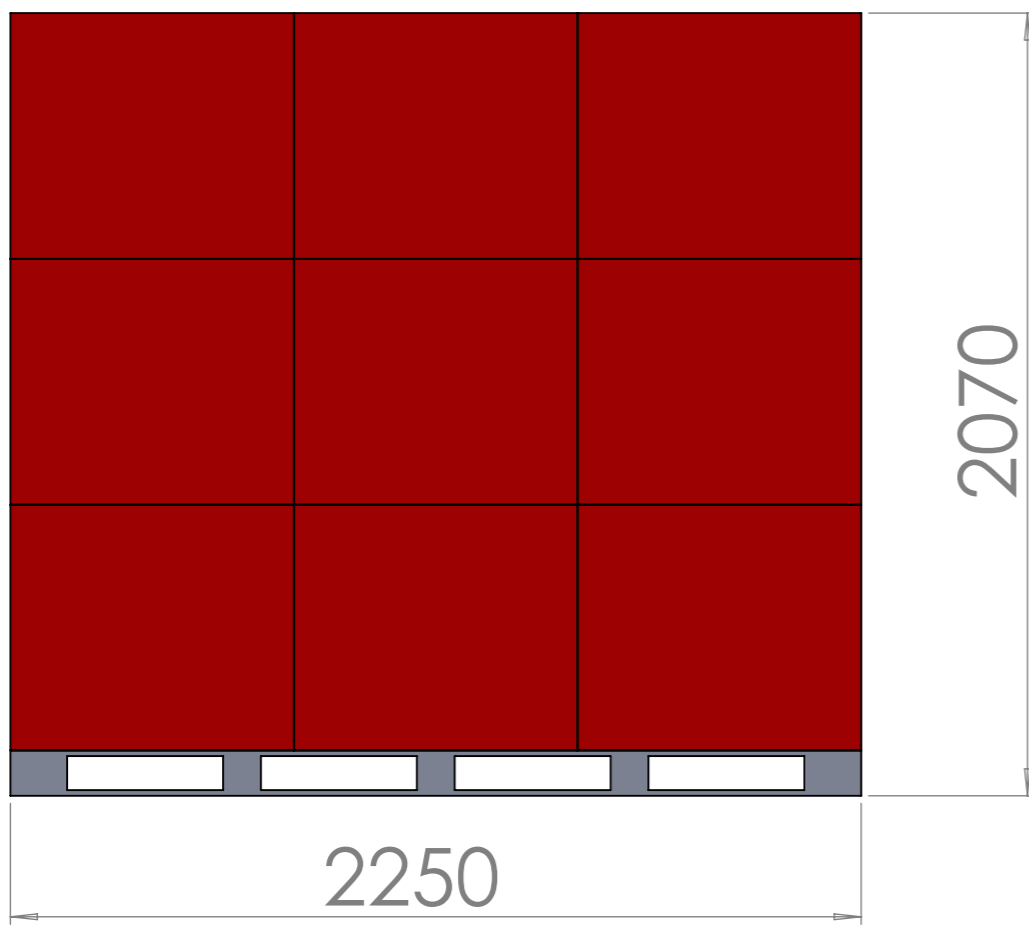
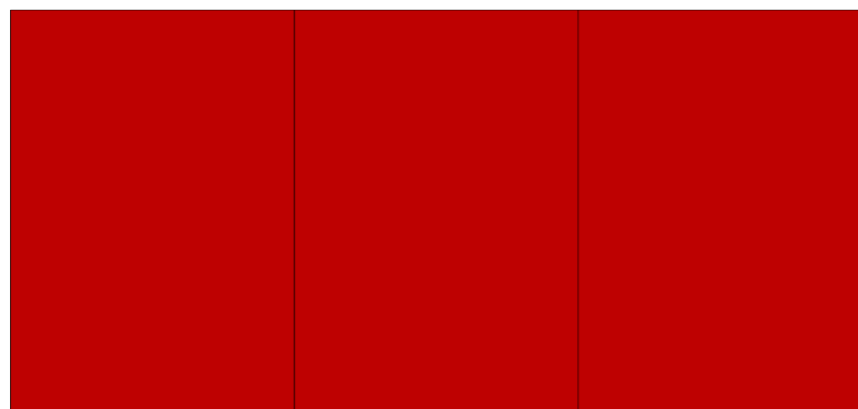

Grill Pallet B Detailed Information

3 sets/pallet, total 1 Pallet

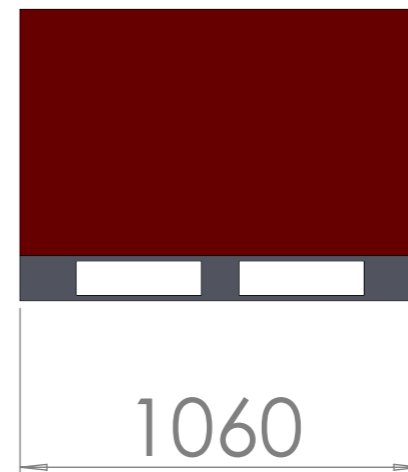
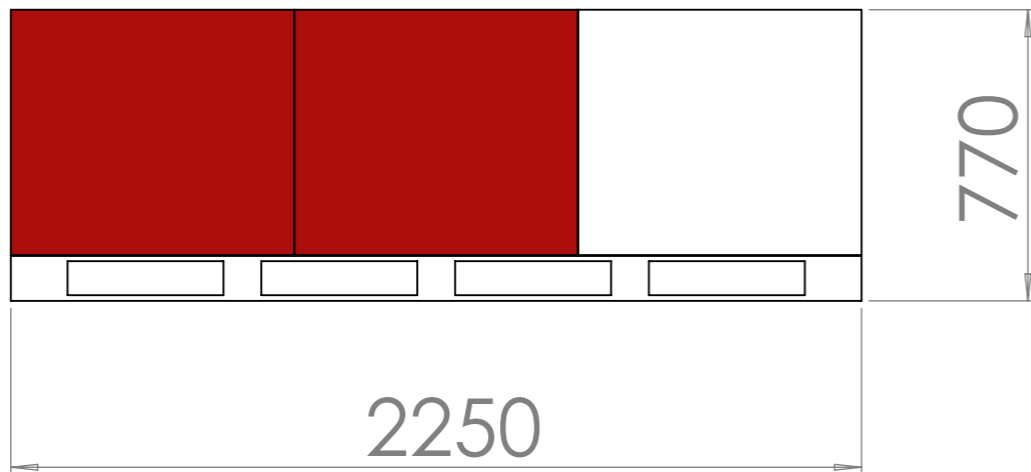
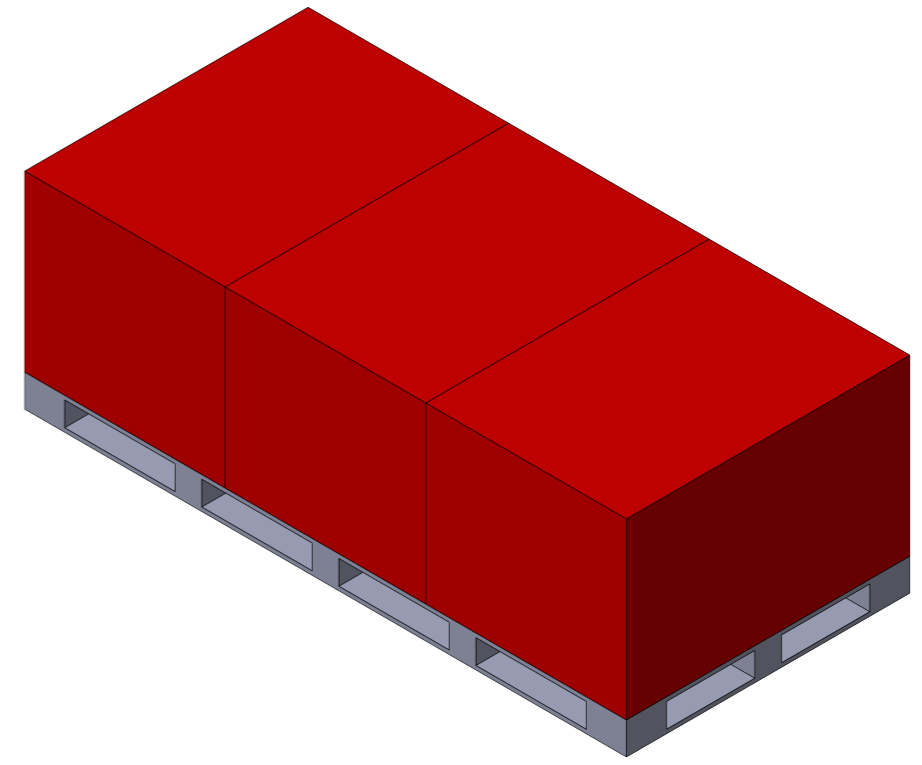
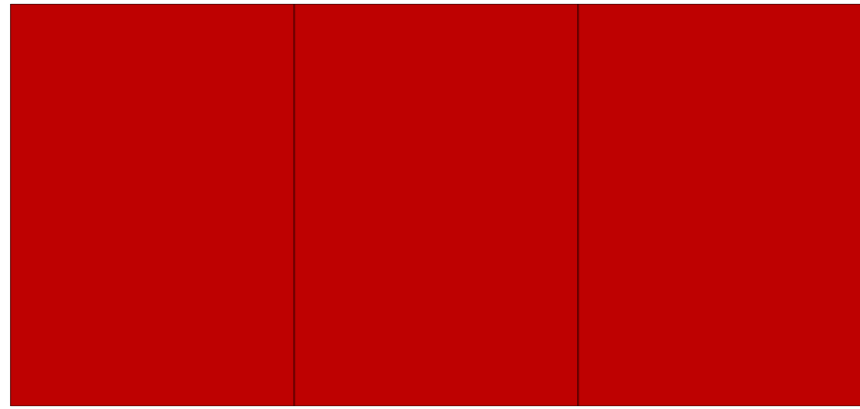

Grill Box Detailed Information

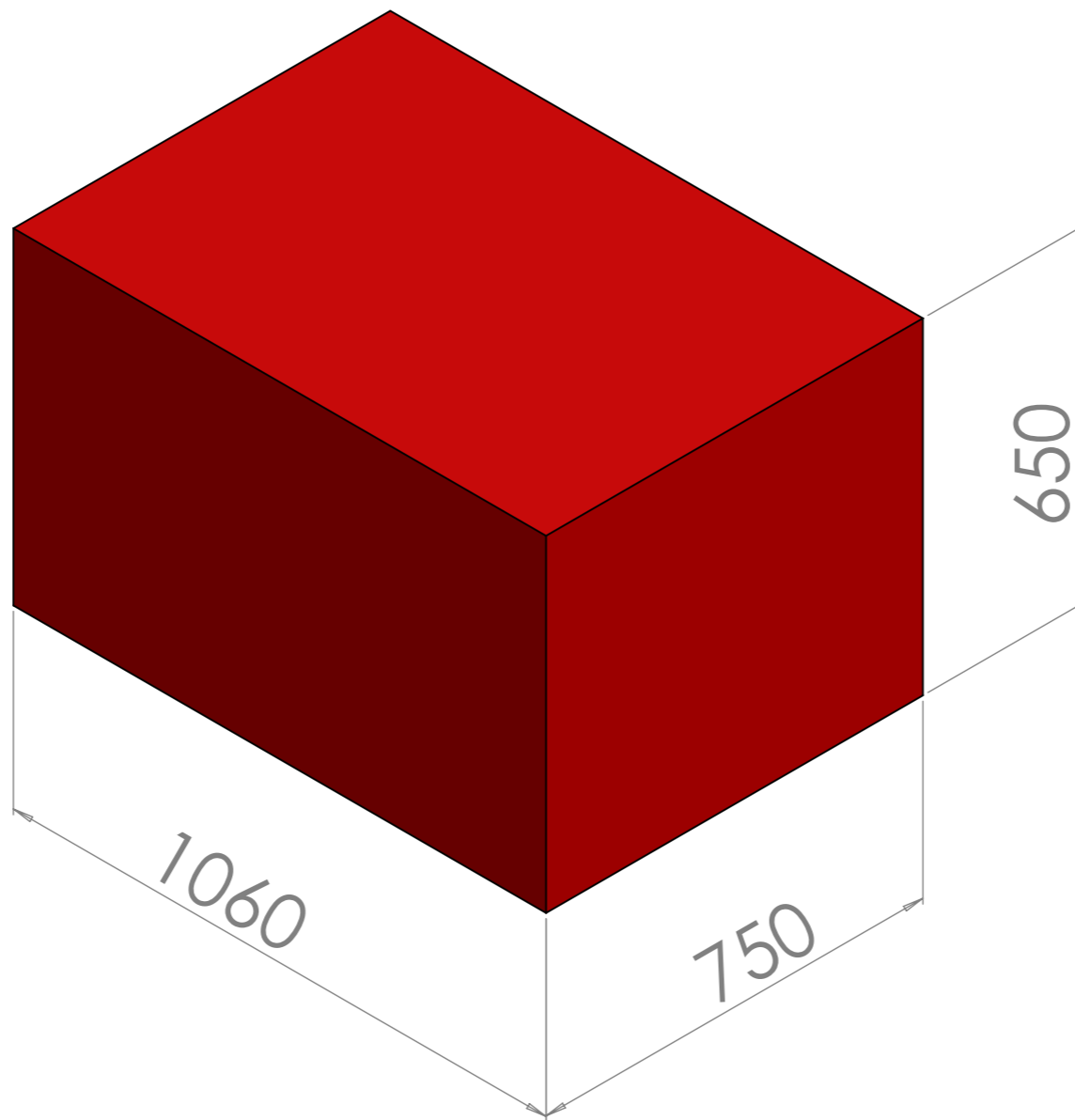

Gross Weight: 80 Kg

Fridge Pallet Detailed Information

6 sets/pallet, total 5 Pallets

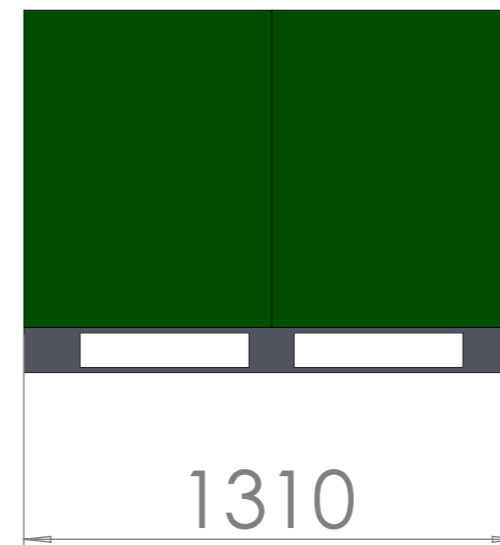
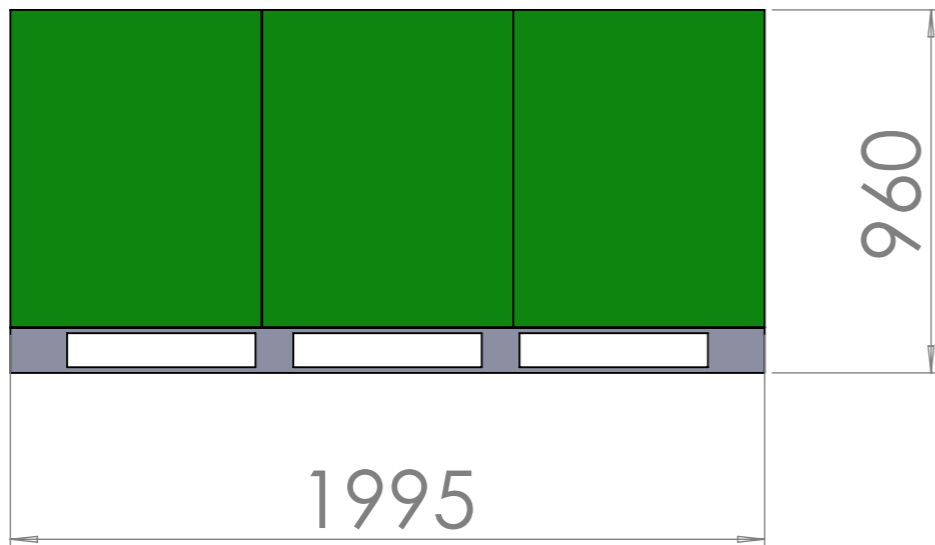
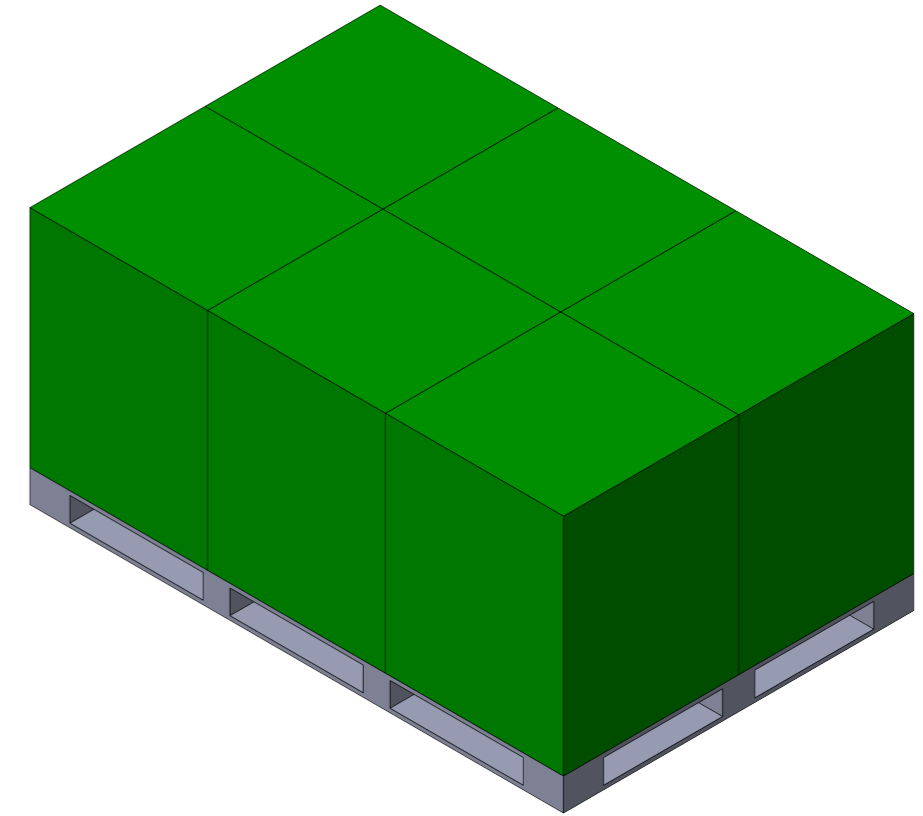
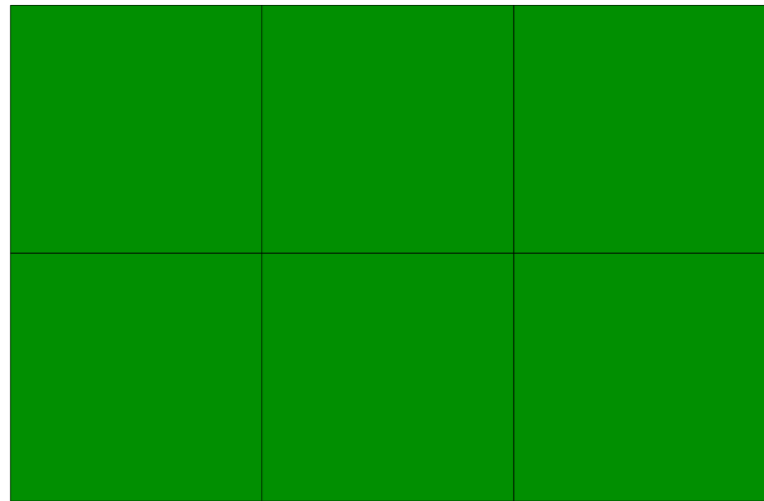

Fridge BOX Detailed Information

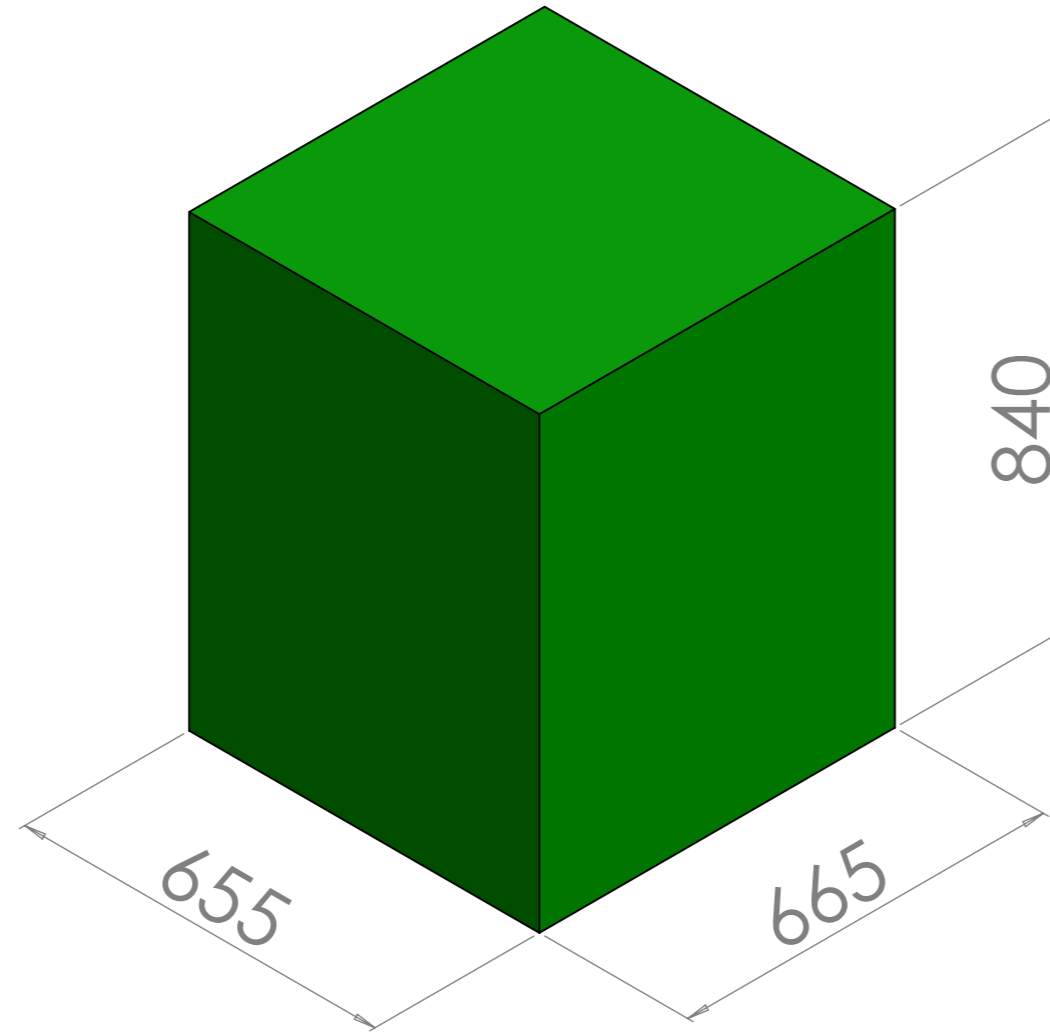

Gross Weight: 78Kg