



Matte Black Hardware Finish Shown

PRIME

Specification Features

- KIT INCLUDES SHOWER ENCLOSURE, BASE AND BACKWALLS
- SPACE-SAVING CURVED CORNER DESIGN
- DUAL CENTER-SLIDING DOORS. LUXURIOUS AESTHETIC FIT
- FULL LENGTH MAGNETIC STRIP FOR WATERTIGHT CLOSURE
- WALL PROFILES ALLOW UP TO 1 IN. ADJUSTMENT PER SIDE
- 1/4 IN. (6 MM) THICK CERTIFIED CLEAR TEMPERED GLASS
- STYLISH ACRYLIC WALL KIT. 2 GLASS SHELVES
- MODERN LOW PROFILE SLIMLINE SHOWER BASE

Technical Information

- Model: Prime
- Product Type: Enclosure, Base & Backwalls
- Dimensions: 33 in. Dx 33 in. W x 76 3/4 in. H
- Access Width Max: 18 11/16 in.
- Access Width Min: 18 11/16 in.
- Glass Thickness: 1/4" [6 mm]
- Glass Type: Clear

Codes/Standards Applicable

- ANSI Z97.1 (Tempered Glass)
- 16 CFR Part 1201

Hardware Finish Options:

- 01 - Chrome
- 04 - Brushed Nickel
- 06 - Oil Rubbed Bronze
- 09 - Matte Black

Model SKU#s:

- DL-6152-01CL DL-6152-04CL
- DL-6152-06CL DL-6152-09CL

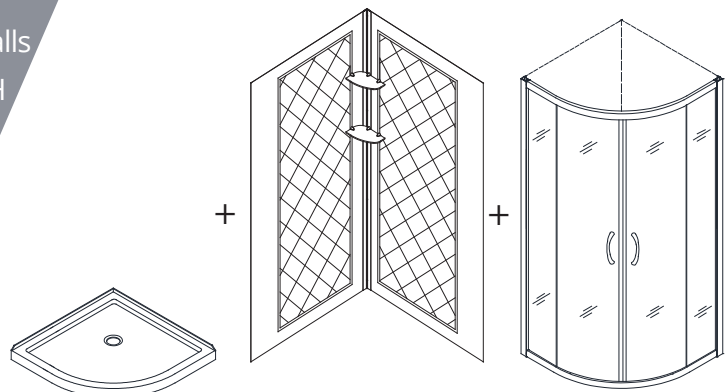

Available Product Configurations:

Shower Enclosure Model SKU#s:

SHEN-7031310-XX 31 3/8 in. x 31 3/8 in.
SHEN-7034340-XX 34 3/8 in. x 34 3/8 in.
SHEN-7036360-XX 36 3/8 in. x 36 3/8 in.

Frosted Glass Enclosures:

SHEN-7031310-XX-FR 31 3/8 in. x 31 3/8 in.
SHEN-7034340-XX-FR 34 3/8 in. x 34 3/8 in.
SHEN-7036360-XX-FR 36 3/8 in. x 36 3/8 in.

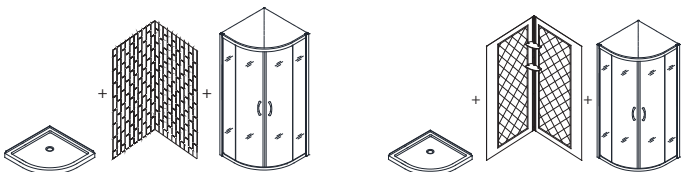

Complete Shower Kit SKUs:

E2703333XXQ00XX
E2703636XXQ00XX
E2703838XXQ00XX

Frosted Glass Kits:

E2703333XFQ00XX
E2703636XFQ00XX
E2703838XFQ00XX

Complete Shower Kits:

DL-6152-XXCL
DL-6153-XXCL
DL-6154-XXCL

Frosted Glass Kits:

DL-6152-XXFR
DL-6153-XXFR
DL-6154-XXFR

Important Notes:

If this unit is going to be installed in a new construction, please, install all of the required plumbing and drainage before installing the shower. Use a competent and licensed plumber for all plumbing installation period.

Anodized aluminum wall profiles allow up to 1 in. adjustment per side.

Bases must be installed direct-to-stud; Shower enclosures or doors require finished (tiled) walls.

Professional installation recommended. Please consult the technical drawing for precise drain location.

Important Disclaimers:

- Prior to installation, please ensure that the installation surface is finished, level and solid and will be able to support the total weight of the unit. Also, make sure that the walls are plumb. Irregular installation, surface level or out of square conditions can result in serious problems for your installation.
- Please read Installation Manual thoroughly prior to installing this product.
- Please note that you should consult your local building codes with questions on installation compliance standards. Building and plumbing codes may vary by location, and DreamLine® is not responsible for code compliance standards for your project and will not accept any returns.

For commercial customers, we strongly recommend the use of Dreamline's Onsite Contractor Support option.