



UNIDOOR-X

Specification Features

- HINGED PANEL, SHOWER DOOR AND INLINE BUTTRESS PANEL
- REVERSIBLE FOR A RIGHT OR LEFT DOOR OPENING
- SOLID BRASS GLASS-TO-GLASS SELF-CLOSING HINGES
- 3/8 IN. (10 MM) THICK CERTIFIED CLEAR TEMPERED GLASS
- CLEARMAX WATER AND STAIN RESISTANT GLASS COATING
- FRAMELESS GLASS DESIGN TO GIVE AN OPEN AND AIRY FEEL

Technical Information

- Model: Unidoor-X
- Product Type: Hinged Shower Door
- Dimensions: 56 - 56 1/2 in. W x 72 in. H
- Access Width: 25 in.
- Hinged Panel Width: 6 in.
- Inline Buttress panel: 24 in. W x 34 in. H
- Glass Thickness: 3/8 in. (10 mm)
- Glass Pattern: Clear
- Glass Coating: ClearMax

Codes/Standards Applicable

- ANSI Z97.1 (Tempered Glass)
- 16 CFR Part 1201

Hardware Finish Options:

- 01 - Chrome
- 04 - Brushed Nickel
- 06 - Oil Rubbed Bronze
- 09 - Matte Black

Model SKU#s:

- D1262434-01 D1262434-04
- D1262434-06 D1262434-09

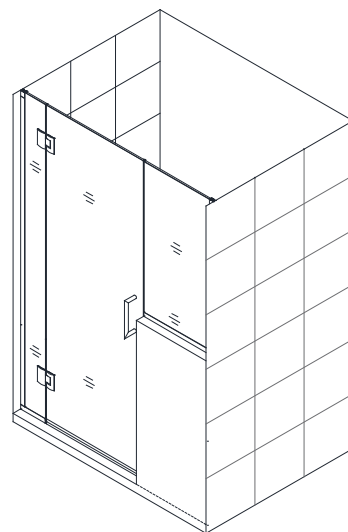

Unique Product Design Details:

Important Notes:



Custom Adjustment



Shower Door Handle



DreamLine exclusive ClearMax water and stain resistant glass coating

If this unit is going to be installed in a new construction, please, install all of the required plumbing and drainage before installing the shower. Use a competent and licensed plumber for all plumbing installation period.

Hinged and Inline panels are attached to the wall by 1 in. anodized aluminum U-channel. 1/2 in. width or out-of-plumb adjustment available within U-channel on Inline panel side. 1/4 in. out-of-plumb adjustment available within U-channel on Hinged panel side.

Professional installation recommended.

IMPORTANT! All measurements should be taken only AFTER walls are finished (tile, back walls, etc.).

Important Disclaimers:

- Prior to installation, please ensure that the installation surface is finished, level and solid and will be able to support the total weight of the unit. Also, make sure that the walls are plumb. Irregular installation, surface level or out of square conditions can result in serious problems for your installation.
- Please read Installation Manual thoroughly prior to installing this product.
- Please note that you should consult your local building codes with questions on installation compliance standards. Building and plumbing codes may vary by location, and DreamLine® is not responsible for code compliance standards for your project and will not accept any returns.

For commercial customers, we strongly recommend the use of Dreamline's Onsite Contractor Support option.

Dreamline's commercial warranty does not apply to damage or losses resulting from (i) other than normal and proper use and normal service conditions; (ii) improper installation, (iii) installation in or upon an unsuitable surface or areas; (iv) abuse, (v) accident, (vi) alteration, (vii) misuse, (viii) neglect, (ix) unauthorized repair or the failure to utilize suitably qualified and trained persons to perform service and/or repair of the Product, (x) improper maintenance, (xi) failure to follow installation, operating, cleaning or maintenance instructions, and (xii) use of "non-authorized" parts.