



Matte Black Hardware Finish Shown

UNIDOOR PLUS

Specification Features

- SHOWER DOOR, BUTTRESS PANEL, RETURN BUTTRESS PANEL
- FRAMELESS GLASS DESIGN TO GIVE AN OPEN AND AIRY FEEL
- REVERSIBLE FOR A RIGHT OR LEFT DOOR OPENING
- PREMIUM 3/8 IN. (10MM) THICK CERTIFIED TEMPERED GLASS
- SOLID BRASS WALL-TO-GLASS SELF-CLOSING HINGES
- 1/2 IN. WIDTH OR OUT-OF-PLUMB ADJUSTMENT
- CLEARMAX WATER & STAIN RESISTANT GLASS COATING

Technical Information

- Model: Unidoor Plus
- Door Style: Hinged Shower Enclosure
- Dimensions: 54 in. W x 30 3/8 in. D x 72 in. H
- Product Width: 54 in.
- Product Depth: 30 3/8 in.
- Access Width: 23 in.
- Product Height: 72 in.
- Inline Panel: 30 in. W x 36 in. H
- Return Panel: 30 3/8 in. W x 36 in. H
- Glass Thickness: 3/8 in. (10mm)
- Glass Coating: ClearMax

Codes/Standards Applicable

- ANSI Z97.1 (Tempered Glass)
- 16 CFR Part 1201

Hardware Finish Options:

- 01 - Chrome
- 04 - Brushed Nickel
- 06 - Oil Rubbed Bronze
- 09 - Matte Black

Model SKU#s:

- SHEN-2424303630-01 SHEN-2424303630-04
- SHEN-2424303630-06 SHEN-2424303630-09

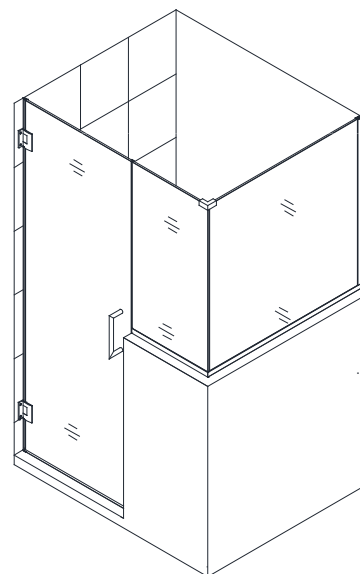

Product Details



ClearMax Glass Coating



Unique feature

Important Notes

If this unit is going to be installed in a new construction, install all of the required plumbing and drainage before installing the shower. Use a competent and licensed (if required by local code) plumber for all plumbing installation.

Make sure that prior to beginning the installation, the surfaces are leveled and solid and will be able to support the total weight of the unit. Also make sure the walls are at right angles. Irregular installation surface level, radius corners or improper angle of side walls will result in serious problems for your installation.

Please read Installation Manual thoroughly prior to installing this product.

Inline and Return Buttress Panels are attached to the wall by a 1 in. anodized aluminum U-channel. 1/2 in. width or out-of-plumb adjustment available on Inline Buttress panel side.

Important Disclaimers

Please note that you should consult your local building codes with questions on installation compliance standards. Building and plumbing codes may vary by location, and DreamLine® is not responsible for code compliance standards for your project and will not accept any returns.

For commercial customers, we strongly recommend the use of Dreamline's Onsite Contractor Support option.

Dreamline's commercial warranty does not apply to damage or losses resulting from (i) other than normal and proper use and normal service conditions; (ii) improper installation, (iii) installation in or upon an unsuitable surface or areas; (iv) abuse, (v) accident, (vi) alteration, (vii) misuse, (viii) neglect, (ix) unauthorized repair or the failure to utilize suitably qualified and trained persons to perform service and/or repair of the Product, (x) improper maintenance, (xi) failure to follow installation, operating, cleaning or maintenance instructions, and (xii) use of "non-authorized" parts.