



UNIDOOR

Specification Features

- CONFIGURATION: SWING DOOR WITH FIXED PANEL
- FRAMELESS GLASS DESIGN
- UP TO 1 IN. OF ADJUSTMENT FOR WIDTH OR OUT-OF-PLUMB
- REVERSIBLE FOR A RIGHT- OR LEFT-HAND DOOR OPENING
- CLEARMAX WATER AND STAIN RESISTANT GLASS COATING
- 3/8 IN. (10 MM) CERTIFIED TEMPERED GLASS
- SOLID BRASS WALL-TO-GLASS SELF-CLOSING HINGES
- PANEL REQUIRES A SUPPORT ARM FOR STABILITY

Technical Information

- Model: Unidoor
- Door Type: Hinged Shower Door
- Dimensions: 56 - 57 in. W x 72 in. H
- Product Width Max: 57"
- Product Width Min: 56"
- Access Width Max: 25"
- Access Width Min: 25"
- Glass Thickness: 3/8" [10 mm]
- Glass Type: Clear
- Glass Coating: ClearMax

Codes/Standards Applicable

- ANSI Z97.1 (Tempered Glass)
- 16 CFR Part 1201

Shower Model Option

- 01 - Chrome
- 04 - Brushed Nickel
- 06 - Oil Rubbed Bronze
- 09 - Satin Black

Model SKU#:

- SHDR-20567210-01
- SHDR-20567210-04
- SHDR-20567210-06
- SHDR-20567210-09

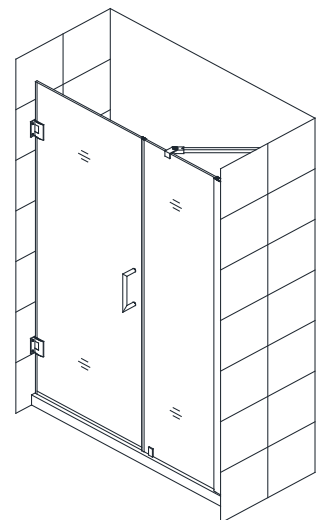

Left-swing installation shown

Available Product Configurations:

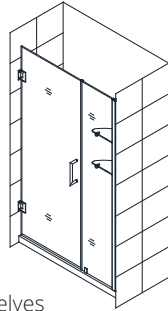
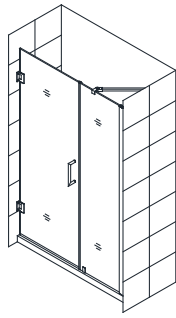

*with
two glass shelves

Model #s:

SHDR-20537210C-01 SHDR-20577210-01
SHDR-20537210C-04 SHDR-20577210-04
SHDR-20537210C-06 SHDR-20577210-06
SHDR-20537210C-09 SHDR-20577210-09
SHDR-20547210C-01 SHDR-20587210-01
SHDR-20547210C-04 SHDR-20587210-04
SHDR-20547210C-06 SHDR-20587210-06
SHDR-20547210C-09 SHDR-20587210-09
SHDR-20557210-01 SHDR-20597210-01
SHDR-20557210-04 SHDR-20597210-04
SHDR-20557210-06 SHDR-20597210-06
SHDR-20557210-09 SHDR-20597210-09
SHDR-20567210-01 SHDR-20607210-01
SHDR-20567210-04 SHDR-20607210-04
SHDR-20567210-06 SHDR-20607210-06
SHDR-20567210-09 SHDR-20607210-09

Model #s:

SHDR-20357210CS-01 SHDR-20397210S-01
SHDR-20357210CS-04 SHDR-20397210S-04
SHDR-20357210CS-06 SHDR-20397210S-06
SHDR-20357210CS-09 SHDR-20397210S-09
SHDR-20367210CS-01 SHDR-20407210S-01
SHDR-20367210CS-04 SHDR-20407210S-04
SHDR-20367210CS-06 SHDR-20407210S-06
SHDR-20367210CS-09 SHDR-20407210S-09
SHDR-20377210S-01 SHDR-20417210S-01
SHDR-20377210S-04 SHDR-20417210S-04
SHDR-20377210S-06 SHDR-20417210S-06
SHDR-20377210S-09 SHDR-20417210S-09
SHDR-20387210S-01 SHDR-20427210S-01
SHDR-20387210S-04 SHDR-20427210S-04
SHDR-20387210S-06 SHDR-20427210S-06
SHDR-20387210S-09 SHDR-20427210S-09

Important Notes:

All measurements should be taken only AFTER walls are finished (tile, Wall Kits, etc.)

Install this product according to the installation manual. Professional installation is recommended.

Up to 1 in. of adjustment for width or out-of-plumb (uneven walls).

For installation into a stud or other wood reinforcement behind the finished wall **required.**

Important Disclaimers:

- Please read Installation Manual thoroughly prior to installing this product.
- Please note that you should consult your local building codes with questions on installation compliance standards. Building and plumbing codes may vary by location, and DreamLine® is not responsible for code compliance standards for your project and will not accept any returns.

For commercial customers, we strongly recommend the use of Dreamline's Onsite Contractor Support option.

Dreamline's commercial warranty does not apply to damage or losses resulting from (i) other than normal and proper use and normal service conditions; (ii) improper installation, (iii) installation in or upon an unsuitable surface or areas; (iv) abuse, (v) accident, (vi) alteration, (vii) misuse, (viii) neglect, (ix) unauthorized repair or the failure to utilize suitably qualified and trained persons to perform service and/or repair of the Product, (x) improper maintenance, (xi) failure to follow installation, operating, cleaning or maintenance instructions, and (xii) use of "non-authorized" parts.