

# 9230248 10x10 Norwood MOSQUITO MESH KIT LOADING DIAGRAM

(44 sets/pallet A, 50 sets/pallet B, 40 sets/pallet C, 55 sets/pallet D,  
total 14 Pallet A, 1 Pallet B, 14 Pallet C, 1 Pallet D, 1281sets, gross weight: 14731Kg)

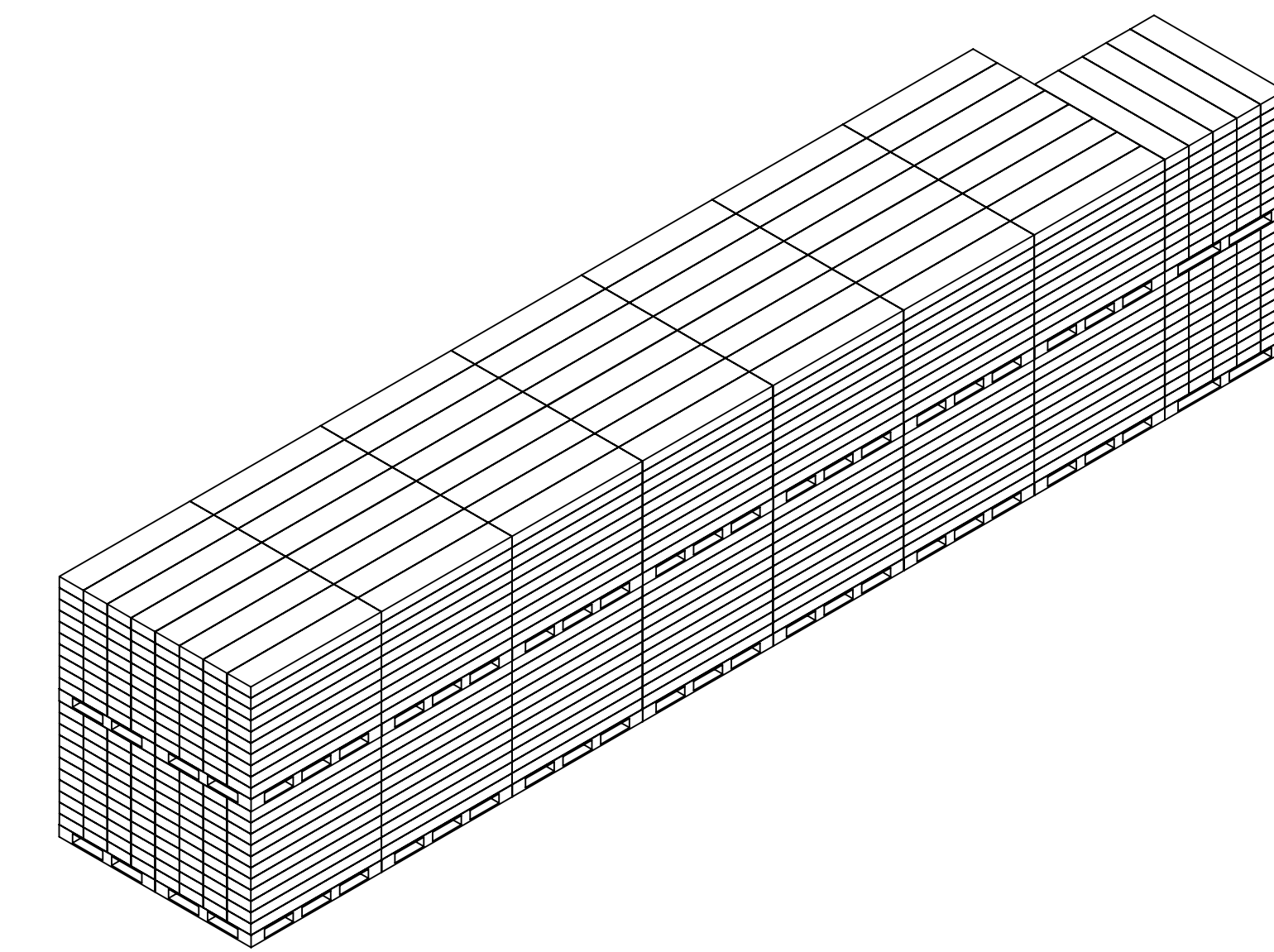
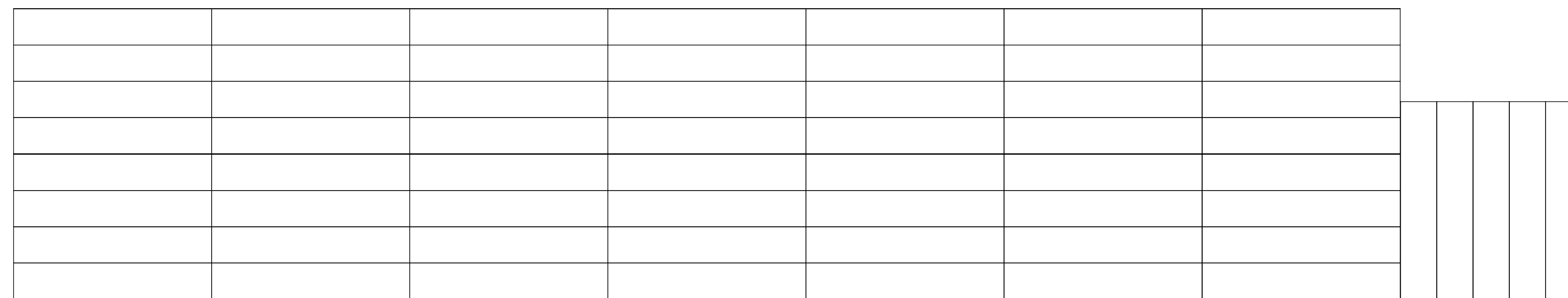
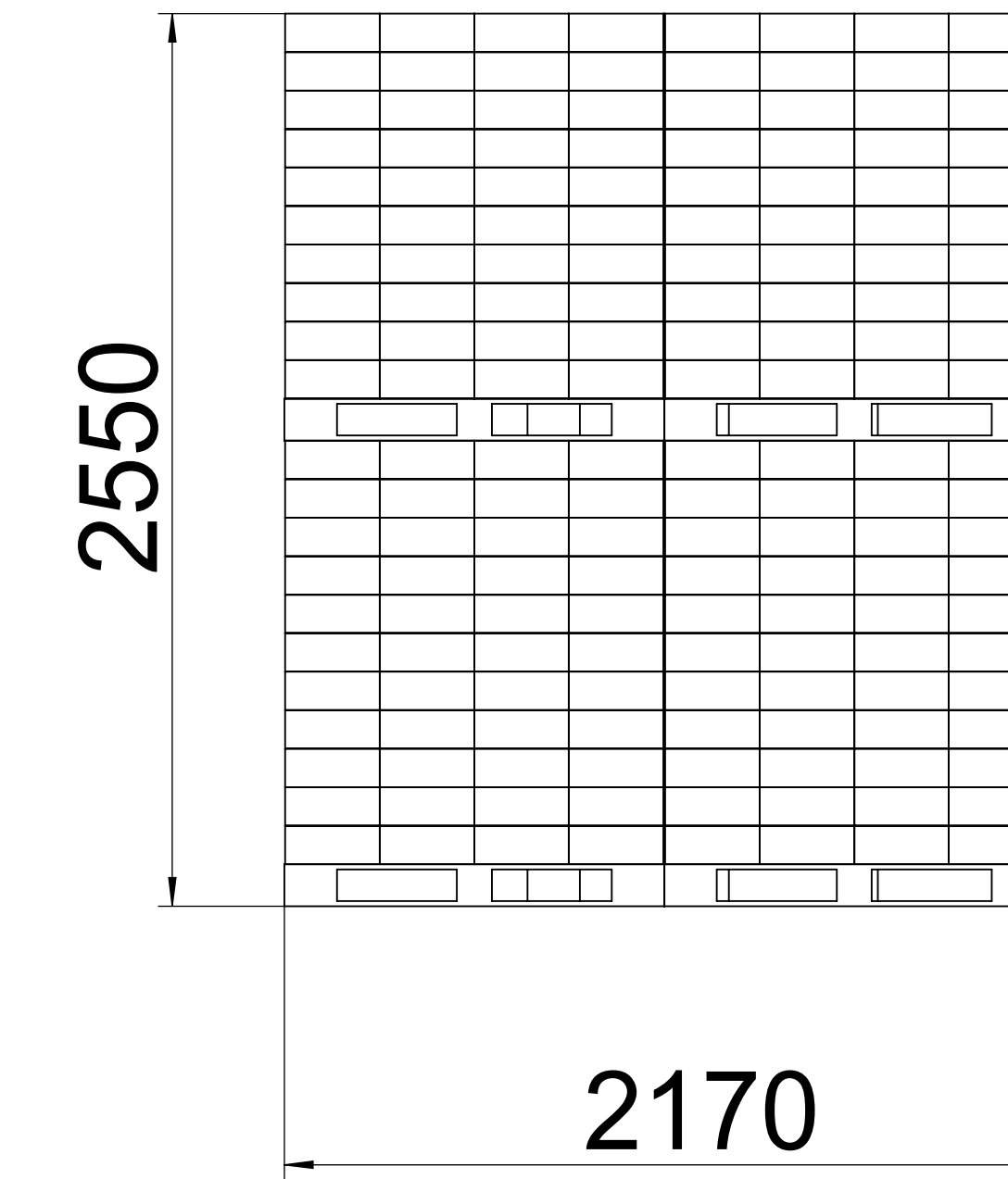
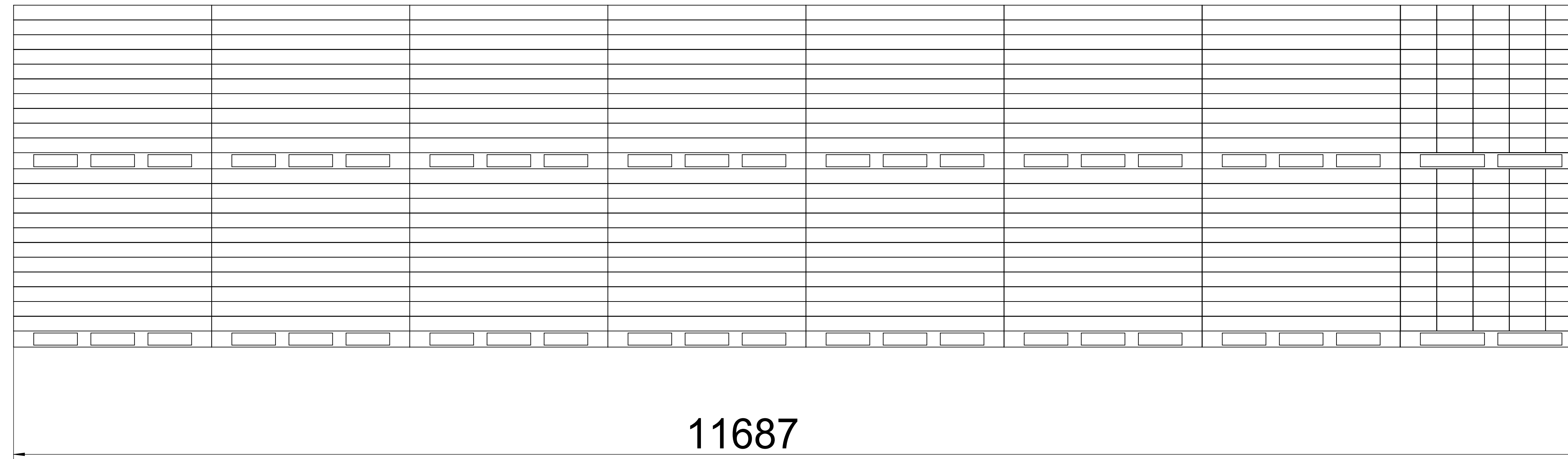

零件代号  
量(制)件号  
插图  
插表  
最高层号  
底面点号  
英寸

# Pallet A Details, 44 sets/pallet

A

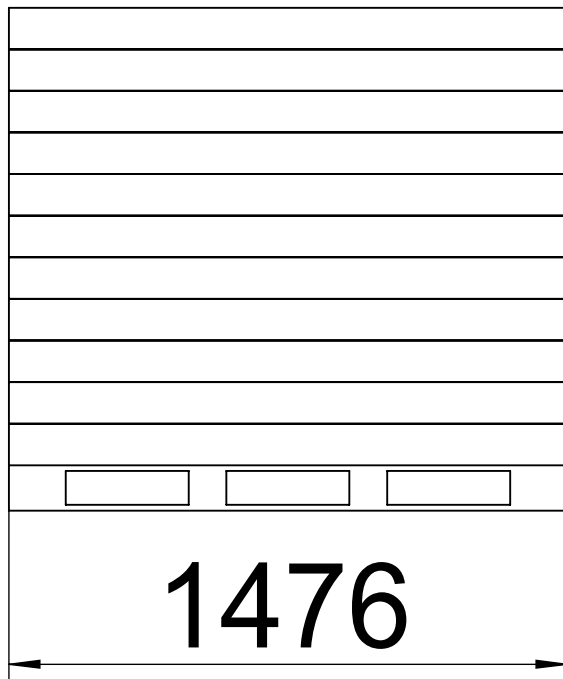

1330

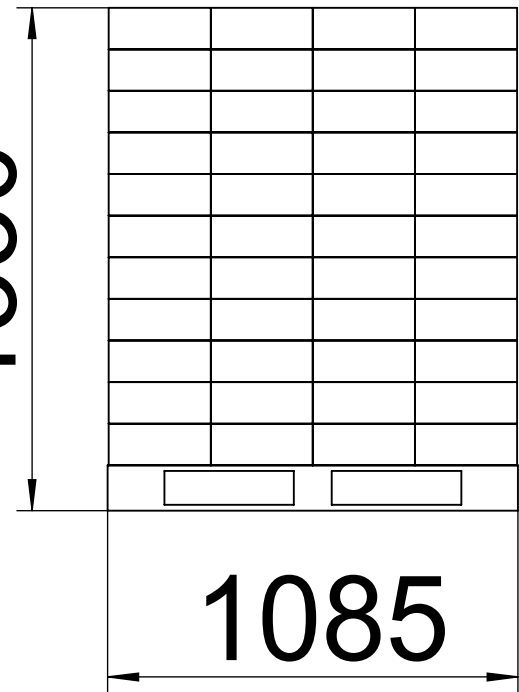

1085

B

B

C

C

D

D

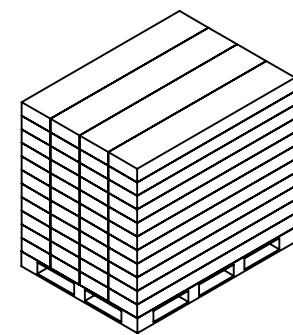

1

2

3

4

5

6

1

2

3

4

5

6

# Pallet B Details, 50 sets/pallet

A



1476



B

1220

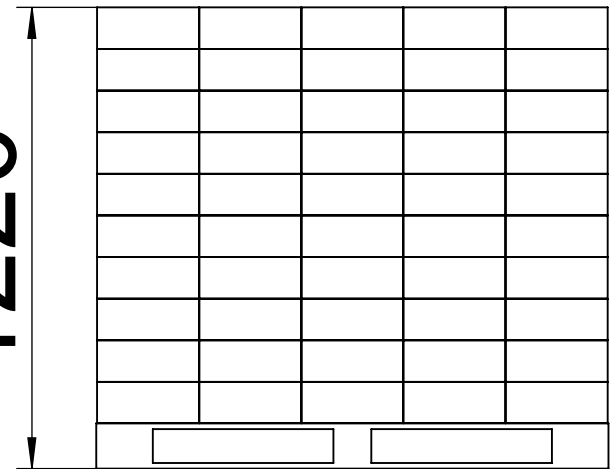

1355



A

B

C

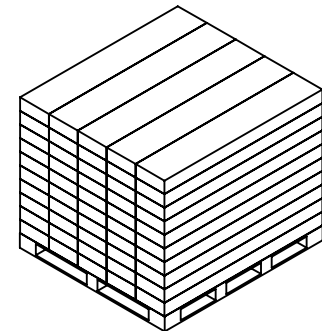

C

D

D

1

2

3

4

5

6

1

2

3

4

5

6

# Pallet C Details, 40 sets/pallet

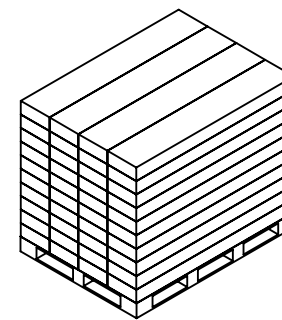
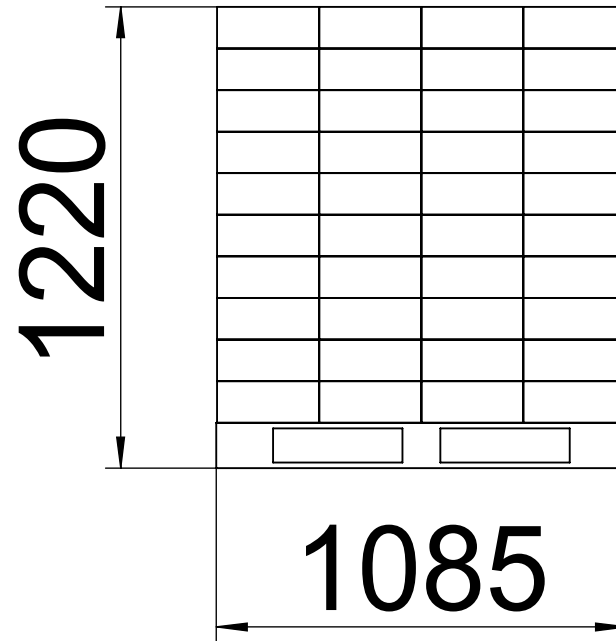
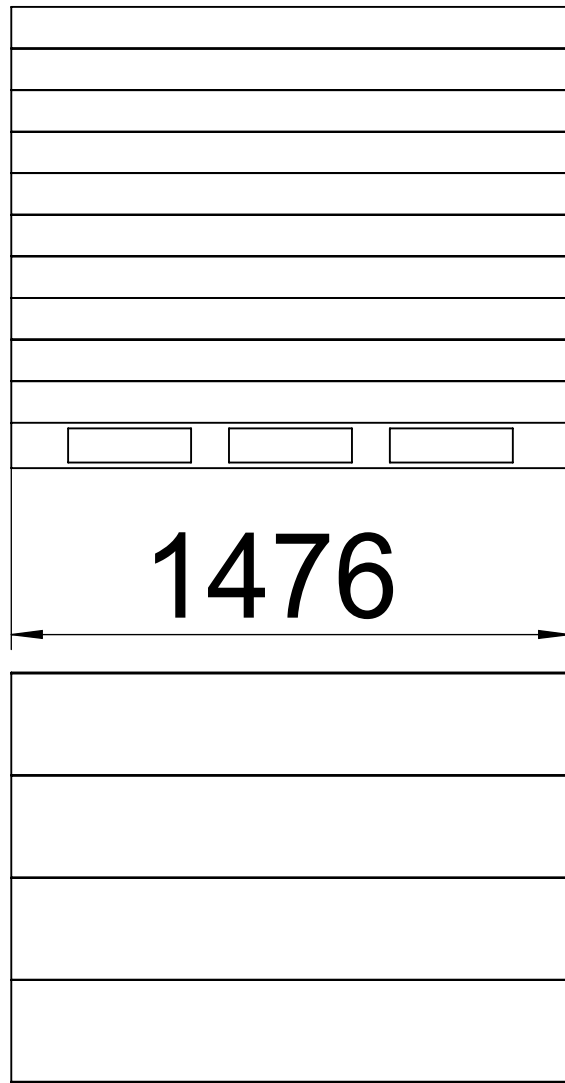

# Pallet D Details, 55 sets/pallet

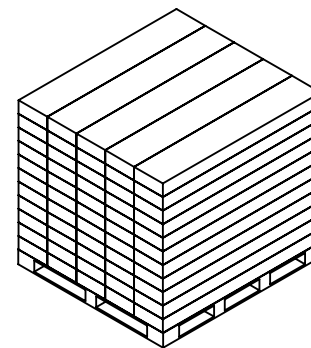
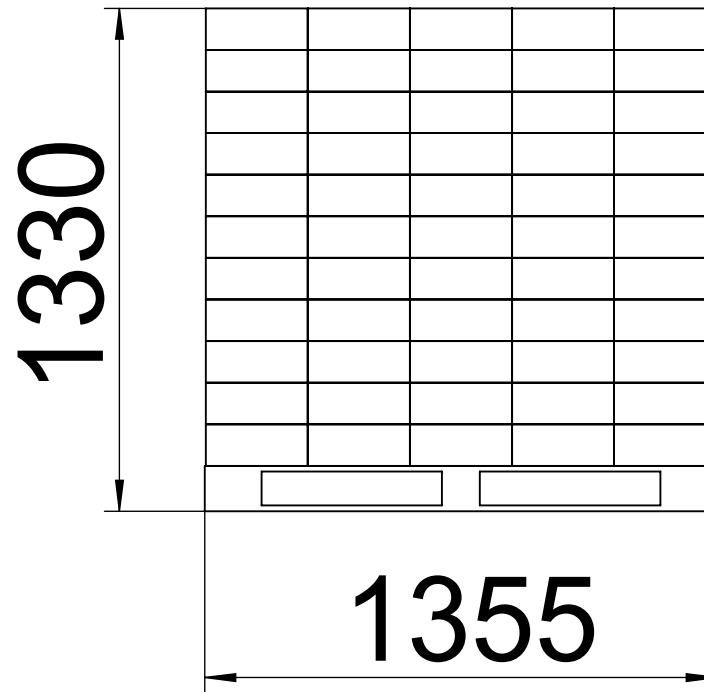
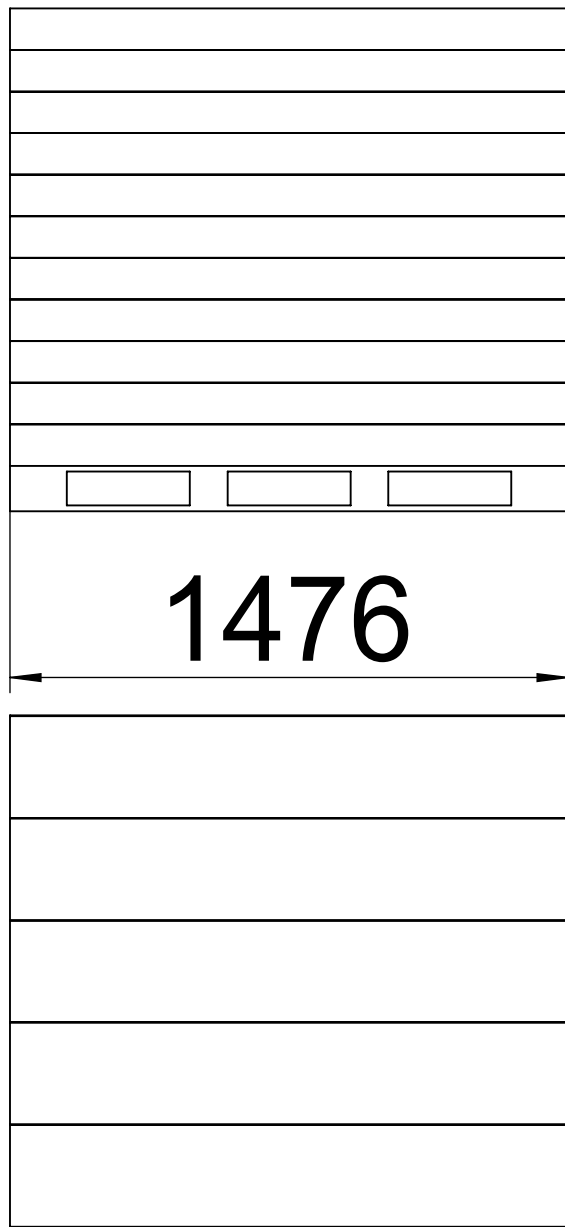

# Carton Details

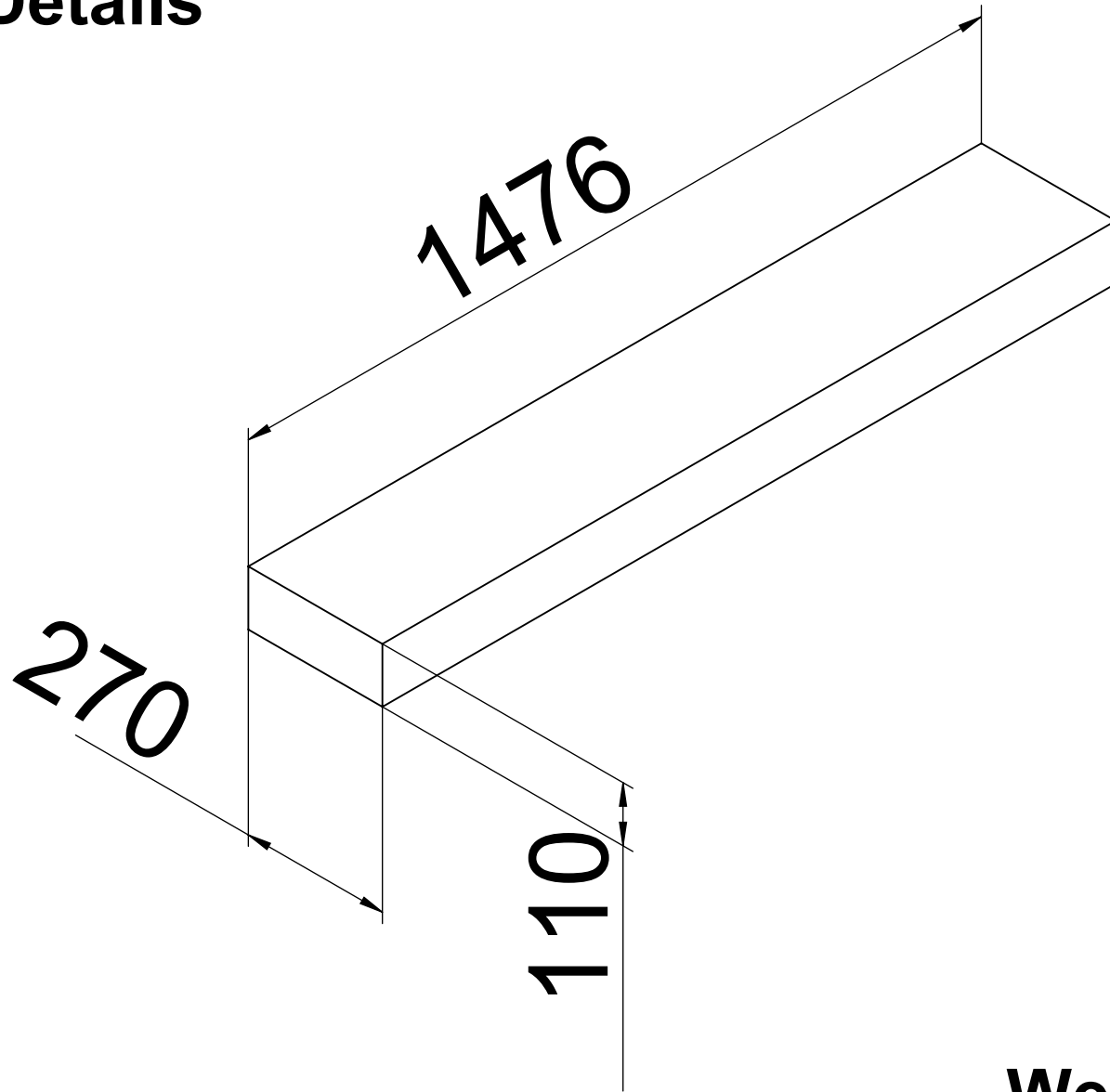

**Weight: 11.5 Kg**