

Thank you for your purchase!

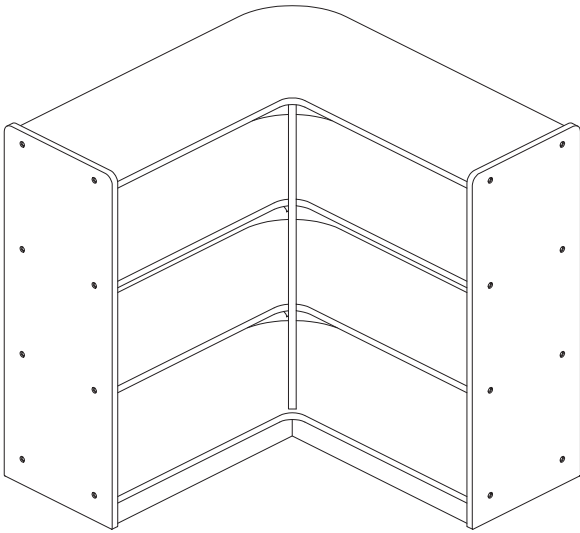

Hercules Modular Wooden Classroom 3 Tier
Open Corner Storage Unit - Commercial Grade

ASSEMBLY INSTRUCTIONS

Before You Begin: Phillips screwdriver (not included) required for assembly

Please identify all component parts and hardware pieces required before you begin. Carefully remove all of the components from the packaging and set aside for assembly. Assemble on a soft surface to prevent scratching during assembly. Phillips screwdriver required for assembly (Not Included).

Caution:

Tighten all components securely before use. Failure to do so may result in personal injury. DO NOT use any sharp objects to open plastic wrapped components as damage to product or components may result.

⚠ Warning:

Tighten all components securely before use. Failure to do so may result in personal injury. DO NOT use any sharp objects to open plastic wrapped components as damage to product or components may result.

CHOKING HAZARD - Small Parts. Adult Assembly Required.

DO NOT ALLOW CHILDREN TO CLIMB ON FURNITURE.

The tipping restraint is intended only as a safety measure, it is not a substitute for proper adult supervision.

Serious or fatal injuries can occur from furniture tipping over. You must install Tipping Restraint Hardware (where included) to help prevent the unit from tipping and causing accidental injury, instability, death or damage. The tipping restraint is intended only as a safety measure, it is not a substitute for proper adult supervision.

To help prevent furniture from tipping over it must be permanently attached to the wall. Anti-Tip Safety Wall Straps suitable for the unit weight and wall materials (if not included) should be purchased and installed.

Customer Service Email: CustomerExperience@belnick.com | Phone: 866-552-2810

MK-KE24053-GG

⚠ WARNING:

Adult assembly required. This item contains small parts that have sharp points and edges in the unassembled state. Adults must be extra careful to securely tighten all screws, make sure the item is properly assembled, and ensure there are no left-over metal parts (eg. Allen key) within reach of children.

⚠ WARNING:

CHOKING HAZARD - Small Parts.
Not for children under 3 years.





Congratulations!

You just purchased a piece of happiness. At Belnick, we believe you can transform your spaces into the most inspired places with furnishings that are the perfect combination of form, function and style. As original innovators of online furniture retail, we offer the best selection of popular, contemporary styles at cool, comfortable prices. And, with decades of proven shipping and packaging expertise, our Extended Quality Checklist ensures a rewarding, hassle-free experience time and time again. It's just what you need to bring your vision to life.

Thank you & Enjoy!!

your friends at Belnick



LIKE IT!

*Share it on social
& Tell a friend!
#Spaces2Places*



LOVE IT!

*Write an online
product review
where purchased*



NOT SURE?

*Let us help!
Contact our
customer support.*

Have a question, concern or simply need a hand? Your satisfaction is our top priority. Contact us at 866-552-2810 or customerexperience@belnick.com. We're here to help!

Browse Our Branded Collections

There's something for everyone inside our family of brands.

FLASH
FURNITURE®



MERRICK | LANE

Emma+Oliver®

TAYLOR + LOGAN

BlackArc®



Visit www.belnick.com/brands or scan this code to go even faster!

BELNICK

ONE VISION. ENDLESS POSSIBILITIES.



We pride ourselves on providing an excellent customer experience starting right here with your package and instructions. Everything you need should be right where you need it, so you can get to enjoying your new item ASAP. But despite our best efforts, sometimes "slips happen." If you need any support, from replacement parts to recommendations, please reach out to our wonderful customer support team at 866-552-2810 or customerexperience@belnick.com. We're here to help!

EVERY BELNICK PRODUCT



Quality &
Durability Tested



Packaged
with Care



Shipped from
our U.S. Facility



Designed
for Easy
Assembly



Ethically
Sourced

Please visit <https://www.belnick.com/warranty> for complete warranty information.

Read this manual before using this product. Failure to follow the instructions and safety precautions in this manual can result in serious injury or death. Keep this manual in a safe location for future reference.

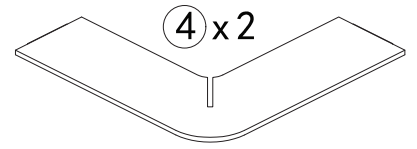
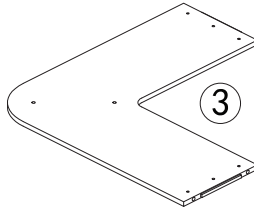
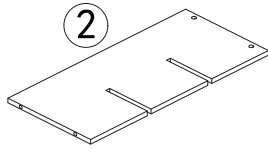
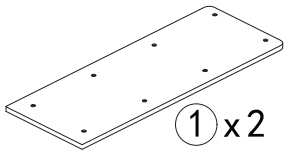

220927

Tool Required

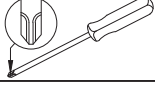

Accessories Included:

M6 x 7 L42

d15 x 12

M7 x 48



A x 2

B x 2

C x 18

M4 x 50

M4 x 12

ALLEN KEY 4

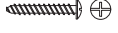

D x 19

E x 28

F x 1

