



*Center Drain Base in White Finish Shown

SLIMLINE

Specification Features

- MODEL SIZE: 36 IN. D X 42 IN. W X 2 3/4 IN. H
- BASE TYPE: SINGLE THRESHOLD (3-WALL ALCOVE)
- LOW PROFILE THRESHOLD FOR EASY ENTRY AND EXIT
- SLIP-RESISTANT TEXTURED FLOOR FOR SAFE SHOWERING
- DURABLE CONSTRUCTION. REINFORCED WITH FIBERGLASS
- GLOSSY ACRYLIC FINISH. SCRATCH AND STAIN RESISTANT
- MADE FOR 3-WALL, ALCOVE INSTALLATION
- DRAIN NOT INCLUDED



Technical Information

- Model: SlimLine
- Shower Base Type: Single Threshold
- Shower Base Shape: Rectangular
- Dimensions: 36" D x 42" W x 2-3/4" H
- Product Width: 42"
- Product Depth: 36"
- Product Height: 2-3/4"
- Color: White
- Drain Location: Center

Codes/Standards Applicable

- cUPC certified

Shower Base Finish Options

-  N/A - White
-  22 - Biscuit
-  88 - Black

Model SKU#: DLT-1136420

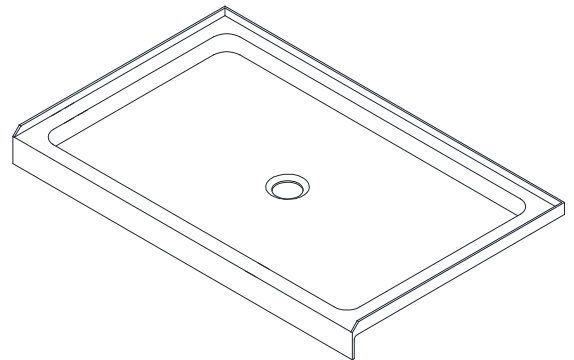

Available Product Variations



*Biscuit Base

Model #s:

DLT-1136420-22



*Black Base

Model #s:

DLT-1136420-88

Important Notes

DreamLine SlimLine Shower Base dimensions are provided for rough opening measurement (against the studs), while DreamLine Shower Door dimensions are for finished opening measurement.

Make sure that prior to the installation the installation surface is leveled and solid and will be able to support the total weight of the unit. Also make sure the walls are at right angles. While some adjustment in leveling of the tray is possible, irregular installation surface level or improper angle of side walls will result in serious problems for your installation.

Install all of the required plumbing and drainage before installing the shower base. Use a competent and licensed plumber for all plumbing installation.

Drain not included with this product. The drain opening is 3-3/8" in diameter and accepts a standard 2" compression fitted drain.

Important Disclaimers

- DreamLine Shower Bases will always be larger (approximately 2 in. or 51mm) than the corresponding DreamLine Shower Doors. Please, take this information under advisement when ordering your Shower Base and Shower Door separately.
- Please read Installation Manual thoroughly prior to installing this product.
- Please note that you should consult your local building codes with questions on installation compliance standards. Building and plumbing codes may vary by location, and DreamLine® is not responsible for code compliance standards for your project and will not accept any returns.