

2404144 Lancaster L-Shape Kitchen Container 2 Loading Diagram

Box#1 4 pallets, total 28 boxes

Box#3 6 pallets, total 18 boxes

Marble 27 crates

Pizza Oven: 2 pallets, total 24 units

Fridge: 42 units

Gross weight : 14650 Kg

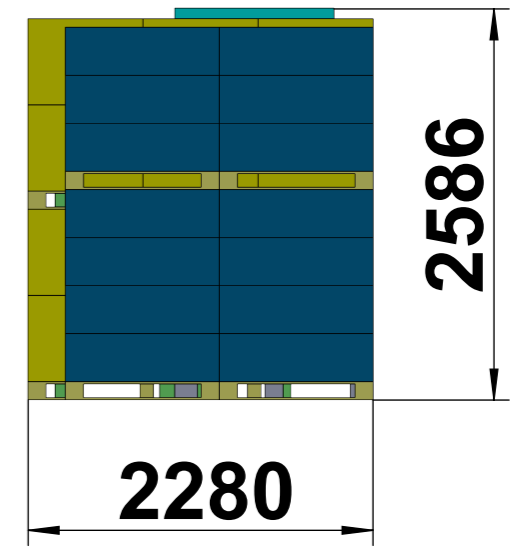
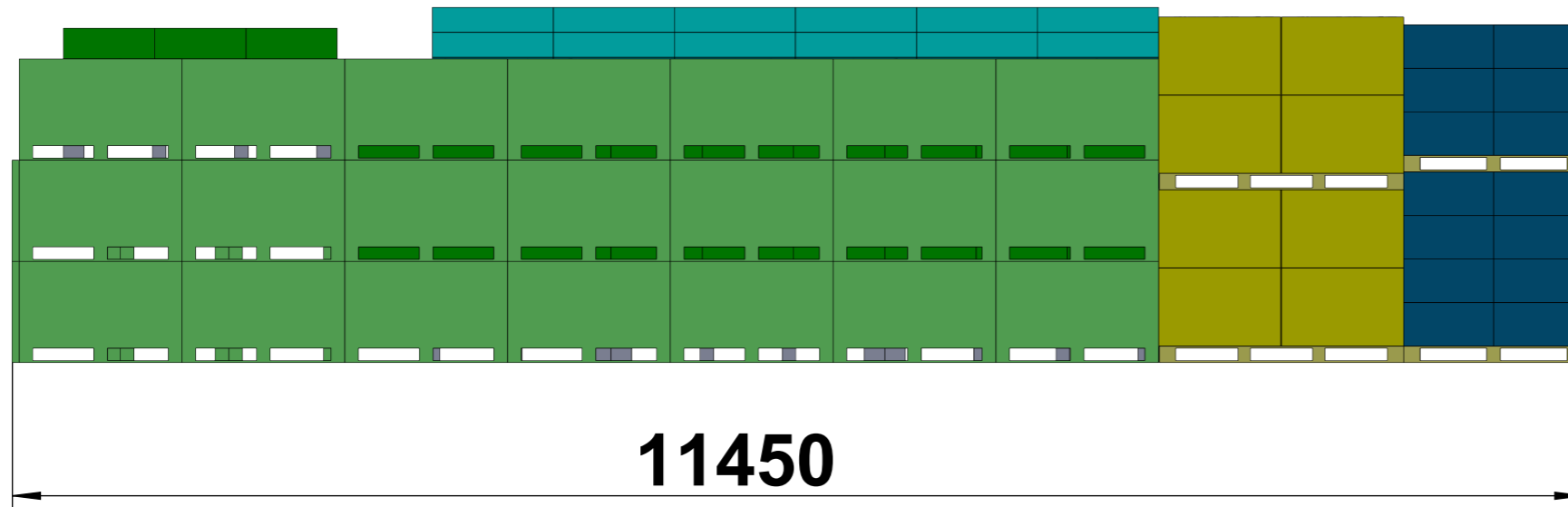
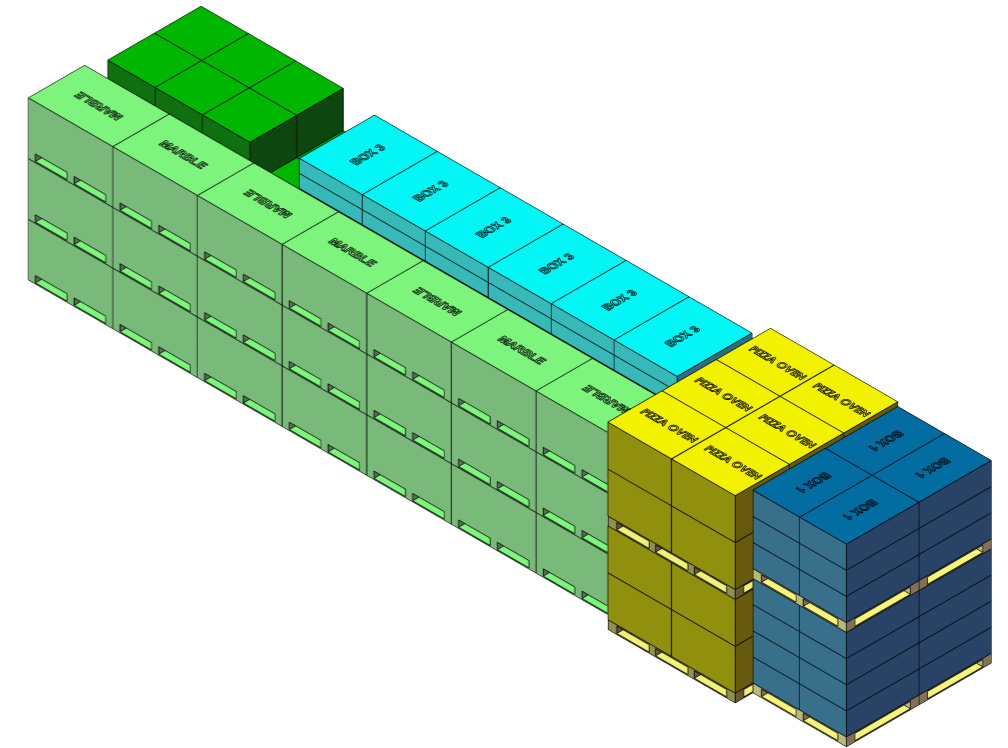

BOX 1 Pallet Details

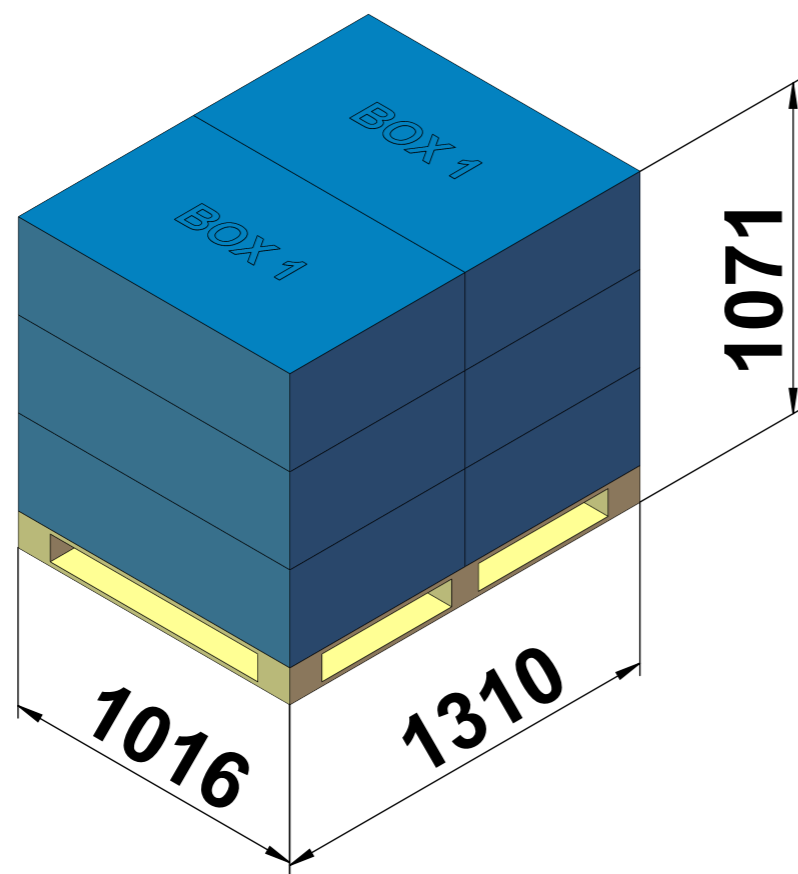

6 boxes/pallet A
2 pallets

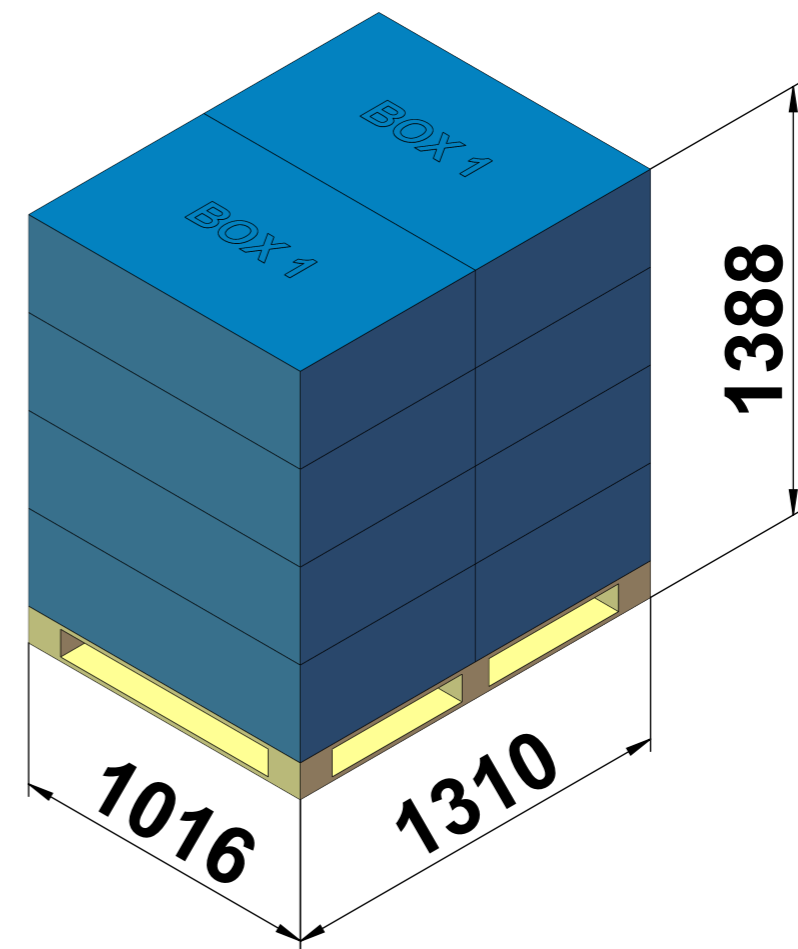

8 boxes/pallet B
2 pallets

BOX3 Pallet Details

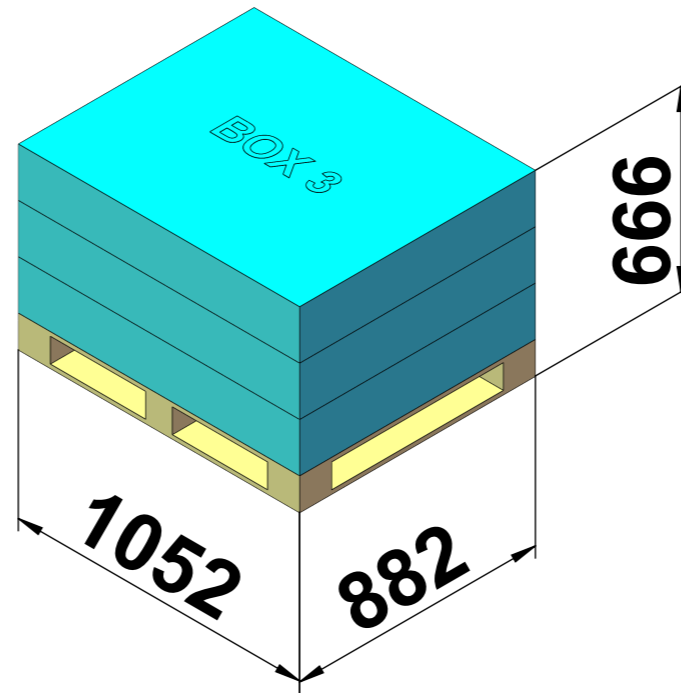

3 boxes/pallet
6 pallets

Fridge Pallet Details

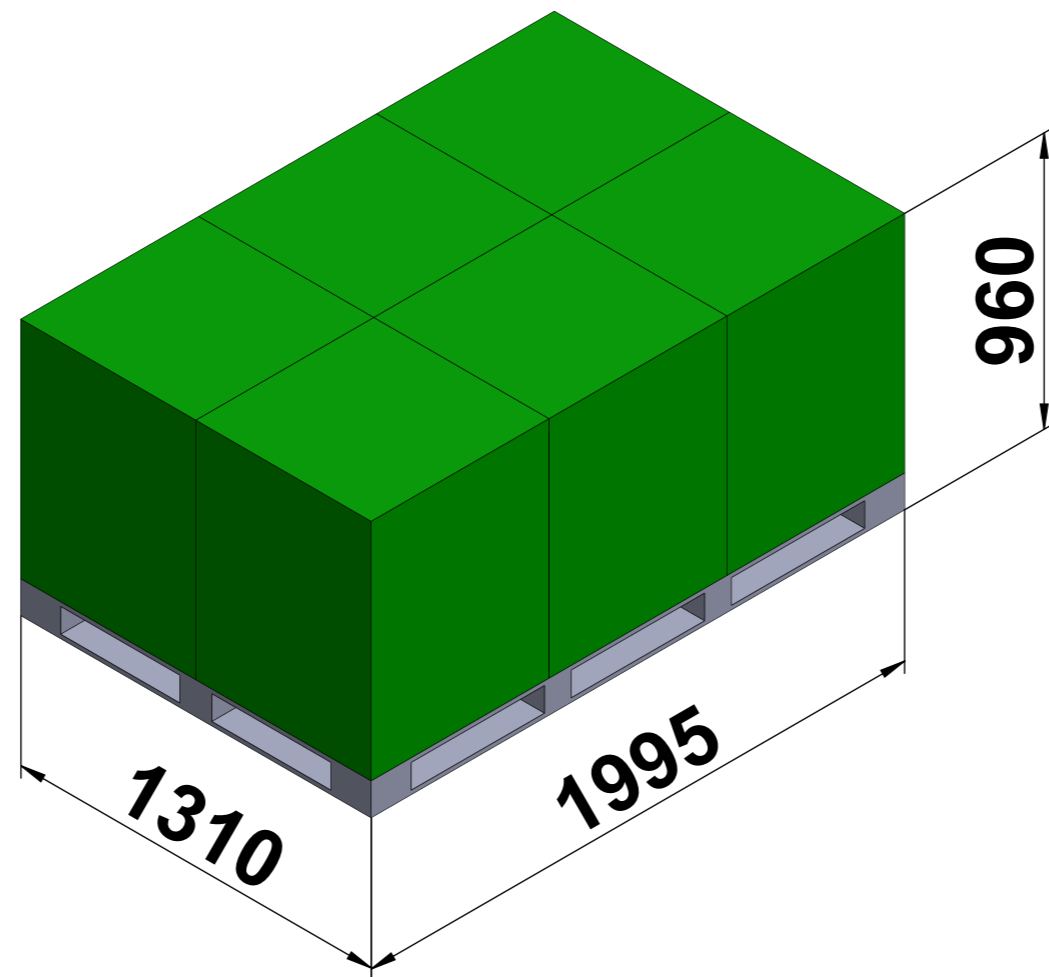

6 fridges/pallet
7 pallets

Pizza Oven Pallet Details

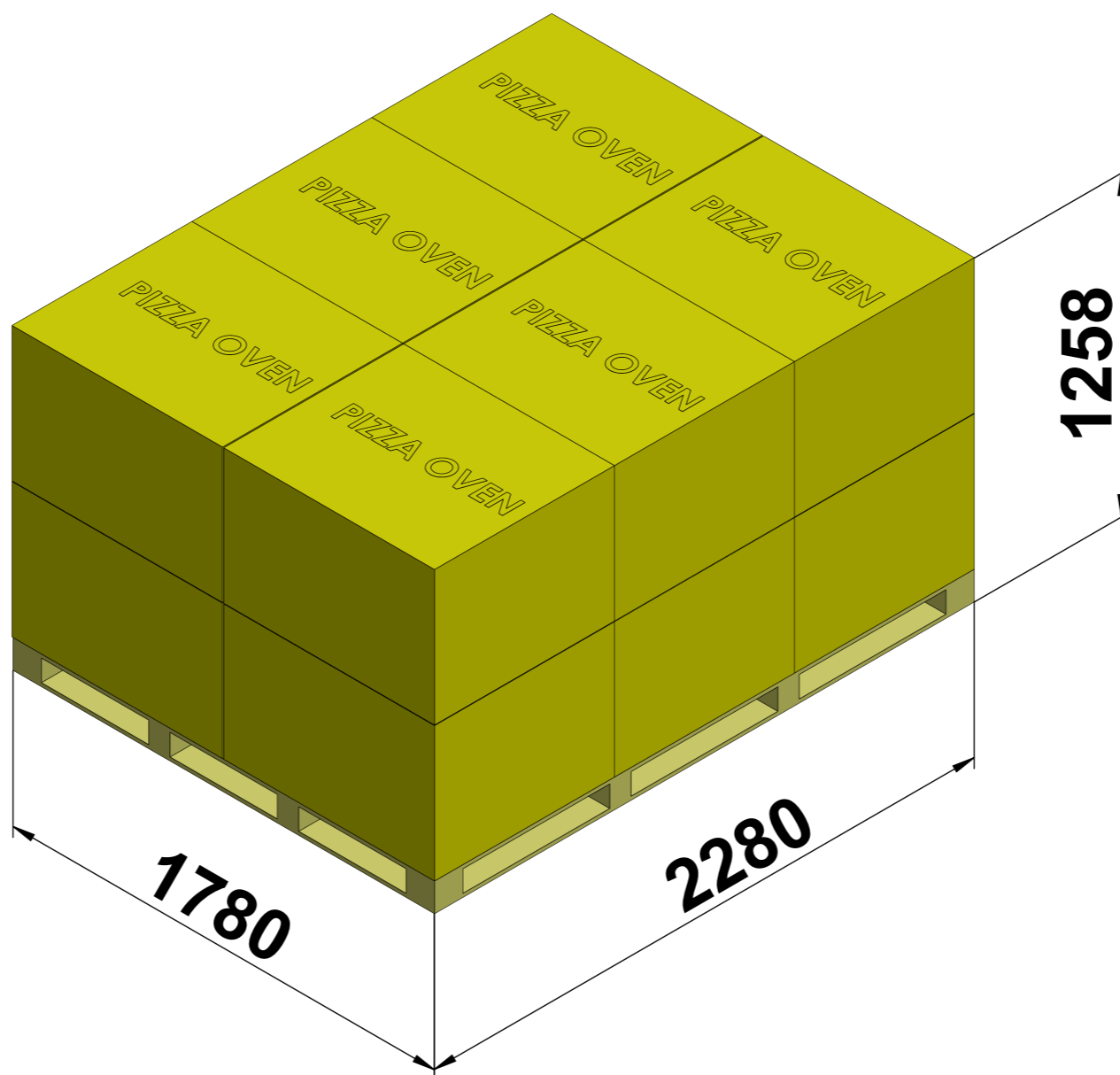

12 boxes/pallet
2 pallets

BOX details

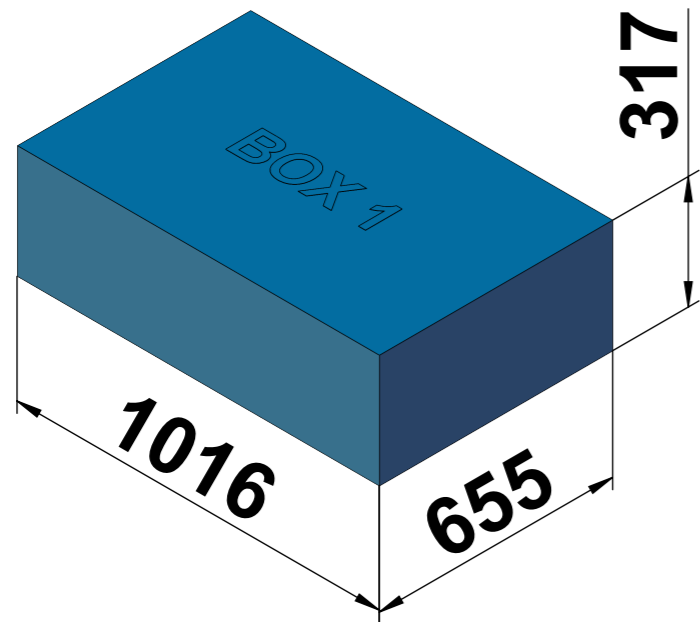

BOX 1 65 Kg

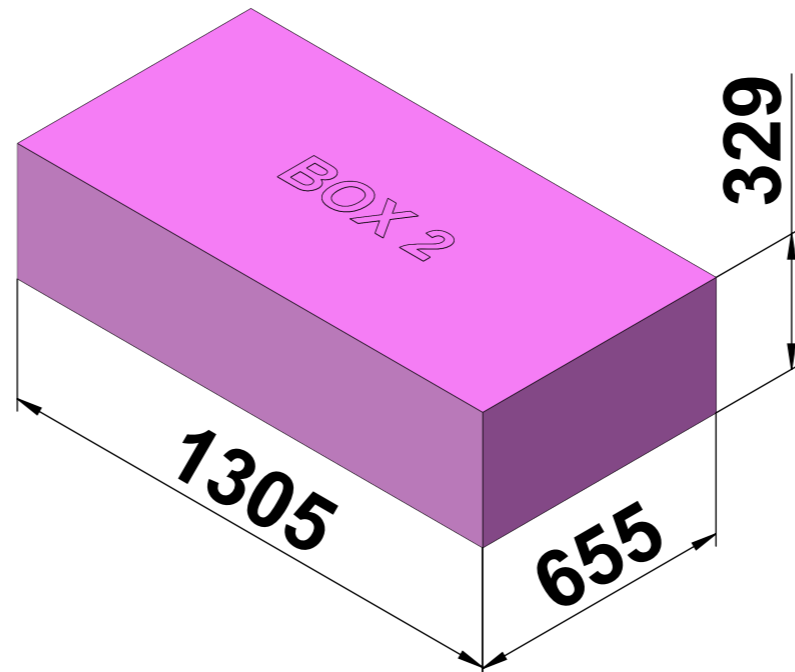

BOX 2 60 Kg

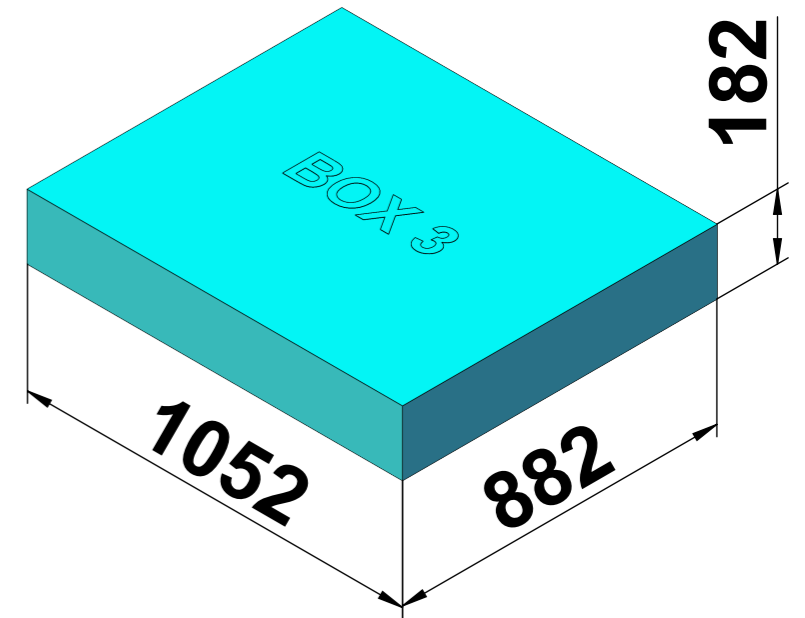

BOX 3 70 Kg

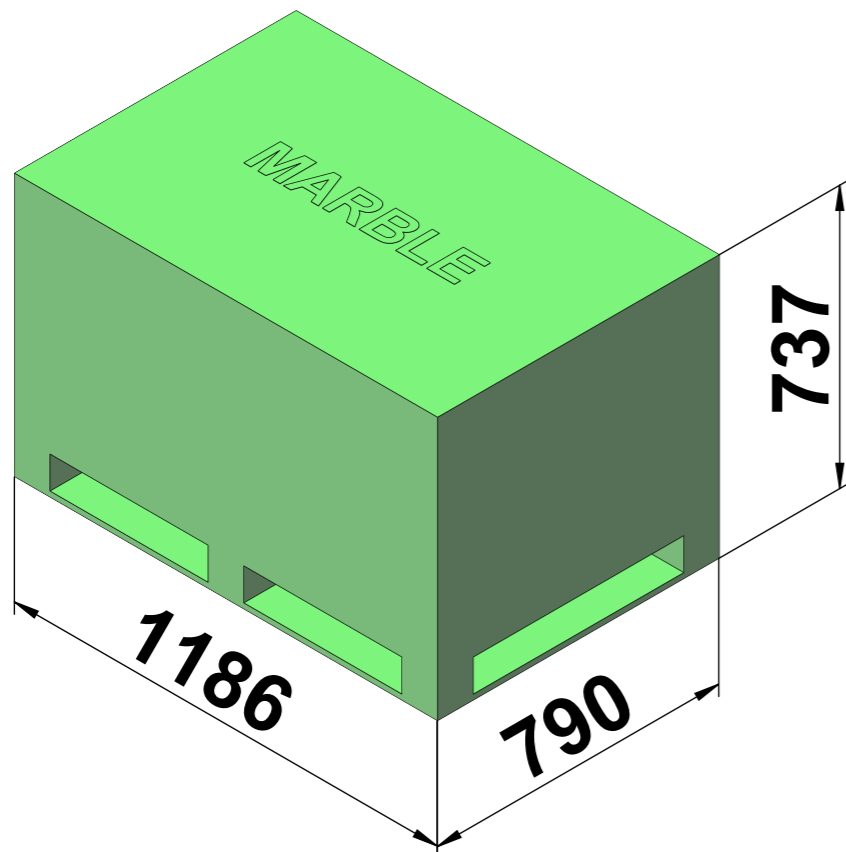

BOX 4 180 Kg

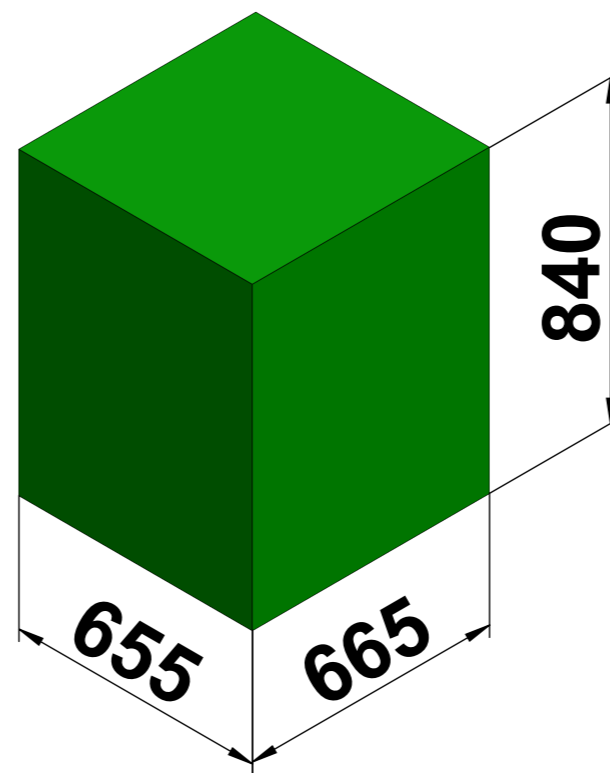

Fridge 80 Kg

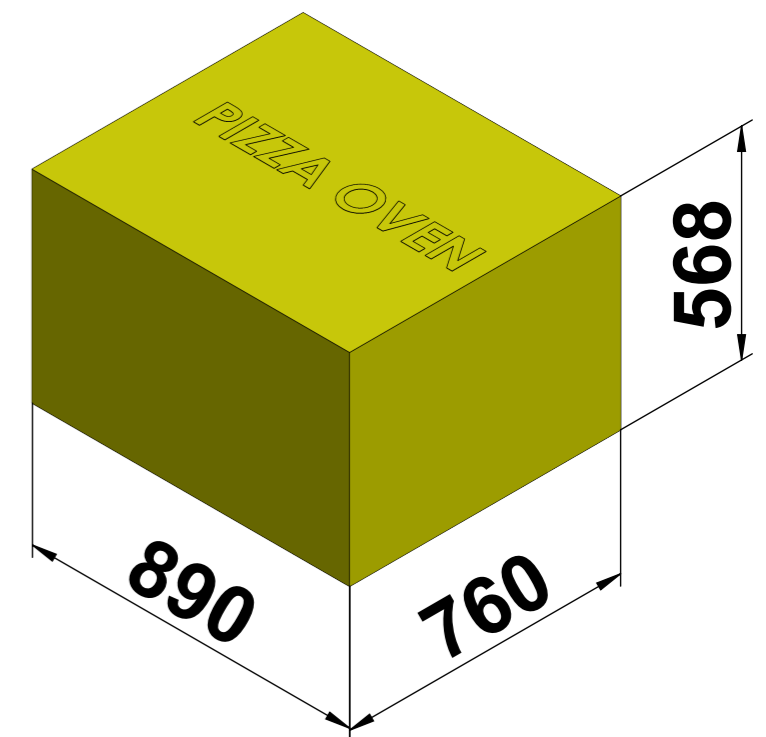

Pizza Oven 100 Kg