



Fall Protection

# Product Catalogue

# In safe hands.

3M Fall Protection, part of the 3M Personal Safety Division, has earned a reputation as the experts in safe working at height with our market innovations and high-performance fall protection and rescue solutions.

Having been innovating in height safety solutions for over 70 years, we're now more equipped than ever to continue investing in technology, products and training solutions that enhance safety, productivity and comfort for workers at height, through our DBI-SALA® and Protecta® brands.

We're elevating safety and comfort to new heights. The sky's the limit!



## The ultimate in fall protection.

For over 75 years, at-height workers around the world have trusted DBI-SALA® products to help them get the job done well and to get home safely. Today, 3M Fall Protection carries on that proud tradition, delivering premium quality DBI-SALA® fall protection solutions that enable workers to do their best work safely and comfortably.



## Trusted fall protection.

Every at-height worker deserves to be safe, no matter the size or nature of the job. That's why Protecta® has become the go-to choice for safety managers looking for reliable fall protection solutions that comply with safety regulations and help their workers get the job done.

## Contents.

3M™ DBI-SALA® Fall Arrest Harnesses & Accessories	16-29
3M™ Protecta® Fall Arrest Harnesses and Accessories	30-41
3M™ DBI-SALA® Lanyards	44-48
3M™ Hooks & Carabiners	49
3M™ Protecta® Lanyards	50-54
3M™ Protecta® Rope Grabs and rope	55-57
3M™ DBI-SALA® Self-retracting Lifelines	60-79
3M™ Protecta® Self-retracting Lifelines	80-83
3M™ Rescue Systems	84-87
3M™ DBI-SALA® Confined Space Solutions	88-99
3M™ DBI-SALA® Height Access Systems	100-103
3M™ DBI-SALA® Anchors	104-106
3M™ Protecta® Anchors	107
3M™ Horizontal Lifeline Systems	108-109
3M™ DBI-SALA® Vertical Lifeline Systems	110-113
3M™ Protecta® Vertical Lifeline Systems	114-117
3M™ DBI-SALA® Fall Protection for Tools	118-121





# ABCs of fall protection.

A typical Personal Fall Arrest System (PFAS) incorporates key components often described as the ABCs of fall protection.

The (A) anchorage/anchorage connector, (B) body support and (C) connecting device - when used together - form a complete system for maximum worker protection. But don't forget the other important components of a comprehensive fall protection programme: (D) descent and rescue, (E) education and (F) fall protection for tools.

## A

### Anchorage

Anchorage is a secure point of attachment. Anchorage connectors vary by industry, job, type of installation and structure. They must be able to hold fast under the load of a fall, working in suspension or a rescue.



## B

### Body support

Harnesses distribute fall forces over the upper thighs, pelvis, chest and shoulders. They provide a connection point on the worker for the personal fall protection system.



## C

### Connecting devices

Products such as shock absorbing lanyards or self-retracting lifelines connect a worker's harness to the anchorage.



## D

### Descent and rescue

Descent and rescue devices are used to raise or lower a fallen worker to safety, or to retrieve him from a confined space.

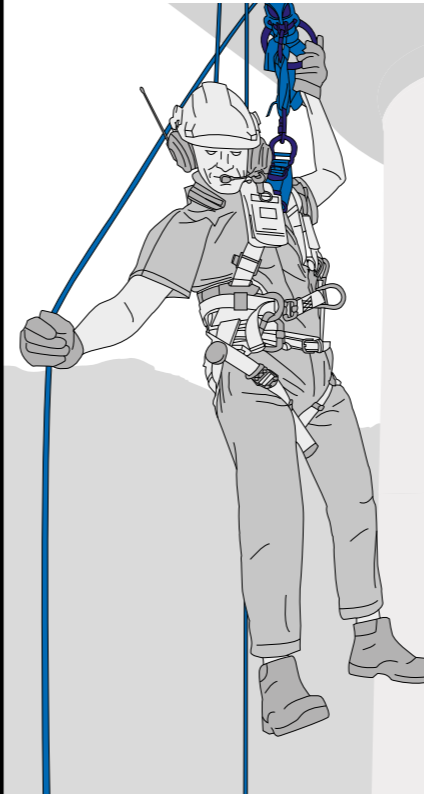

## E

### Education

We offer a variety of best-in-class certified training courses for work at height and confined spaces at our state-of-the-art training centres located around the world. We can also bring training to your workforce with our specialised demonstration vehicle providing an excellent introduction to fall protection.



## F

### Fall protection for tools

Helps make work environments safer and more productive by reducing dropped object incidents.

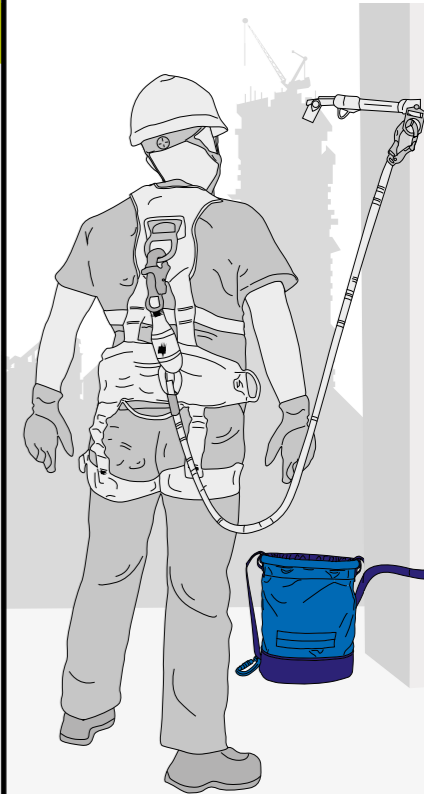

# We've worked in your industry for decades.

At 3M™ Fall Protection, we work hard to understand the challenges you face before we design your equipment. That's how we go beyond compliance to produce a broad and innovative range of high quality fall protection equipment for the world's most vital industries.



## Wind energy

To address safety needs in this growing industry, we created specialised 3M™ DBI-SALA® ExoFit NEX™ Wind Energy Harnesses and 3M™ DBI-SALA® EZ Stop™ Lanyards, as well as rescue and escape systems such as the 3M™ DBI-SALA® Rollgliss™ R550 Rescue and Descent Device.



## Transportation

We developed dozens of specialised products, from DBI-SALA® Horizontal Systems for rail-car loading, to custom access 3M™ DBI-SALA® FlexiGuard™ Solutions for truck servicing. We've even designed a patented fall arrested 3M™ DBI-SALA® Self-Contained Vacuum Anchor System for aviation workers.



## Oil & Gas

We pioneered "retractable" lifeline technology in the 1940s, "sealed retractable" technology specifically for the oil and gas fields, and products tested to -40°C to meet the IP69k seal rating. In addition, we developed specialised equipment and training for a wide array of emergency escape devices.



## Utilities and telecoms

We proactively innovate equipment specifically for these industries, such as our 3M™ DBI-SALA® Lad-Saf™ and 3M™ Protecta® Cabloc™ permanent vertical lifeline systems. Our welding and hot works products feature Kevlar®/Nomex® fibres for your safety and peace of mind. In addition we offer a number of innovative rescue and descent systems and kits, crucial to your rescue plan.



## Construction

No two construction sites are the same. That complexity is why we work closely with contractors to help us fine-tune our design on key products such as the 3M™ DBI-SALA® Nano-Lok™ Edge Self-Retracting Lifeline—used at sites where sharp edges are hazardous and foot level tie-off is needed.

We listened to steel erectors and created shoulder caps that protect the webbing on our latest harnesses. Our 3M™ DBI-SALA® EZ-Line™ Horizontal Lifeline System is extremely user-friendly and features an innovative retractable design.



## Manufacturing and chemical

Every day, thousands of manufacturing and facility workers around the world don their safety gear and head out to do their job. Whether you're processing, milling, finishing, inspecting or doing routine maintenance, 3M™ Fall Protection has you covered. Our specialty Confined Space Equipment, 3M™ DBI-SALA® Nano-Lok™ Edge Self-Retracting Lifelines, 3M™ DBI-SALA® ExoFit NEX™ Harnesses, 3M™ DBI-SALA® Lanyards, 3M™ DBI-SALA® Lad-Saf™ Ladder Safety Systems are just a few of the many solutions we offer.



## Mining

We developed specialised harnesses to address miners' specific needs as well as 3M™ DBI-SALA® FlexiGuard™ Solutions to protect them whilst carrying out maintenance on oversized mining industry trucks. Additionally, our industry-leading mining anchors maximise versatility and ease-of-use for workers.



# On-Site Safety Awareness.



Did you know that 3M™ Fall Protection offer on-site safety awareness direct to your workforce?

We can bring one of our fully equipped Demo Vans to a location on a date to suit you; saving you precious time and resources.

Our hands-on fall protection demonstrations present a whole range of products required for working at heights.

Demonstration topics include:

- Drop Tests - to show the forces workers are subjected to during a fall from height.
- Equipment inspections.
- Rescue - practical demonstrations in a range of worker environments.
- Confined space - practical demonstrations of correct use of tripods and different applications of the winch.
- Understanding lifelines.
- Basic working at height guidelines.



Our demovans are now equipped with the latest Virtual Reality technology, so you can experience a fall from height scenario. A great tool to educate in a safe and controlled environment.

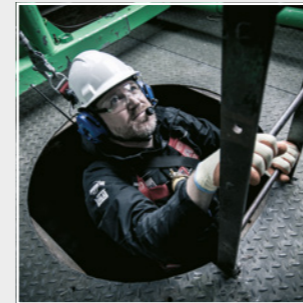

## Safety Training

Workers' lives are on the line every day, but ensuring their safety starts long before the job begins. No one understands this better than 3M™ Fall Protection. Our training is based on more than 70 years of expertise and jobsite implementation around the globe.

When it comes to protecting your work site, we deliver. We offer superior courses in world-class training facilities, based on standard curriculum's or custom programs specific to your jobsite.

Our training services include:

- Regional facilities to avoid extensive delegate travel or ability to facilitate courses at your own sites.
- Ability to build bespoke course programme's to ensure that training meets your specific company requirements.
- Access to and use of the widest range of fall protection equipment to ensure delegates receive a broad training experience.

Our comprehensive training provides practical, hands-on experience across a full range of fall protection training, fall arrest training and industrial rescue courses at our state-of-the-art training centres located across Europe, as well as on-site training customised to your needs.

Visit [www.3M.co.uk/safetytraining](http://www.3M.co.uk/safetytraining) for more information.





## Express Ship.

With more than 5,000 fall protection items available to service a wide variety of applications and end-user requirements, it is simply not practical for us to stock every item. We can however offer an Express Ship option. Distributors can take advantage of this to greatly reduce lead times associated with non-stock items.

An additional fee equal to 3% of the selling price of the item will be applied to the order. We will waive this fee if we are unable to deliver by the quoted delivery date. Express Ship is only available on deliveries to the following countries: UK, France, Germany, Spain, Italy, Netherlands, Belgium.



## Prime Ship.

We carry over 500 of the fastest moving items in our European warehouses. Most items within this catalogue are in stock and ready to ship the same day for orders placed before 14:00 (GMT) / 15:00 CET. Your customer service agent will be able to advise on inventory and any items not available for same day shipping.

## Harness Sizing charts.

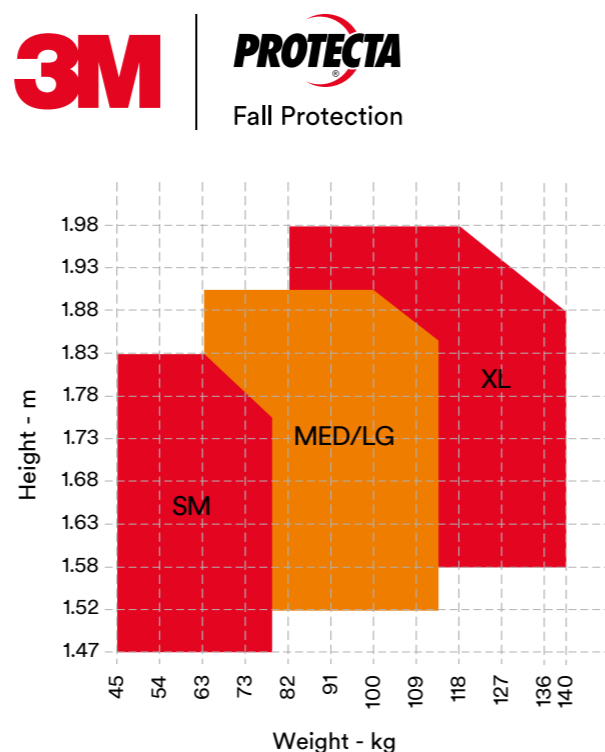
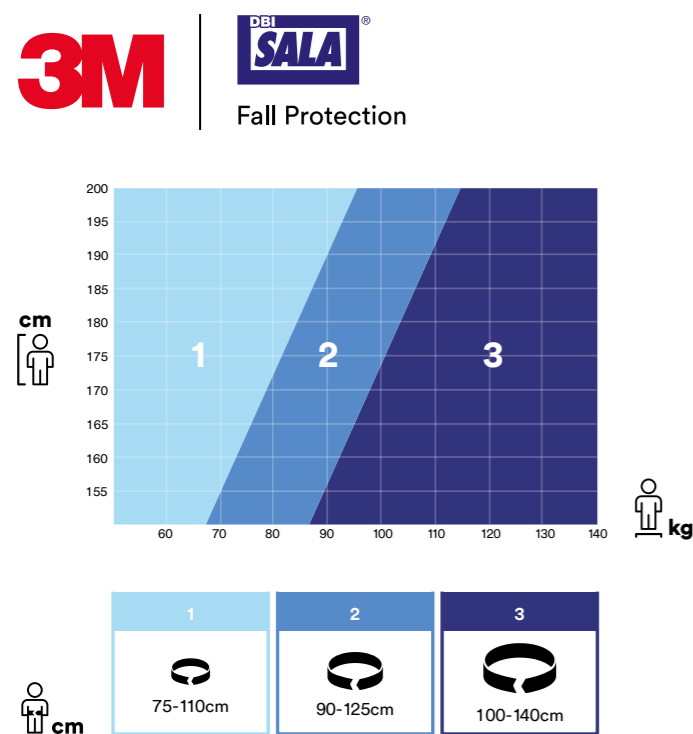

## Certification.

The European Commission has published a certain number of standards intended to control the design and use of rescue and personal protection equipment against falls from height. These standards must be adhered to, and are applicable in all the member states.

### General:

<b>EN</b> 1496	<b>CE</b> EN567	<b>CE</b> EN12841	<b>CE</b> 2016/425	<b>CE</b> 2006/42/EC
Rescue lifting devices	Rope clamps	Rope adjustment devices	PPE Regulation	Machine Directive

### Anchors:

<b>CE</b> EN353-1	<b>CE</b> EN353-2	<b>EN</b> 795 TYPE A	<b>CE</b> EN795 TYPE B	<b>EN</b> 795 TYPE C	<b>CE</b> EN795 TYPE E
Guided type fall arresters including a rigid anchor line	Guided type fall arresters including a flexible anchor line	Anchors fixed to the structure	Anchors not fixed to the structure	Horizontal Lifeline with flexible support	Counterweight anchor

### Harnesses:

<b>CE</b> EN361	<b>CE</b> EN813	<b>EN</b> 1497	<b>CE</b> EN471
Full body harness	Sit harnesses	Rescue harnesses	High-visibility warning clothing

### Connectors:

<b>EN</b> 341	<b>CE</b> EN354	<b>CE</b> EN355	<b>CE</b> EN358	<b>CE</b> EN360	<b>CE</b> EN362
Descender devices	Lanyards	Energy absorbers	Belts and restraint lanyards for work positioning	Retractable type fall arresters	Connectors

## Harness icons.



Chest



Leg



Waist



Pass Through Buckle



Quick Connect Buckle



## Top tip!

Wherever this icon appears, click to find out more information on [3M.com/FallProtection](http://3M.com/FallProtection)

## Just how important is choosing the right harness?

When you're 25 metres off the ground, your harness is more than just your safety connection - it's everything. Your comfort, confidence, productivity and versatility on the job are all directly connected to the quality of its design and craftsmanship.

That's why every 3M™ DBI-SALA® Harness - like 3M™ DBI-SALA® ExoFit™ and 3M™ DBI-SALA® Delta™ - is designed to enhance the quality of your work from every angle. Spring-loaded, stand-up back D-rings that are easier to use. Tangle-free design and revolving torso adjusters optimize fit and mobility.

Whether you work in one industry or many, the majority of our harnesses can be used on a wide variety of jobs. We also manufacture harnesses for specific uses within Construction, Oil and Gas, Transportation, Utilities/Telecommunications and Municipalities and Wind Energy.

The following pages contain both general and specific use harnesses. All harnesses meet CE standards.



## Choosing the right harness.

Look for quality in these features when selecting your harness.



### 1. Dorsal connection

The main fall arrest point is located on the back, positioned between the shoulder blades. Most harnesses would always include a dorsal attachment point.



### 7. Stitching

Quality, high strength thread and specifically designed stitch patterns provide maximum strength and durability. Its sewn-in quality you can trust.



### 2. Webbing

Essential for the durability and safety of the harness, webbing has to be strong enough to endure rough use and exposure to the elements without tearing or fraying. Speciality applications such as welding can benefit from special materials like Nomex®/Kevlar® that offer high temperature resistance.



### 8. Padding

Cushioned shoulder, leg and hip pads keep the pressure off, providing extra worker comfort for long hours of wear. In a fall, they absorb shock and help distribute your weight. They may be built-in to avoid slipping or may be removable.



### 3. Adjusting points

Whether you wear a harness 4 hours a day or 14, it needs to fit correctly for safety and comfort. Harnesses with adjusting points on the legs, waist (belt models), chest and torso allow a better fit.



### 9. Suspension relief straps

Built in, or retrofit, they are quickly deployed by the user in the event of a fall. They provide a web loop allowing the user to stand and relieve some pressure from the legs.



### 4. Leg straps

Depending on worker preference, leg strap fasteners may be available in different styles, including:

- Pass Through Buckle
- Quick Connect Buckle
- Tongue & Grommet Buckle



### 10. Impact indicators

Impact indicators provide immediate notice that the worker and harness have been in a fall. This feature promotes safety and proper inspection.



### 5. Pelvic support

A sub-pelvic strap provides additional support, security and comfort for the user. Properly positioned, it better distributes forces during a fall.



### 11. Lanyard keepers

A lanyard keeper provides a place to park your lanyard when not in use. It prevents tripping and entanglement for enhanced safety and will breakaway, saving the user from potentially high impact forces, due to 'short circuiting' of the absorber.



### 6. Book style labels

Book style labels put product and inspection information at the workers' fingertips. Pages may include sizing, operating instructions, inspection log, warning labels and compliance information. These labels promote quick inspection, compliance and safety.



### 12. Breathable linings

The 3M™ DBI-SALA® ExoFit™ Harness Series of harnesses feature breathable linings that wick moisture away from your body. So you stay dry and comfortable in heat or cold.

# Types of harnesses.

3M™ Fall Protection harnesses are available in different types, with various features, depending on their intended use.



### Multi-purpose harness

This type of harness usually includes multiple attachment points (front and back), which allow work in a variety of situations.



### Work positioning harness

With side D-rings on the hips for positioning and an integral padded belt for additional lumbar support. For use with pole straps or work positioning lanyards allowing hands-free operation.



### Confined entry/retrieval harness

The attachment points located on each shoulder can be used with a specific lanyard or an upright retrieval strap for entry/exit in confined spaces.



### Suspension harness

Typically, this harness has low frontal attachment points for use with descent control devices and rope access equipment.

# Fall protection harness fitting instructions.



### Before starting

Remove all items from your pockets, as during work, or most importantly in the event of a fall, objects in pockets can become trapped between the harness webbing and the wearer's body, potentially causing injury. Always refer to instruction for use supplied with the specific harness, concerning correct fitting and adjusting.



### Step 1. Getting started

Hold harness by back D-Ring, which is often held in place by a D-Ring pad, ensure straps are not twisted.



### Step 2. Shoulder straps

Slip harness over arms and onto shoulders. Ensure all straps are not tangled and hang freely.



### Step 3. Leg strap

Reach between your legs and grasp the leg strap on your left side. Bring the strap up between your legs and connect it with the buckle on the left side (see Buckle Types). Connect the right leg strap using the same procedure.



### Step 4. Chest straps

Attach the chest strap buckle to the corresponding opposite side buckle.



### Step 5. Waist belt (if present)

Attach the waist strap buckle to the corresponding opposite side buckle.



### Step 6. Adjust harness to a snug fit

Adjust torso straps to a snug fit with the Revolving Torso Adjusters. The left and right side should be adjusted to the same length and the front D-ring attachment should be centred on your lower chest, approx. 15 cm down from shoulder.

The front D-Ring on the vest style harness is moved up or down by adjusting the shoulder straps and leg straps. Centre the back D-Ring between your shoulder blades. Note: On applicable models, the back (rear/dorsal) D-Ring can be repositioned up or down on the harness webbing as needed for a correct fit.

Re-adjust leg straps to a snug fit (see Correct leg adjustment). At least 8 cm of webbing must extend past the buckle on the leg straps.

Adjust the waist belt (if present).

### Tidy up

Now the harness is correctly fitted, tidy up the loose ends of webbing, by either sliding the plastic web-tidys to the ends, or tucking the loose webbing under the loops, depending on your harness model.

### You're ready to go!

A properly fitted and adjusted full body harness will effectively distribute impact forces throughout your body and provide appropriate support during suspension and rescue following a fall.



# 3M™ DBI-SALA® ExoFit™ Safety Harnesses

When you work at heights, safety is crucial. That's why 3M™ DBI-SALA® ExoFit™ XE50, XE100 and XE200 fall arrest safety harnesses help your workers reach new heights of productivity and performance whilst keeping them safe and comfortable on every level. With solutions rooted in science, 3M™ DBI-SALA® ExoFit™ harnesses redefine what you should expect from a safety harness.

### Applications



## 3M™ DBI-SALA® ExoFit™ Safety Harnesses

Keep your workforce comfortable in uncomfortable places.

# Engineered for optimal fit, function and efficiency.

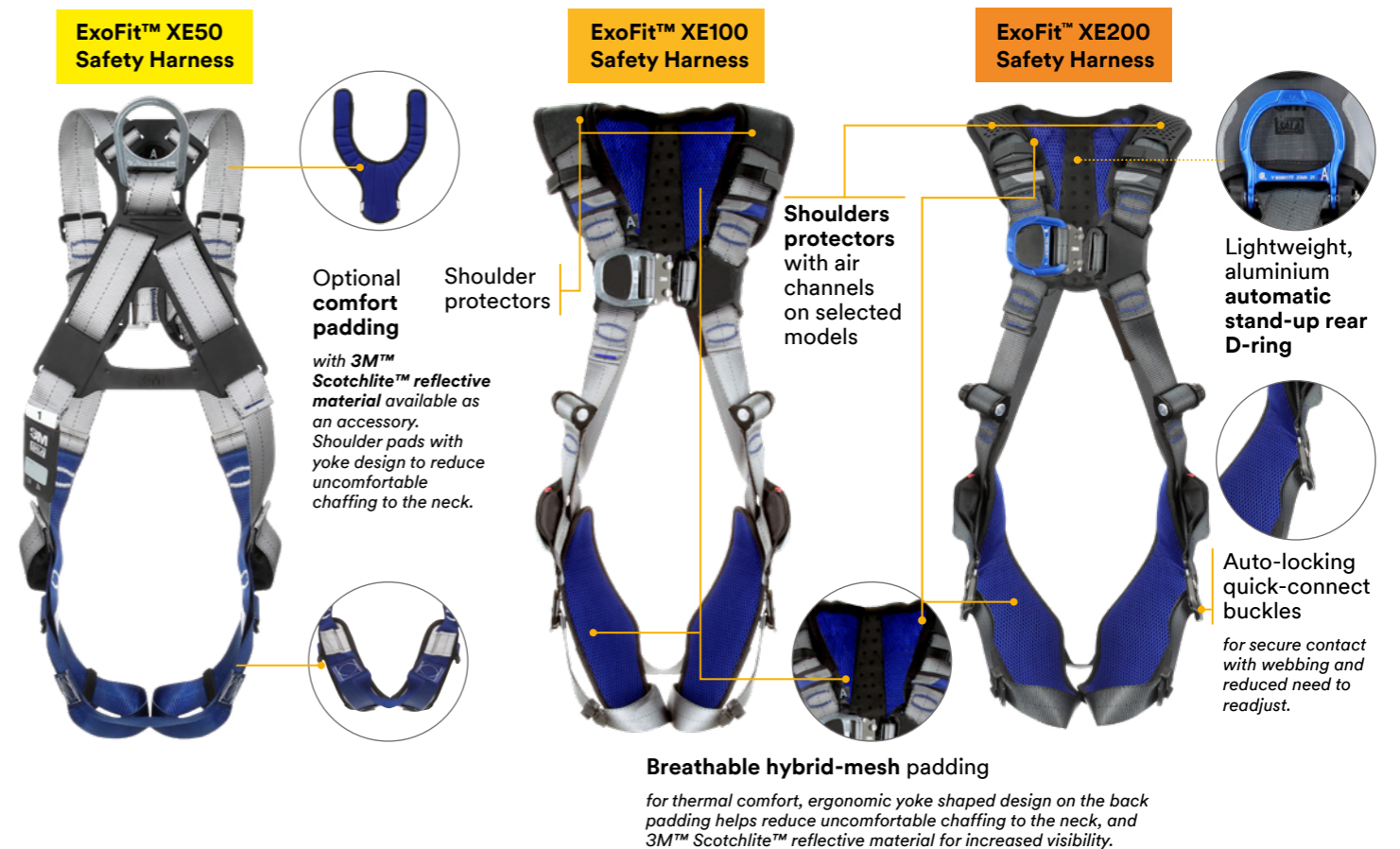

All models are available with and without belt.

All 3M™ DBI-SALA® ExoFit™ XE50, XE100 and XE200 harnesses come equipped with standard DBI-SALA® features:

- Front cross chest buckle with centred D-ring.
- Patented revolving torso adjuster: for quick, safe and comfortable fit.
- Integrated personal Self-Retracting Lifeline (pSRL) tunnel: quick and easy way to connect and disconnect personal SRLs.
- Built-in low-profile suspension trauma relief straps.
- 3M™ Connected Safety RFID tag for simplified inventory, inspection and record management.
- Re-settable & re-positionable lanyard keepers: fast and easy parking of snap hooks and carabiners.
- EN & UKCA Certified

### 3M™ DBI-SALA® ExoFit™ XE50 Safety Harness

## Designed with high-quality components

Specially developed for enhanced safety and fit whilst working at heights.

Built with durable 26kN polyester webbing and alloy steel hardware, 3M™ DBI-SALA® ExoFit™ XE50 Safety Harness was created to endure the daily conditions of your work site. The back D-ring plate design with Personal Self-retracting Lifeline (pSRL) tunnel allows quick and easy connection of personal SRLs. Revolving torso-adjustment buckles and quick-connect\* buckles will help get your team a quick, safe and comfortable harness fit. This harness is compatible with optional accessories for back/shoulder padding, leg padding and with a variety of 3M Fall Protection for Tools accessories. All models are equipped with low-profile suspension trauma relief straps.

\*Selected XE50 models are available with quick-connect pass through buckles.

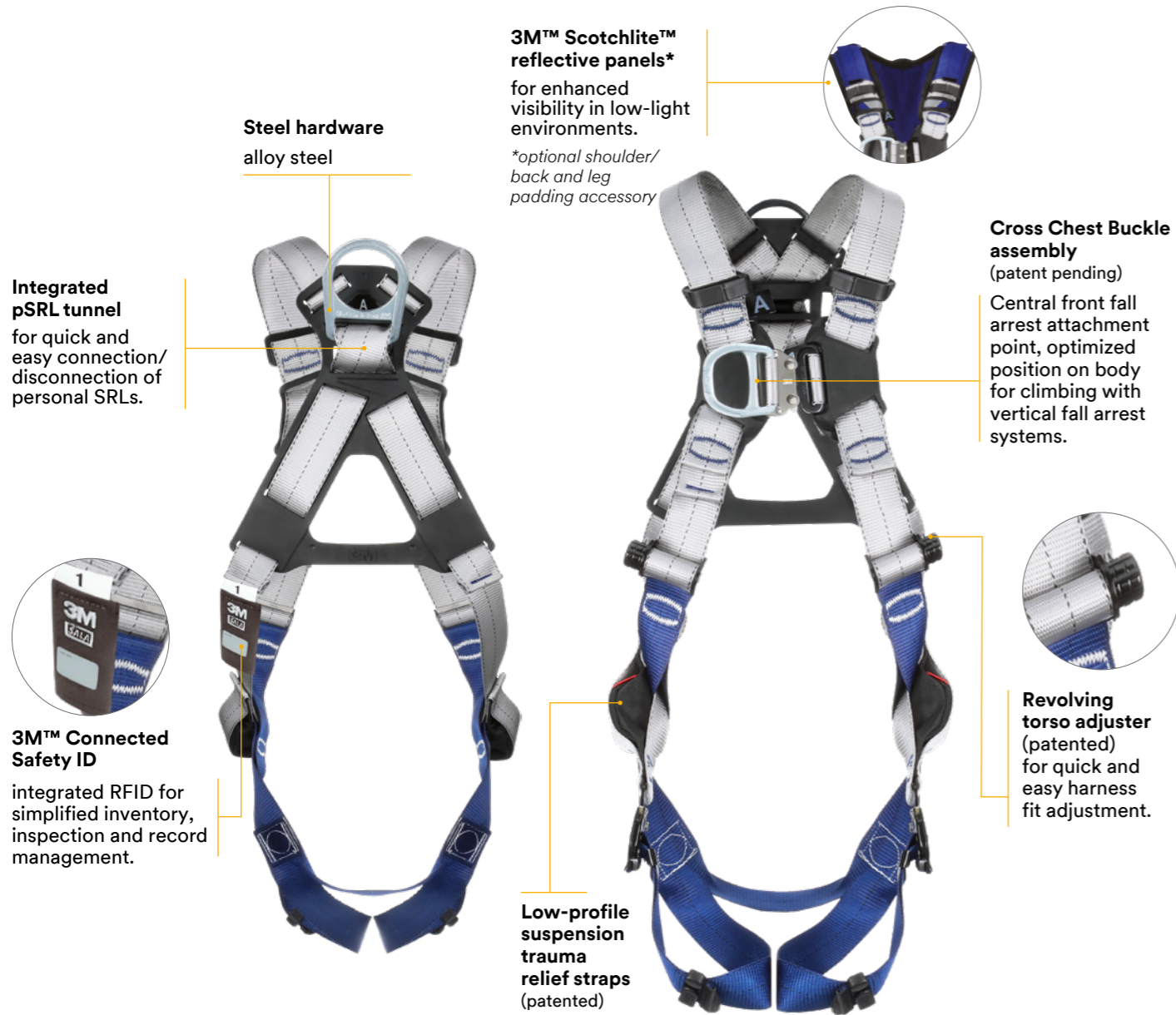

Belted models also available.

### 3M™ DBI-SALA® ExoFit™ XE100 Safety Harness

## Designed with high-quality components

Created for enhanced harness safety, fit and the comfort of your team whilst working at heights.

Built with durable 26kN polyester webbing and alloy steel hardware, the 3M™ DBI-SALA® ExoFit™ XE100 Safety Harness features nylon/polyester hybrid comfort padding with added air channels for comfort alongside reflective 3M™ Scotchlite™ panels. The back D-ring plate design with pSRL tunnel allows quick and easy connection of Personal Self-Retracting Lifelines (pSRLs). XE100 harness features revolving torso-adjustment and quick-connect buckles for a quick, safe and comfortable harness fit. This harness is compatible with variety of 3M Fall Protection for Tools accessories. All models are equipped with low-profile suspension trauma relief straps.

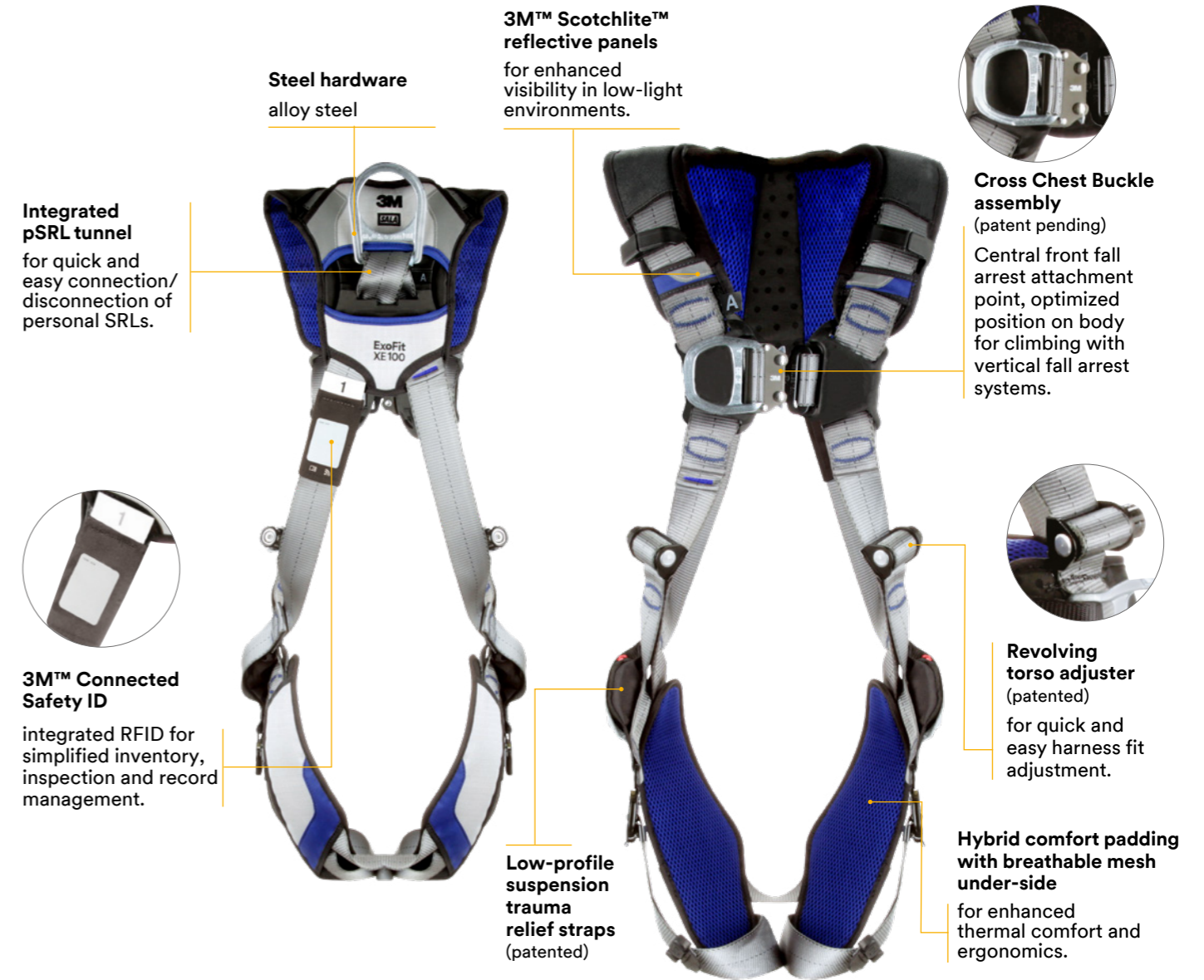

### 3M™ DBI-SALA® ExoFit™ XE200 Safety Harness

## For those who refuse to compromise.

The XE200 comfort harness is built with durable 26kN polyester webbing, lightweight aluminium hardware, hybrid comfort padding with breathable mesh under-side, and reflective 3M™ Scotchlite™ panels. Equipped with modern technology in the dorsal D-ring area for efficient connections and a secure harness fit for your workers, the XE200 also features revolving torso adjustment alongside auto-locking quick-connect buckles to optimize the fit. The 3M™ DBI-SALA® ExoFit™ XE200 Safety Harness is compatible with a range of 3M fall protection accessories for tools. All models are equipped with low-profile suspension trauma relief straps.

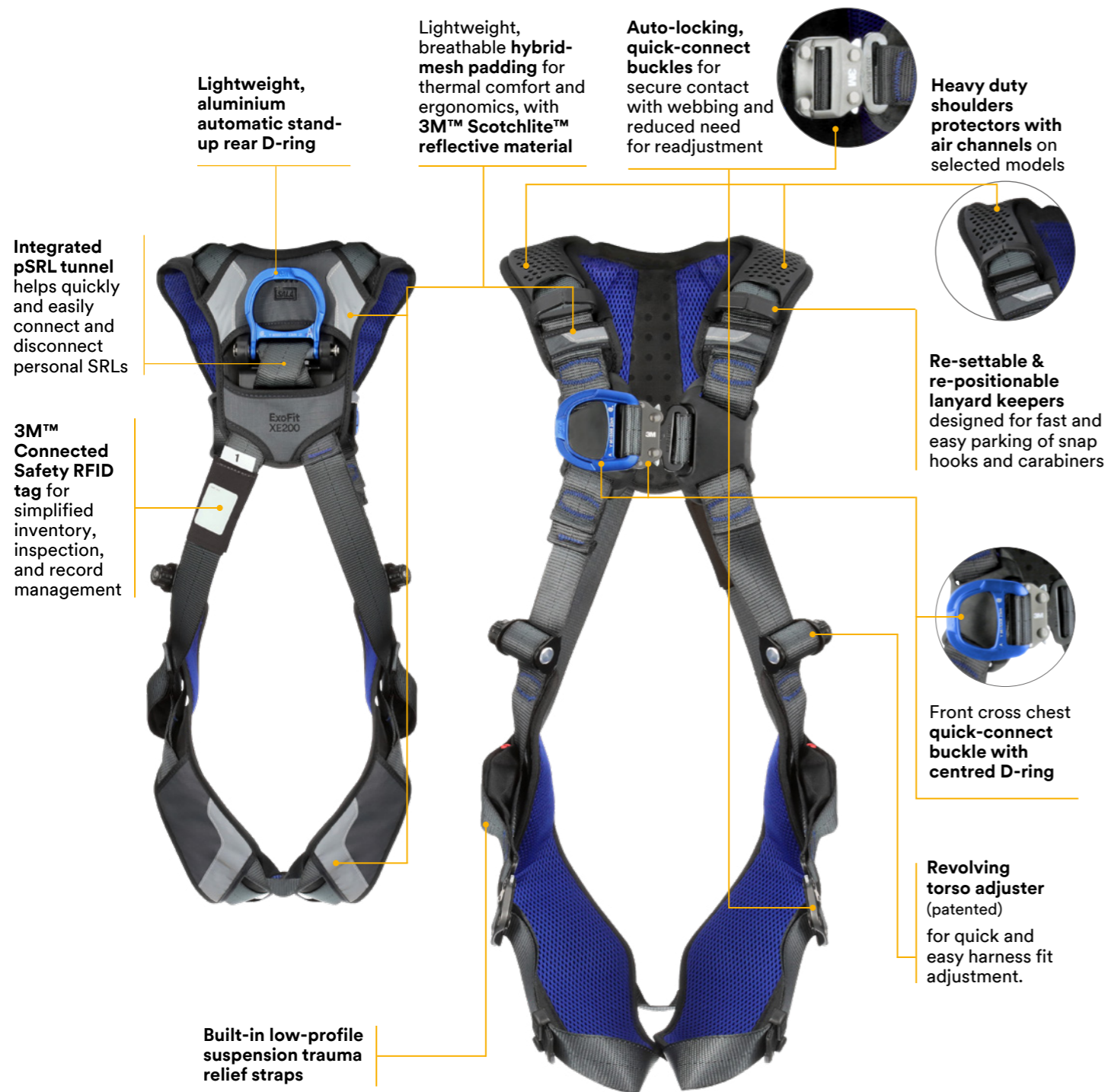

Belted models also available.

### 3M™ DBI-SALA® ExoFit™ Safety Harnesses Feature Matrix



Feature	XE50	XE100	XE200
Front Cross Chest Buckle with Centred D-ring	✓	✓	✓
Integrated pSRL Tunnel	✓	✓	✓
Revolving Torso Adjusters	✓	✓	✓
Comfort Padding (Back, Shoulders & Legs)	Optional (available as an accessory)	Custom-designed padding with air channels and reflective 3M™ Scotchlite™ panels (back/shoulders)	Lightweight, breathable padding with air channels and reflective 3M™ Scotchlite™ panels (back/shoulders & legs)
Suspension Trauma Relief Straps	✓	✓	✓
Rear D-Ring	Steel D-ring	Steel D-ring	Aluminium Automatic stand-up D-ring
Re-Settable & Re-Positionable Lanyard Keepers	✓	✓	✓
RFID	✓	✓	✓
Buckles	Pass through or Quick Connect	Quick Connect	Auto-locking Quick Connect (on belt and legs)
Available with Work Positioning Belt	✓	✓	✓
Available with Rescue Loops	✓	✓	✓
Packaging	Re-sealable plastic bag	Re-sealable plastic bag	3M™ DBI-SALA® Transport & Storage Bag

#### ExoFit™ Safety Harnesses available in a variety of styles:

- ▶ General Industry
- ▶ Retrieval – Climbing
- ▶ Climbing – Wind Energy
- ▶ Climbing – Construction – Positioning
- ▶ Retrieval – Climbing – Positioning
- ▶ Climbing – Positioning – Wind Energy

**3M™ DBI-SALA® ExoFit™ XE50 Safety Harness**



- ▶ Pass-through buckles
- ▶ Steel front centred and rear fall arrest D-rings
- ▶ Optional comfort padding

UK  
CA  
CE  
EN361

	←.....→	kg
1112702	1	1.65
1112703	2	1.70
1112704	3	1.75

**3M™ DBI-SALA® ExoFit™ XE50 Positioning Safety Harness**



- ▶ Pass-through buckles
- ▶ Steel front centred and rear fall arrest D-rings
- ▶ Steel work positioning D-rings
- ▶ Optional comfort padding

UK  
CA  
CE  
EN361  
CE  
EN358

	←.....→	kg
1112705	1	2.20
1112706	2	2.25
1112707	3	2.40

**3M™ DBI-SALA® ExoFit™ XE50 Positioning Safety Harness**



- ▶ Quick-connect buckles
- ▶ Steel front centred and rear fall arrest D-rings
- ▶ Steel work positioning D-rings
- ▶ Optional comfort padding

UK  
CA  
CE  
EN361  
CE  
EN358

	←.....→	kg
1112714	1	2.46
1112715	2	2.53
1112716	3	2.60

**3M™ DBI-SALA® ExoFit™ XE50 Rescue Safety Harness**



- ▶ Quick-connect buckles
- ▶ Steel front centred and rear fall arrest D-rings
- ▶ Optional comfort padding
- ▶ Textile rescue loops

UK  
CA  
CE  
EN361  
CE  
EN1497

	←.....→	kg
1112717	1	1.70
1112718	2	1.75
1112719	3	1.80

**3M™ DBI-SALA® ExoFit™ XE50 Rescue Safety Harness**



- ▶ Pass-through buckles
- ▶ Steel front centred and rear fall arrest D-rings
- ▶ Optional comfort padding
- ▶ Textile rescue loops

UK  
CA  
CE  
EN361  
CE  
EN1497

	←.....→	kg
1112708	1	1.70
1112709	2	1.75
1112710	3	1.80

**3M™ DBI-SALA® ExoFit™ XE50 Safety Harness**



- ▶ Quick-connect buckles
- ▶ Steel front centred and rear fall arrest D-rings
- ▶ Optional comfort padding

UK  
CA  
CE  
EN361

	←.....→	kg
1112711	1	1.65
1112712	2	1.70
1112713	3	1.75

**3M™ DBI-SALA® ExoFit™ XE100 Comfort Safety Harness**



- ▶ Quick connect buckles
- ▶ Steel front centred and rear fall arrest D-rings
- ▶ Shoulders and back comfort padding with 3M™ Scotchlite™ reflective material
- ▶ Leg comfort padding

UK  
CA  
CE  
EN361

	←.....→	kg
1112720	1	1.90
1112721	2	1.95
1112722	3	2.00

**3M™ DBI-SALA® ExoFit™ XE100 Comfort Positioning Safety Harness**



- ▶ Quick connect buckles
- ▶ Steel front centred and rear fall arrest D-rings
- ▶ Steel work-positioning D-rings
- ▶ Shoulders and back comfort padding with 3M™ Scotchlite™ reflective material
- ▶ Leg comfort padding

UK  
CA  
CE  
EN361  
CE  
EN358

	←.....→	kg
1112723	1	2.65
1112724	2	2.70
1112725	3	2.75

## 3M™ DBI-SALA® ExoFit™ XE200 Comfort Safety Harness



- ▶ Quick connect buckle - chest
- ▶ Auto-locking quick connect buckles - legs
- ▶ Aluminium automatic stand-up rear fall arrest D-ring
- ▶ Shoulders and back comfort padding with 3M™ Scotchlite™ reflective material
- ▶ Leg comfort padding with 3M™ Scotchlite™ reflective material
- ▶ Heavy-duty wear protection on shoulders



	←.....→	kg
1112726	1	2.23
1112727	2	2.25
1112728	3	2.30

## 3M™ DBI-SALA® ExoFit™ XE200 Comfort Positioning Safety Harness



- ▶ Quick connect buckle - chest
- ▶ Auto-locking quick connect buckles - legs and waist
- ▶ Aluminium front centred fall arrest D-ring
- ▶ Aluminium automatic stand-up rear fall arrest D-ring
- ▶ Aluminium work positioning D-rings
- ▶ Shoulders and back comfort padding with 3M™ Scotchlite™ reflective material
- ▶ Leg comfort padding with 3M™ Scotchlite™ reflective material
- ▶ Heavy-duty wear protection on shoulders



	←.....→	kg
1112729	1	2.85
1112730	2	2.90
1112731	3	2.95

## 3M™ DBI-SALA® ExoFit™ XE200 Comfort Positioning Safety Harness



- ▶ Quick-connect buckles - chest
- ▶ Auto-locking quick connect buckles - legs and waist
- ▶ Aluminium front centred fall arrest D-ring
- ▶ Aluminium automatic stand-up rear fall arrest D-ring
- ▶ Aluminium work positioning D-rings
- ▶ Aluminium front belt D-ring
- ▶ Shoulders and back comfort padding with 3M™ Scotchlite™ reflective material
- ▶ Leg comfort padding with 3M™ Scotchlite™ reflective material
- ▶ Heavy-duty wear protection on shoulders



	←.....→	kg
1112738	1	2.90
1112739	2	2.96
1112740	3	3.00

## 3M™ DBI-SALA® ExoFit™ XE200 Comfort Wind Energy Safety Harness



- ▶ Quick-connect buckles - chest
- ▶ Auto-locking quick connect buckles - legs
- ▶ Aluminium front centred fall arrest D-ring
- ▶ Aluminium automatic stand-up rear fall arrest D-ring
- ▶ Aluminium hip D-rings
- ▶ Shoulders and back comfort padding with 3M™ Scotchlite™ reflective material
- ▶ Leg comfort padding with 3M™ Scotchlite™ reflective material



	←.....→	kg
1112741	1	2.30
1112742	2	2.35
1112743	3	2.40

## 3M™ DBI-SALA® ExoFit™ XE200 Comfort Rescue Safety Harness



- ▶ Quick connect buckle - chest
- ▶ Auto-locking quick connect buckles - legs
- ▶ Aluminium front centred fall arrest D-ring
- ▶ Aluminium automatic stand-up rear fall arrest D-ring
- ▶ Shoulders and back comfort padding with 3M™ Scotchlite™ reflective material
- ▶ Leg comfort padding with 3M™ Scotchlite™ reflective material
- ▶ Textile rescue loops



	←.....→	kg
1112732	1	2.30
1112733	2	2.35
1112734	3	2.40

## 3M™ DBI-SALA® ExoFit™ XE200 Positioning/Rescue Safety Harness



- ▶ Quick connect buckle - chest
- ▶ Auto-locking quick connect buckles - legs and waist
- ▶ Aluminium front centred fall arrest D-ring
- ▶ Aluminium automatic stand-up rear fall arrest D-ring
- ▶ Aluminium work positioning D-rings
- ▶ Shoulders and back comfort padding with 3M™ Scotchlite™ reflective material
- ▶ Leg comfort padding with 3M™ Scotchlite™ reflective material
- ▶ Textile rescue loops



	←.....→	kg
1112735	1	2.90
1112736	2	2.95
1112737	3	3.00

## 3M™ DBI-SALA® ExoFit™ XE200 Comfort Wind Energy Positioning Safety Harness



- ▶ Quick-connect buckles - chest
- ▶ Auto-locking quick connect buckles - legs and waist
- ▶ Aluminium front centred fall arrest D-ring
- ▶ Aluminium automatic stand-up rear fall arrest D-ring
- ▶ Aluminium work positioning D-rings
- ▶ Aluminium front belt D-ring
- ▶ Shoulders and back comfort padding with 3M™ Scotchlite™ reflective material
- ▶ Leg comfort padding with 3M™ Scotchlite™ reflective material



	←.....→	kg
1112744	1	2.90
1112745	2	2.95
1112746	3	3.00

## 3M™ DBI-SALA® ExoFit™ XE200 Comfort Wind Energy Positioning Safety Harness



- ▶ Quick connect buckle - chest
- ▶ Auto-locking quick connect buckles - legs and waist
- ▶ Aluminium front centred fall arrest D-ring
- ▶ Aluminium automatic stand-up rear fall arrest D-ring
- ▶ Aluminium work positioning D-rings
- ▶ Aluminium front belt D-ring
- ▶ Shoulders and back comfort padding with 3M™ Scotchlite™ reflective material
- ▶ Leg comfort padding with 3M™ Scotchlite™ reflective material



	←.....→	kg
1112747	1	2.95
1112748	2	3.00
1112749	3	3.05

3M™ DBI-SALA® Comfort Accessory Padding For XE50 Safety Harness



Shoulder/Back Padding	Icon	kg
1150514	1 pack	0.15
Leg Padding	Icon	kg
1150513	2 pack	0.10

Comfortable, lightweight and compact padding provides the opportunity to add extra comfort to your 3M™ DBI-SALA® ExoFit™ XE50 Safety harness. Convenient features including a hook-and-loop attachment and non-slip design makes the padding easy to use, fit, and remove by the user. Heavy-duty construction is suitable for tough work environments.

3M™ DBI-SALA® Equipment Carrying and Storage Bag



9515749	Icon	kg
	1	0.40v

DBI-SALA® branded 20 L equipment carrying and storage bag to store and transport your fall arrest equipment. Compact and lightweight design combined with a heavy-duty closure system makes it a must-have accessory at your worksite. Supplied as standard with all XE200 harnesses.

3M™ DBI-SALA® ExoFit NEX™ Oil & Gas Harness



	Icon	Icon	Icon	kg
1114016	M	PT	PT	4.00
1114017	L	PT	PT	4.10
1114018	XL	PT	PT	4.20

3M™ DBI-SALA® ExoFit NEX™ Wind Energy Harness



	Icon	Icon	Icon	kg
1113210	S	CC	CC	1.86
1113211	M	CC	CC	1.91
1113212	L	CC	CC	1.95

3M™ DBI-SALA® Spreader Bar Lanyard



KF71201466	Icon	Icon	Icon	kg
	45 mm	19 mm	S	1.30

Confined space lanyard for use with rescue harness incorporating shoulder D-rings. Use for vertical lifts in confined space or rescue situations. Built in spreader bar keeps shoulder straps from being pulled in during use.



3M™ DBI-SALA® ExoFit NEX™ Suspension Harness



	Icon	Icon	kg
1113960	S	CC	2.20
1113961	M	CC	2.30
1113962	L	CC	2.40
1113963	XL	CC	2.50

3M™ DBI-SALA® ExoFit NEX™ Wind Energy Harness with Belt



	Icon	Icon	Icon	kg
1113215	S	CC	CC	3.00
1113216	M	CC	CC	3.05
1113217	L	CC	CC	3.10



# 3M™ DBI-SALA® Delta™ Harness with Nomex®/Kevlar® Webbing

Applications



The 3M™ DBI-SALA® Delta™ Harness with Nomex®/Kevlar® Webbing Harness has a 425° char temperature resistance. This innovative webbing is as flexible and soft to the touch as any traditional webbing. The harness also incorporates the 3M™ DBI-SALA® Delta™ triangular frame that allows the harness to easily fall into place when donned and increases comfort during use. Also incorporates covered labels.



For 3M™ Hot Work Lanyards see page 52



3M™ DBI-SALA® Delta™ Harness with Nomex®/Kevlar® Webbing



Best Seller 1101714

CE EN361

	↔	⊖	⊖	kg
1101714	U	PT	PT	1.71
1101718	XL	PT	PT	1.91

3M™ DBI-SALA® Suspension Trauma Safety Straps - Fire Resistant



	kg
9505712	0.14

Suspension trauma safety straps, one pair, fire resistant, attaches to most harnesses.

For 3M™ DBI-SALA® Nano-Lok™ Hot Work SRL's see page 73





# 3M™ Protecta® Fall Arrest Harnesses

The new generation of 3M™ Protecta® Fall Arrest Harnesses.

3M Protecta Fall Arrest Harnesses provide reliable protection, comfort and convenience; now with upgraded features and a sleek, modern look - all at an affordable price.

Available in a variety of styles and configurations, these new harnesses have enhanced features including, auto-resetting lanyard keepers as well as softer and more durable hip padding.

The new 3M Protecta Fall Arrest Harness range - raising the bar not the price.

### Applications



## 3M™ Protecta® Standard Vest Style Fall Arrest Harnesses

### Conveniently placed front fall arrest D-ring

Helps you stay balanced and centred\*

### Easy and clear identification of fall arrest anchorage points

### Modern black components

Zinc plated steel with electro deposit paint finish

### Auto-resetting lanyard keeper

Provides easy parking and release of snap hooks or carabiners\*\*



### Hook and loop web ends

No loose web ends help you stay comfortable and tangle-free



### Dorsal D-Ring

Fall arrest attachment point located on the back between the shoulders

### Impact indicators

Make it simple to inspect the harness for damage and help ensure it's safe to use\*\*

### Protected labels

For long-term identification and inspection

\* Applicable models with front fall arrest D-ring only  
 \*\*Excludes model 1161600, 1161601 & 1161602

3M™ Protecta® Standard Vest Style  
Fall Arrest Harness



CE  
EN361

	↔	🔗	🌀	📊
1161600	S	PT	PT	0.83
1161601	M/L	PT	PT	0.88
1161602	XL	PT	PT	0.93

3M™ Protecta® Standard Vest Style  
Fall Arrest Harness



CE  
EN361

	↔	🔗	🌀	📊
1161603	S	PT	PT	1.01
1161604	M/L	PT	PT	1.06
1161605	XL	PT	PT	1.11

3M™ Protecta® Standard Vest Style  
Fall Arrest Rescue Harness



CE  
EN361  
EN  
1497

	↔	🔗	🌀	📊
1161612	S	PT	PT	1.24
1161613	M/L	PT	PT	1.29
1161614	XL	PT	PT	1.34

3M™ Protecta® Standard Vest Style  
Fall Arrest Harness



CE  
EN361

	↔	🔗	🌀	📊
1161615	S	CC	CC	1.37
1161616	M/L	CC	CC	1.42
1161617	XL	CC	CC	1.47

3M™ Protecta® Standard Vest Style  
Fall Arrest Harness



CE  
EN361

	↔	🔗	🌀	📊
1161609	S	PT	PT	1.11
1161610	M/L	PT	PT	1.16
1161611	XL	PT	PT	1.21

3M™ Protecta® Standard Vest Style  
Fall Arrest Harness with Hi-Visibility Vest



CE  
EN361  
CE  
EN471

	↔	🔗	🌀	📊
1161606	S	PT	PT	1.55
1161607	M/L	PT	PT	1.60
1161608	XL	PT	PT	1.65



## 3M™ Protecta® Comfort Belt Style Harness



**Softer and more robust hip pad**  
3x thicker\* for extra comfort



**Durable and sturdy belt**  
For tool bag carrying convenience



\* Compared to previous model

## 3M™ Protecta® Comfort Belt Style Fall Arrest Harness



CE  
EN361  
CE  
EN358

	↔	🔗	🔗	🔗	📊
1161624	S	PT	PT	PT	1.77
1161625	M/L	PT	PT	PT	1.82
1161626	XL	PT	PT	PT	1.87

## 3M™ Protecta® Comfort Belt Style Fall Arrest Harness



CE  
EN361  
CE  
EN358

	↔	🔗	🔗	🔗	📊
1161627	S	PT	PT	PT	1.85
1161628	M/L	PT	PT	PT	1.90
1161629	XL	PT	PT	PT	1.95



## 3M™ Protecta® Comfort Belt Style Fall Arrest Harness



CE  
EN361  
CE  
EN358

	↔	🔗	🔗	🔗	📊
1161630	S	PT	PT	PT	1.91
1161631	M/L	PT	PT	PT	1.96
1161632	XL	PT	PT	PT	2.01

## 3M™ Protecta® Comfort Belt Style Fall Arrest Harness



CE  
EN361  
CE  
EN358

	↔	🔗	🔗	🔗	📊
1161633	S	QC	QC	QC	2.19
1161634	M/L	QC	QC	QC	2.24
1161635	XL	QC	QC	QC	2.29

**3M™ Protecta® Standard Vest Style Harness with Horizontal Legs**

**Articulated rings on horizontal leg straps**

Allow upper and lower body to twist providing greater freedom of movement



**3M™ Protecta® Comfort Belt Style Harness with Horizontal Legs**

**Rotating belt**

Enables movement within the harness while working in restraint/positioning

**Articulated rings on horizontal leg straps**

Allow upper and lower body to twist providing greater freedom of movement

**Gear tool loops\***

Tools can be secured while working at heights, to keep people and property safe anywhere below you

\* Gear tool loops offered as standard on models 1161645, 1161646 & 1161647. Gear tool loops (accessory 1150492) can be retro-fitted on all other belted models. Comfort Leg Padding as standard on models 1111645\_46\_47. For other models the accessory 1150494 is available and can be retro-fitted



**3M™ Protecta® Comfort Belt Style Fall Arrest Harness with Horizontal Leg Straps**



CE EN361  
CE EN358

	↔	⊗	⊙	⊖	kg
1161645	S	⊗	⊙	⊖	2.41
1161646	M/L	⊗	⊙	⊖	2.46
1161647	XL	⊗	⊙	⊖	2.51

**3M™ Protecta® Standard Vest Style Fall Arrest Harness with Horizontal Leg Straps**



CE EN361

	↔	⊗	⊙	kg
1161639	S	⊗	⊙	1.27
1161640	M/L	⊗	⊙	1.32
1161641	XL	⊗	⊙	1.37

**3M™ Protecta® Standard Vest Style Fall Arrest Harness with Horizontal Leg Straps**



CE EN361

	↔	⊗	⊙	kg
1161642	S	⊗	⊙	1.57
1161643	M/L	⊗	⊙	1.62
1161644	XL	⊗	⊙	1.67

**3M™ Protecta® Comfort Belt Style Fall Arrest Suspension Harness**



CE EN361  
CE EN358  
CE EN813

	↔	⊗	⊙	kg
1161764	S	⊗	⊙	2.49
1161765	M/L	⊗	⊙	2.65
1161766	XL	⊗	⊙	2.75



**3M™ Protecta® Nylon Transport Bag**



	←-----→	kg
<b>AK043</b>	500 × 300 mm	0.32

Nylon transport bag.

**3M™ Protecta® Back Pack**



		kg
<b>9513331</b>		0.43

3M Protecta branded rucksack to store and transport your fall arrest equipment.

**3M™ Protecta® Duffle Bag**



	←-----→	kg
<b>AK066</b>	35 × 20 × 20 cm	0.52

Duffle bag for transport.

**3M™ Protecta® Harness Comfort Shoulder and Back Padding**



		kg
<b>1150491</b>		0.15

Comfortable, lightweight and breathable padding for better comfort and shoulder and back protection. Can be easily fitted or removed by the user. Suitable for all new 3M Protecta harness models.

**3M™ Protecta® Harness Lanyard Keepers**



		kg
<b>1150493</b>		0.20 (pair)

Auto-resetting lanyard keeper provides easy parking and release of snap hooks or carabiners. 2 pack.

**3M™ Protecta® Tripod Transport Bag**



		kg
<b>AK0100</b>		1.16

Transport bag for AM100 Tripod.

**3M™ Protecta® Harness Comfort Leg Padding**



		kg
<b>1150494</b>		0.35 (pair)

Removable leg pads for additional comfort. Suitable for all new 3M Protecta harness models. 2 pack.

**3M™ Protecta® Back D-Ring Extension Strap**



		kg
<b>1150909</b>		0.22

Back D-ring extension strap 45 mm webbing. Screw gate triangle to attach to harness.

CE  
EN354

**3M™ Protecta® Belt Loop D-Ring Tool Attachments**



		kg
<b>1500180</b>		0.50 (pair)

Tools can be secured while working at heights, to keep people and property safe anywhere below you – suitable for use with 3M Protecta Comfort Belt Harness models only.

**3M™ Protecta® Harness Gear Tool Loops**



		kg
<b>1150492</b>		0.36 (pair)

Tools can be secured while working at heights, to keep people and property safe anywhere below you – suitable for use with 3M Protecta Comfort Belt Harness models only. 2 pack.

**3M™ Protecta® Welders Harnesses**

Our welders harness is specifically designed to resist potential heat damage experienced in welding applications.

Highly durable, heat resistant and flame retardant webbing combined with a lightweight design provides the ideal body support solution for welding at height.

**Specifications**

- Webbing: Modacrylic over Kevlar®, 45 mm
- Stitching: High strength Kevlar® thread
- Breaking Strength: > 2600daN
- Buckles: High strength zinc-plated steel pass through
- D rings: Zinc plated wrought steel
- CE EN361

**Applications**



**3M™ Protecta® Welders Harness with Quick Connect Buckles**



	↔	Ⓞ	Ⓞ	kg
1161231	S	Ⓞ	Ⓞ	1.35
1161232	M/L	Ⓞ	Ⓞ	1.42
1161233	XL	Ⓞ	Ⓞ	1.50

**3M™ Protecta® Welders Harness**



	↔	Ⓞ	Ⓞ	kg
AB11312K	S	Ⓞ	Ⓞ	1.25
AB11313K	M/L	Ⓞ	Ⓞ	1.30
AB11314K	XL	Ⓞ	Ⓞ	1.40

**5 Points of Adjustment**

- Ideally adapts to your body.
- Greater comfort and enhanced safety.

**Torso Adjusters**

- Simple pull down adjustment.
- Spare webbing stored in hip strap.

**Modacrylic Kevlar® webbing**

- Heat resistant and flame retardant.
- 370°C char temperature.

**Pass Through Steel Buckles**

- Simple, safe and fast connection.



**Large Rear D Ring**

- Easier to connect
- Reduced risk of roll out.

**Fall Indicators**

- Easy inspection, enhanced safety.

**Label Pouch**

- Protects identification labels.

**Weight Capacity**

- 140 kg.

**3M™ Protecta® Welders Harness**



	↔	Ⓞ	Ⓞ	kg
AB10213K	M/L	Ⓞ	Ⓞ	1.30
AB10214K	XL	Ⓞ	Ⓞ	1.40

**3M™ DBI-SALA® Suspension Trauma Safety Straps - Fire Resistant**



	kg
9505712	0.14

Fire resistant suspension relief safety straps for full body harness.



# Choosing the right lanyard.

Lanyards are split into 3 distinct types, each with a specific purpose: shock absorbing lanyards (with absorber), restraint lanyards (no absorber), and work positioning lanyards.

## Shock Absorbing Lanyards

These lanyards are for use in situations where a user is exposed to a potential risk of fall. Whether they are made of rope or of webbing, whether they are adjustable or not, shock absorbing lanyards incorporate a shock absorbing system to ensure forces are limited in a fall to under 6 kN.



## Restraint Lanyards

A connecting lanyard must only be used for restraining purposes. In no case should the user be able to manoeuvre in an area where there is a risk of falling. The restraint system is precisely defined for each place where it will be used.



## Work Positioning Lanyards

A work positioning lanyard when used in conjunction with a belt/harness with a belt allows the user to work in comfort, whilst keeping both hands free. Normally a work position system would be used in conjunction with a fall arrest system.



# Lanyard icons.

General:			Type:			
Dimension	Weight	Certification	Material Type	Material: Aluminium	Material: Steel	
Lanyards:						
Lanyard	Tie-Back	Loops with Thimbles	Carabiner	Screw Carabiner	Gate Strength (Value)	Breaking Strength (Value)
Size of gate opening	Twist Lock	Connector: Lanyard End	Connector: User End	Rope Type	Scaffold Hook	Snap Hook

3M™ DBI-SALA® EZ-Stop™ Shock Absorbing Lanyard

**Shock Pack**  
Rated to 130 kg max. user weight.

**3M™ DBI-SALA® Energy Absorbing Technology**  
Extremely compact and durable.

**Identification Labels**  
Easy to access, fully protected.

**Nylon Reflector Strips**  
Better visibility in low light conditions.

**Body Connector**  
Aluminium Twist Lock or Triple Lock options for greater security.

**Applications**



3M™ DBI-SALA® EZ-Stop™ Shock Absorbing Webbing Lanyard

	↔	🧠	🔗	🔗	🔗	🏋️
1246540	2 m	2	🔗	60 mm	0.98	CE EN355

- General purpose fall arrest lanyards with polyester webbing leg material.

<b>Leg Material</b>	Web
<b>Body Connector</b>	Aluminium Twist Lock, 20 mm opening, 28 kN breaking strength
<b>Anchor Connectors</b>	AJ527/0, Aluminium, 60 mm opening, 22 kN breaking strength or Aluminium Twist Lock, 20 mm opening, 28 kN breaking strength



3M™ DBI-SALA® EZ-Stop™ Shock Absorbing Edge Tested Lanyard

DBI-SALA® EZ-Stop Edge Tested range of lanyards are designed to offer greater security to users exposed to falls over or around edges and tested rigorously over a 0.5 mm radius edge. All edge tested products in the DBI-SALA range are differentiated from DBI-SALA standard shock absorbing lanyards and bear the Edge Tested logo.

- The fall arrest solution for all users working at height exposed to falls around or over edges.
- 12 mm diameter rope offers extreme durability whilst maintaining flexible handling for ease of use. Orange accenting indicates suitability for edge applications.

<b>Leg material</b>	12 mm diameter kernmantle rope
<b>Body Connector</b>	AJ512/0, Aluminium Triple Lock, 22 mm opening size, 25 kN breaking strength or AJ567/0, Aluminium, 21 mm opening size, 22 kN breaking strength
<b>Anchor Connectors</b>	AJ527/0, Aluminium, 60 mm opening, 22 kN breaking strength or AJ512/0, Aluminium Triple Lock, 22 mm opening size, 25 kN breaking strength
<b>Maximum User Weight</b>	100 kg Edge Tested / 130 kg Non Edge Applications



	↔	🧠	🔗	🔗	🔗	🔗	🏋️
Best Seller 1246547	1.5 m	2	🔗	21 mm	🔗	60 mm	1.65
1246548	2 m	1	🔗	21 mm	🔗	60 mm	1.11

3M™ DBI-SALA® EZ-Stop™ Shock Absorbing Rope Lanyard

	↔	🧠	🔗	🔗	🏋️
1246559	1.25 m	1	🔗	20 mm	0.63
1246544	2.00 m	1	🔗	20 mm	0.65

- 10.5 mm diameter braided rope with sewn terminations and thimbles to protect high abrasion areas from wear.
- Not designed for use in edge applications - please see our edge tested shock absorbing lanyards.

<b>Leg Material</b>	10.5 mm kernmantle rope
<b>Body Connector</b>	Aluminium Twist Lock, 20 mm opening, 28 kN breaking strength
<b>Anchor Connectors</b>	AJ527/0, Aluminium, 60 mm opening, 22 kN breaking strength or Aluminium Twist Lock, 20 mm opening, 28 kN breaking strength



3M™ DBI-SALA® EZ-Stop™ Shock Absorbing Expander Lanyard



Best Seller  
1246557

	↔	👤	🔗	🔗	🏋️
1246555	1.25 m	1	🔗	60 mm	0.97
1246556	2 m	1	🔗	60 mm	1.06
1246557	2 m	2	🔗	60 mm	1.64

CE EN355

- Elasticated webbing reduces length by up to 50 cm when not under tension.
- Reduced trip or snarling hazard.
- Leg material - 35 mm polyester webbing.

3M™ DBI-SALA® Expander Shock Absorbing Lanyard



	↔	👤	🔗	🔗	🔗	🔗	🏋️
KE5200YX/2	2 m	2	🔗	11 mm	🔗	60 mm	1.61

CE EN355

The Expander elastic system reduces this lanyards overall length whilst not under tension by up to 0.5 m thus reducing potential trip or snarling hazards and offering maximum freedom of movement during use. Semi permanent triangular screw link for attaching to harness.

<b>Leg Material</b>	35 mm polyester webbing
<b>Body Connector</b>	AJ508 Triangular screw link, 10 mm opening, 27 kN breaking strength
<b>Anchor Connectors</b>	KJ527 Aluminium Scaffold Hook, 60 mm opening, 25 kN breaking strength

3M™ DBI-SALA® EZ-Stop™ Pear Hook Tie-Back Shock Absorbing Lanyard



	↔	👤	🏋️
1224569	1.65 m	2	1.70

CE EN355

The EZ-Stop Pear Hook Tie-Back Lanyard features the innovative design and performance of our premium EZ-Stop lanyard range but allows users to operate safely with an even wider array of anchor points. The Pear Hook can connect around materials up to 50 mm diameter but also be used through small diameter (~22 mm) anchor points that would not work with standard scaffold hooks. The tie-back ring can also be used to form an anchor point by tying back the lanyard around suitable part of the structure being climbed.

- Aluminium pear hook nose profile allows small diameter anchor points to be used.
- Suitable for connecting directly to an anchor up to 50 mm in diameter.
- Tie-back rings allow the lanyard to create an anchor from an existing structure.
- Wear sleeve protects leg material from premature wear.
- Leg material - 12 mm polyamide rope.

<b>Body Connector</b>	Aluminium, Triple Lock, 20 mm opening, 28 kN breaking strength
<b>Anchor Connectors</b>	Aluminium, Double Action, 50 mm opening, 23 kN breaking strength
<b>Maximum User Weight</b>	130 kg (100 kg in applications where user is exposed to a fall over a 0.5 mm radius edge)

Tie-back ring can be used to create an anchor point from an existing structure.



Pear hook nose profile allows the hook to be used in small diameter anchor points.



3M™ DBI-SALA® Work Positioning Rope Trigger Lanyard



Best Seller 1200313

	↔	∅	🔗	🔗	🔗	🔗	🔗	🔗	🔗	kg
1200313	Adj to 2 m	11 mm	🔗	21 mm	(A)	🔗	21 mm	(A)	0.74	
1200324	Adj to 2.5 m	11 mm	🔗	21 mm	(A)	🔗	21 mm	(A)	0.80	
1200311	Adj to 5 m	11 mm	🔗	21 mm	(A)	🔗	21 mm	(A)	0.92	
1200316	Adj to 10 m	11 mm	🔗	21 mm	(A)	🔗	21 mm	(A)	1.43	

CE EN358

Braided rope, diameter 11 mm. All models have a blue protective cover on the rope.

Twist Lock Self-Locking Carabiner



Best Seller AJ514

	🔗	🔗	🔗	kg
AJ514	18 mm	(S)	25 kN	0.18
KJ5024	21 mm	(A)	25 kN	0.48
AJ593	50 mm	(S)	25 kN	0.71
2000112	17 mm	(S)	22 kN	0.23
2000113	30 mm	(S)	22 kN	0.41
2000127	18 mm	(SS)	22 kN	0.32

CE EN362

The automatic gate closing and locking makes it an ideal choice when the user will open and close the connector many times during the work period. Quick and easy to open with one hand.

Screw Gate Carabiners

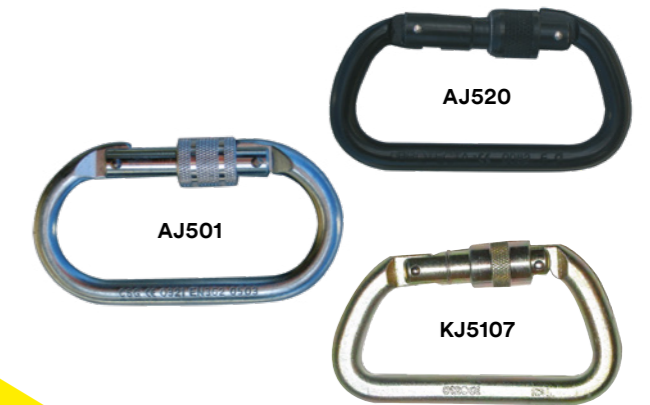

Best Seller AJ501

	🔗	🔗	🔗	kg
AJ520	17 mm	(A)	25 kN	0.09
AJ501	17 mm	(S)	25 kN	0.17
KJ5107	25 mm	(S)	50 kN	0.22

CE EN362

The screw gate is ideal in working situations where opening is occasional during the working day, as the gate can be opened by the action of pushing it onto the anchorage point. The gate can then be manually locked once the carabiner holds the weight of the device.



For Fall Protection for Tools see pages 118-121



Triple Twist Lock Self-Locking Carabiner



	🔗	🔗	🔗	kg
AJ572	24 mm	(A)	22 kN	0.11

CE EN362

Triple lock provides the user with confidence that the gate will not accidentally unlock.

Scaffold and Snap Hooks

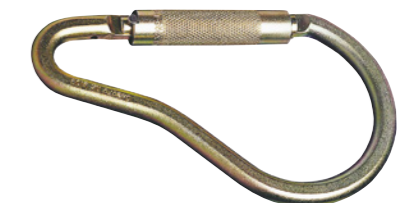

	🔗	🔗	🔗	kg
KJ5108	50 mm	(S)	30 kN	0.70

CE EN362

This detachable scaffold hook can be attached to spliced or webbing lanyards, and other PPE products. Detachable with internal gate means it can be added to a range of products and stays there until it is decided to be removed.

## 3M™ Protecta® Shock Absorbing Lanyards - 140 kg Capacity

Protecta® lanyard specifically designed for higher weight capacity of 140 kg. Strong, lightweight and available in 10.5 mm diameter rope or elastic webbing, a range of lengths, connection types and number of legs to suit your needs.

**CE certified to EN355 standard**

**Elasticated webbing\* reduces lanyard length when not under tension**

Helps reduce the risk of trip and snagging hazards.

**140 kg max. rated weight capacity**

Increased weight capacity allows for greater range of users.

**Small, compact shock absorber pack**

Less bulk for you to carry.

**Fully covered labels**

Long-term identification and inspection.

**Steel scaffold hook with self-locking gate**

50 mm opening allows you to climb structures with the security of a self-locking gate. (Other connect options available - see table below).

**Lightweight**

Helps reduce the carry weight of your equipment.

**Steel twist-lock carabiner**

Easy, secure body connection. (Other connect options available - see table below).



1260329

1260331

**10.5 mm rope**  
For easy and flexible handling.

**Steel snap hook or screw gate carabiner**  
Allows for easy and secure body connection.

### 3M™ Protecta® Shock Absorbing Rope Lanyards - 140 kg

	Length	Legs	Scaffold Hook		Snap Hook		Weight (kg)
			Icon	Weight	Icon	Weight	
1260331	2 m	1	50 mm	0.80	19 mm	0.80	0.80
1260332	1.8 m	2	50 mm	1.40	17 mm	1.40	1.40
1260333	1.8 m	2	50 mm	1.40	19 mm	1.40	1.40
1260334	1.3 - 2 m	1	17 mm	0.80	17 mm	0.80	0.80

### 3M™ Protecta® Shock Absorbing Elastic Webbing Lanyards - 140 kg

	Length	Legs	Scaffold Hook		Snap Hook		Weight (kg)
			Icon	Weight	Icon	Weight	
1260327	2 m	2	18 mm	1.40	50 mm	1.40	1.40
1260328	2 m	1	18 mm	1.10	50 mm	1.10	1.10
1260329	1.5 m	2	18 mm	1.20	50 mm	1.20	1.20
1260330	1.5 m	1	18 mm	1.00	50 mm	1.00	1.00

### 3M™ Protecta® Pro-Stretch™ Lanyard - Edge Tested



- Tested over a 0.50 mm Radius edge
- Enhanced protection for workers exposed to working over edges
- Two layers of tube webbing offer exceptional product life & durability
- Available with Twist Lock or Triple Lock carabiner body connector for even greater security
- Differentiated from standard Pro-Stretch Lanyard - by orange edging to label pouch and black striped tube webbing
- Various connectors are available depending on the needs of the user ranging from standard carabiners to large opening scaffold hooks

	Length	Scaffold Hook		Snap Hook		Weight (kg)
		Icon	Weight	Icon	Weight	
AE5220SBB/SE	2 m	17 mm	0.79	18 mm	0.79	0.79
AE5220SBK/SE	2 m	17 mm	1.08	60 mm	1.08	1.08

### 3M™ Protecta® Sanchoc™ Shock Absorbing Lanyards



- Supple & flexible webbing offers great ease of use
- Highly abrasion resistant webbing with 25 mm & 45 mm width options
- Terminations sewn with high strength polyester thread
- Identification labels protected within transparent shock pack cover
- Wide range of designs and connector options available

	Length	Scaffold Hook		Snap Hook		Weight (kg)
		Icon	Weight	Icon	Weight	
AE5315WAA	1.5 m	17 mm	0.98	17 mm	0.98	0.98
AE5315WAF	1.5 m	17 mm	1.70	50 mm	1.70	1.70
AE5320WAA	2 m	17 mm	0.98	17 mm	0.98	0.98
AE5320WAF	2 m	17 mm	1.80	50 mm	1.80	1.80

## 3M™ Protecta® Welders Lanyards

### Resistant

- Heat and char resistant shock pack cover that slips over shock pack, heat resistant up to 371°C
- Reinforced webbing with Nomex® /Kevlar® fiber to protect shock pack from getting burned

### Safe

- Weight capacity: 100 kg
- Scaffolding hook: 23 kN
- Oval carabiner: 25 kN
- Meets CE standard EN355:2002

### Ergonomic

- Different configurations, single and twin leg, that can be connected at foot level to meet your specific needs
- Lightweight design to improve comfort



### 3M™ Protecta® Welders Shock Absorbing Single Leg Lanyard with Scaffold Hook

	↔	🔗	🔗	🔗	🔗	🔗	🔗	🔗	🔗	📊
AE5215KBF	1.5 m		🔗	17 mm	Ⓢ	🔗	50 mm	Ⓢ		1.05
AE5220KBF	2.0 m		🔗	17 mm	Ⓢ	🔗	50 mm	Ⓢ		1.15

Single leg with Kevlar® webbing, with AJ514 steel twist lock carabiner 17 mm opening and AJ595 steel scaffold hook 50 mm opening



### 3M™ Protecta® Welders Shock Absorbing Twin Leg Lanyard with Scaffold Hook

	↔	🔗	🔗	🔗	🔗	🔗	🔗	🔗	🔗	📊
AE5315KBF	1.5 m	■	🔗	17 mm	Ⓢ	🔗	50 mm	Ⓢ		1.05
AE5320KBF	2.0 m	■	🔗	17 mm	Ⓢ	🔗	50 mm	Ⓢ		1.85

Twin leg with Kevlar® webbing, with AJ514 steel twist lock carabiner 17 mm opening and 2 AJ595 steel scaffold hooks 50 mm opening.



### 3M™ Protecta® Sanchoc™ Kernmantle Rope Edge - Tested Lanyard



- Tested over a 0.50 mm Radius edge
- Enhanced protection for workers exposed to working over edges
- 12.50 mm Kernmantle rope offers exceptional durability and product life
- Available with Twist Lock carabiner body connector for even greater security
- Differentiated from standard Sanchoc kernmantle rope lanyards by Orange colour yarn

	↔	🔗	🔗	🔗	🔗	🔗	🔗	🔗	🔗	📊
AE5315REK/SE	1.5 m	■	2	🔗	19 mm	Ⓢ	🔗	60 mm	Ⓐ	1.80

### 3M™ Protecta® Restraint Lanyard

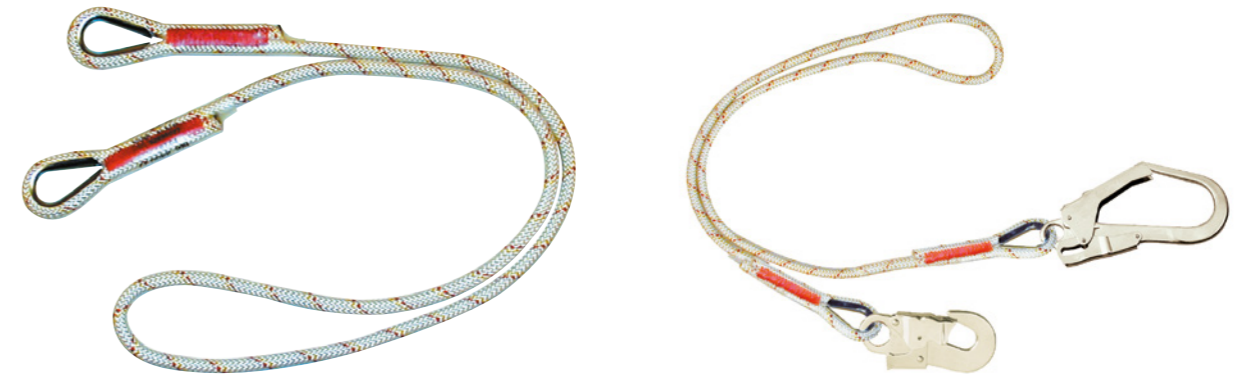

	↔	🔗	🔗	🔗	🔗	🔗	🔗	🔗	🔗	📊
AL410B	1 m	1	-	-	-	-	-	-	-	0.11
AL410C	1 m	1								0.16
AL410C2	2 m	1	🔗	17 mm	Ⓢ	🔗	50 mm	Ⓢ		0.91
AL415C	1.5 m	1								0.19
AL420B	2 m	1	-	-	-	-	-	-	-	0.18
AL420C	2 m	1								0.22
AL420C2	2 m	1	🔗	17 mm	Ⓢ	🔗	50 mm	Ⓢ		0.91
AL4000	1.8 m	1								0.23

Protecta rope connecting lanyards are an ideal solution for the connecting element in a restraint system. Made from polyamide braided rope with safety stitching. Rope diameter 10.50 mm.

3M™ Protecta® Work Positioning Lanyard - Trigger



The Protecta adjustment system has been improved to give the option to easily adjust the length of the lanyard during use.

These versions have a triple action carabiner AJ572 with a zinc plated steel snaphook (ref: AJ523) and are available in different lengths.

Max weight capacity: 140 kg.

	↔	∅	⚙️			⚙️			⚖️
1200314	Adj to 2 m	10.5 mm	⚙️	21 mm	Ⓢ	⚙️	24 mm	Ⓐ	0.85
1200317	Adj to 3 m	10.5 mm	⚙️	21 mm	Ⓢ	⚙️	24 mm	Ⓐ	0.92
1200315	Adj to 4 m	10.5 mm	⚙️	21 mm	Ⓢ	⚙️	24 mm	Ⓐ	0.99

CE EN358

3M™ Protecta® Rope Work Positioning Lanyard - Adjustable



Braided rope work positioning lanyards available in a variety of diameters and connector combinations.

	↔	∅	⚙️			⚙️			⚖️
AL422	Adj. 2 m	10.5 mm	-	-	-	-	-	-	0.28
AL422/3	Adj. 2 m	10.5 mm	⚙️	17 mm	Ⓢ	⚙️	50 mm	Ⓐ	1.00
AL423/5	Adj. 2 m	12.5 mm	⚙️	17 mm	Ⓢ	⚙️	17 mm	Ⓢ	0.80

CE EN358

Applications



3M™ Protecta® Cobra™ Vertical Lifeline Rope Grab

- The Cobra rope grab device is available in 3 variants and a variety of different lengths to suit a wide variety of applications.
- The Cobra locks automatically when it is closed to ensure safe use.
- Its articulated cam, guarantees optimum slide of the rope and locks immediately in the event of a fall.
- A lever allows you to position the Cobra on the rope by hand, which makes it a fantastic tool for positioning or restraint.

CE EN353-2

	⚙️	Description	∅	⚖️
AC202/01	AJ501	with carabiner	12-14 mm	1.03
AC202/02	AJ565	with extension strap and shock pack	12-14 mm	1.15
AC202/03	AJ565	with extension strap	12-14 mm	1.11

The Cobra rope grab device is supplied with a twisted strand rope and is available with rope options available in 5 to 50 m lengths in increments of 5 m. The Rope Grab Device is available in 3 variants. AC202/3 includes a 200 mm extension strap and AC202/2 also incorporates a shock absorber with a 25 mm tear pack with an engaging force of 2 kN which reduces the impact force to less than 6 kN.

Cobra Vertical Lifeline Rope



14 mm Twisted 3 strand rope to be used with Cobra device with AJ501 carabiner fixed to one end.

	↔	⚙️	⚖️
AC205	5 m	⚙️	0.91
AC210	10 m	⚙️	1.53
AC215	15 m	⚙️	2.17
AC220	20 m	⚙️	2.60
AC225	25 m	⚙️	3.41
AC230	30 m	⚙️	3.50

CE EN353-2

### Applications



### 3M™ Protecta® Viper™ Vertical Lifeline Rope Grab

- It's extremely simple opening system means that the Viper 2 can be attached to the rope or removed from it at any location.
- As soon as the connecting carabiner is put back into place the Viper 2 is locked to ensure safe use.

		$\varnothing$	
AC400	AJ501	10.5 mm	0.44

The Viper 2 is supplied with a kernmantle rope and is available with rope options from 5 to 99 m lengths in increments of 5 m.

CE  
EN353-2



### Viper LT Rope Grab with Extension



AC4001	0.56

Vertical fall arrest 140 kg user. Roof top work restraint use. A 175 mm extension strap with self-locking double action snap hook to aid ease of use when rope grab is attached to the harness.

CE  
EN353-2

### Viper Vertical Lifeline Rope



	$\longleftrightarrow$	
AC405	5 m	0.58
AC410	10 m	0.91
AC415	15 m	1.24
AC420	20 m	1.59
AC430	30 m	2.26

Polyamide kernmantle static rope,  $\varnothing$  10.50 mm, with yellow and red wear indicator. Rope end: sewn loop underneath protective sleeve Connector: AJ501, 17 mm opening System breaking strength > 22 kN.

CE  
EN353  
EN353-2

### Viper LT Rope Grab with Energy Absorber - Edge Tested



AC4002	0.48

Vertical fall arrest 140 kg user. Energy absorber for fall arrest over sharp edge applications. Edge Tested Model.

CE  
EN353-2

### Viper LT Rope



	$\longleftrightarrow$	
AC4010	10 m	1.00
AC4015	15 m	1.24

Kernmantle rope 12.55 mm dia. 25 kN screw gate carabiner, 17 mm opening.

CE  
EN353-2



# Choosing the right Self-Retracting Lifeline (SRL).

DBI-SALA® and Protecta® are fall protection brands developing innovative, reliable and versatile SRL's.

Our innovations include retractable lifelines, sealed SRLs, dual mode rescue SRLs, and 3-way SRL with built in retrieval and fall impact indicator. These important safety innovations have now been widely adopted and embraced by customers across all sectors of industry.

Whether your application requires single or twin-leg configurations, mounting to an overhead anchor or for connection directly to a harness, there are numerous models to choose from to suit almost any application.

Considerations when choosing your SRL:

### Housing Construction

Thermoplastic - When lightweight is key.  
Aluminium - When ultimate durability is required.

### Lifeline Material

Galvanised cable, stainless steel cable or web / synthetic lifeline material for varying environments.

### Sealed Design

For harsh/corrosive environments like Oil & Gas applications.

### Retrieval

Ideal for confined space rescue / retrieval applications for easy implementation of rescue plan solutions.

### RSQ™ Dual Mode Design

Built-in rescue allows user to be lowered after a fall arrest either automatically or manually.

### 3M™ DBI-SALA® FAST-Line™ Cable

Allows user to replace lifeline assembly in the field (available for 3M™ DBI-SALA® Sealed-Blok™ SRL only).

### Harness Mount

Direct connection takes the hassle out of fall protection.

### Sharp Edge Compliant

Specialised lifeline and external shock for leading edge, horizontal use, meeting the latest VG11 sharp edge requirements.

## Self-Retracting Lifelines icons.



Housing



Double Action Swivel



Retrieval Winch



RSQ



Load Rating/ Capacity



Leading Edge



Self Locking Swivel Hook



Lifeline Material



Fall Indicator



Connector Material



Carabiner



Captive Eye



Rebar Hook



Scaffold Hook



Snap Hook



Swivelling Opening Hook



Webbing Width



Twin Leg



# 3M™ DBI-SALA® Sealed-Blok™ Self-Retracting Lifelines

## Trusted

3M™ DBI-SALA® continues to set the standard for quality in fall protection. The Sealed-Blok SRL family has a fully comprehensive line of sealed SRLs and decades of proven field service.

## Durable

- Stands up to the harshest environments
- Heavy-duty design
  - Corrosion resistant
  - Stainless steel end-plates
  - Aluminium housing

## Reliable

- Dynamic components sealed inside the housing (IP69K rated)
  - Protects from particles entering product
  - Protected against complete or continuous submersion in water
- Decades of service
- Field proven in the world's toughest environments
- Design extends maintenance intervals and product longevity

## Typical Applications

Oil rig drilling  
 Confined space  
 Saltwater environments  
 Dirty environments  
 Sewage plants

## Typical Markets

Oil and gas  
 Off-shore wind energy  
 Mining  
 Marina  
 Utilities  
 Waste water treatment  
 Municipalities

## Applications



### Anti-Ratcheting Design

Stays locked on rigid and non-rigid (horizontal lifeline) anchors.

### Sealed Design

(Patent Pending)  
 Ensures efficient, safe operation under all working conditions - meets IP69K sealed rating.

### 141 kg Weight Capacity

Higher capacity for operator and tools.

### Carrying Handle

Built-in design for easy transport with improved ergonomics.

### Secondary Anchorage Point

Certified for "dropped objects" Protection Rated for fall arrest if primary anchor fails.

### Retrieval Winch

### 3M™ DBI-SALA® Sealed-Blok™ Self Retracting Lifeline - RSQ™ Dual Mode Design

Allows user to select between fall arrest mode and descent mode.

### 5 mm Diameter Wire Rope

Stainless steel for corrosion resistance.

### Self-Locking Swivel Hook

Limits lifeline twisting.

### IP69K Rated

### Pivoting Anchorage Loop

Centres the load.

### Aluminium Housing

Provides exceptional strength, durability and corrosion resistance.

### Stainless Steel End-Plate

Durable construction for harsh environments.

### Tripod/Davit Arm Bracket

No tools required for install.

### Ergonomic Cable Handle

Provides added comfort and ease-of-use when making connections.

### Galvanised and Stainless Steel Cable

Abrasion resistant and corrosion resistant lifeline options.

### 3M™ DBI-SALA® FAST-Line™

Provides the user with ability to replace the lifeline in the field. Eliminates the need to service / reset the brake after a fall arrest.

### Impact Indicator

Provides visual indication of Fall Arrest.

### 16 kN Gate

Reduces chances of accidental disengagement ("roll-out").

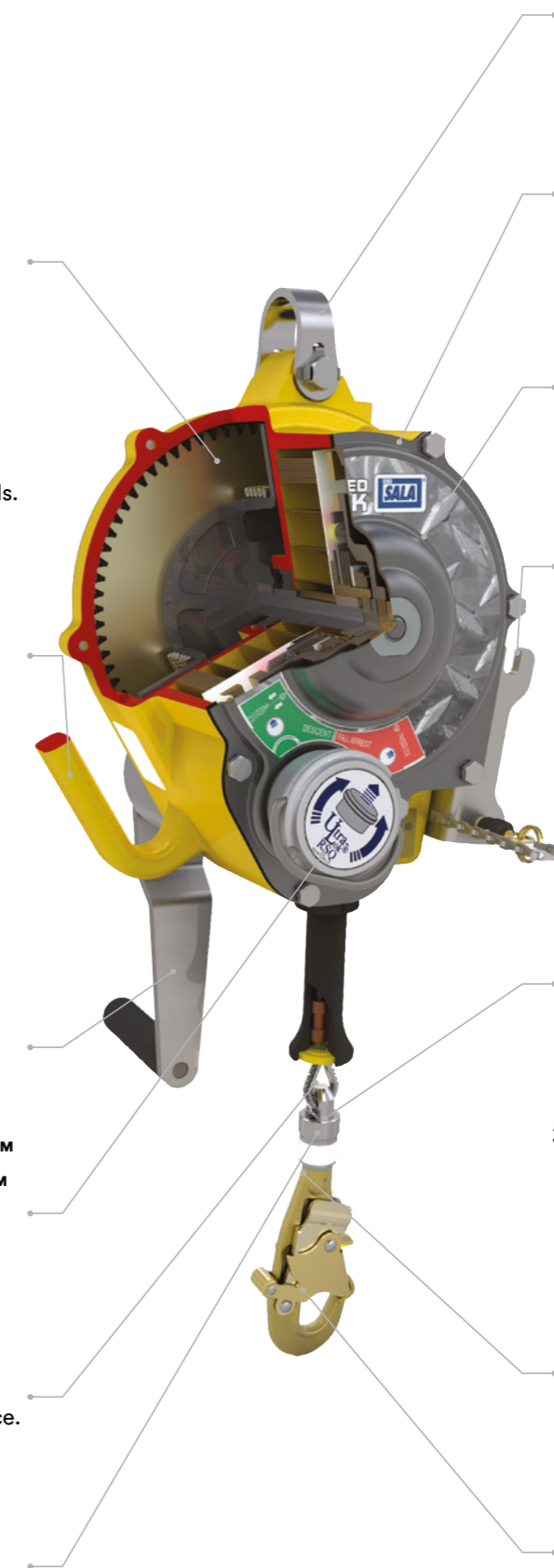

3M™ DBI-SALA® Sealed-Blok™ Cable Self-Retracting Lifeline - 4.5 m - 9 m



Best Seller  
3400805

CE EN360  
EN 1496  
(Retrieval models)

	←→	⚙	⚙	⚙	⚙	kg
3400830	4.5 m	SS	SS			6.00
3400805	9 m	SS	SS			9.00
3400856	9 m	SS	SS	■		12.00

3M™ DBI-SALA® Sealed-Blok Cable SRL - 15 m



Best Seller  
3400956

CE EN360  
EN 341 CLASS D  
(RSQ™ models)  
EN 1496  
(Retrieval models)

	←→	⚙	⚙	⚙	⚙	kg
3400950	15 m	G	G			13.00
3400951	15 m	SS	G			13.00
3400961	15 m	SS	SS		■	13.00
3400956	15 m	SS	SS	■		14.90
3400944	15 m	SS	SS	■	■	14.90

3M™ DBI-SALA® Sealed-Blok™ Cable Self-Retracting Lifeline - 53 m



3400656

CE EN360

	←→	⚙	⚙	kg
3400656	53 m	G	G	56.50
3400658	53 m	SS	SS	56.50

3M™ DBI-SALA® Sealed-Blok Cable SRL - 25 m



3400867

3400881

Best Seller  
3400881

CE EN360  
EN 341 CLASS D  
(RSQ™ models)  
EN 1496  
(Retrieval models)

	←→	⚙	⚙	⚙	⚙	kg
3400867	25 m	SS	SS			22.00
3400881	25 m	SS	SS	■		23.50
3400917	25 m	SS	SS	■	■	23.50

3M™ DBI-SALA® Sealed-Blok Cable SRL - 40 m



3400986

3400971

Best Seller  
3400986

CE EN360  
EN 1496  
(Retrieval models)

	←→	⚙	⚙	⚙	⚙	kg
3400971	40 m	G	G			26.00
3400972	40 m	SS	SS			26.00
3400986	40 m	SS	SS	■		30.00

3M™ DBI-SALA® First-Man-Up™ Assisted Rescue Tool



3500202

kg  
3.00

First-Man-Up 4.8 m pole with rescue tool for Sealed-Blok RSQ™ SRL.

3M™ DBI-SALA® First-Man-Up™ Assisted Rescue Tool Fork

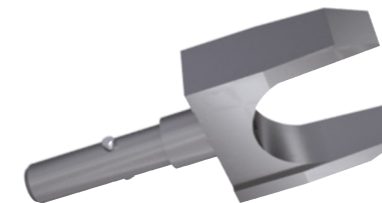

3500200

kg  
0.50

Rescue fork tool for Sealed-Blok RSQ SRL.



# 3M™ DBI-SALA® Ultra-Lok™ Self-Retracting Lifelines

Ultra-Lok web and cable SRLs are rugged, highly engineered devices that can be counted on for user safety, efficiency and reliability. Available with synthetic rope, stainless steel or galvanised steel cable and aluminium or thermoplastic housing. The Ultra-Lok RSQ™ model is an innovative dual-mode SRL for fall arrest and integrated rescue.

## Applications



## 3M™ DBI-SALA® Ultra-Lok™ RSQ™ Dual Mode Design

Our RSQ feature allows the user, prior to connection, to choose their mode of operation. This two-in-one operation lowers the cost of ownership by reducing the need for separate rescue equipment and ensuring you always have a rescue plan.

- Standard fall arrest mode
- Automatic descent mode - self rescue
- Remote / Assisted descent activation options



Fall Arrest - Assisted Rescue by Hand

Fall Arrest - Assisted Rescue by Pole

Automatic Descent Mode



### Anchor Swivel

Allows the block to align with lifeline and avoid any torsion of the cable when the user is working.

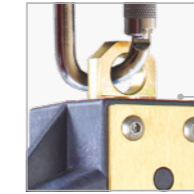

### Lightweight and Durable Thermoplastic Housing

Provides exceptional durability and is lightweight for easy handling.



### Stainless Steel Components

Stainless steel internal parts ensures increased corrosion resistance and operational longevity.



### Semi-sealed Design

Gasket between the housings makes the block semi-sealed which increases protection against the intrusion of dust and water thereby offering additional protection against corrosion.



### Constant Moving Pawls, Anti-ratchet System

Anti-ratchet system means the pawls do not easily disengage after a fall. This innovative feature ensures that the pawls will remain engaged even if the anchorage structure is flexible and likely to induce rebounds.



### Reserve Lifeline

Allows the brake to perform even if a fall occurs when the cable is fully extended.



### Impact Indicating Hook

Allows easy visual inspection to determine if the unit has experienced a fall by a user.

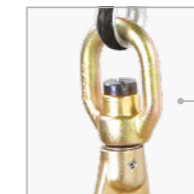

### 141 kg Weight Capacity

Higher capacity for operator and tools.

### Web SRL

Nylon web lifeline models are lighter weight for added comfort and are less abrasive to objects around the system.

### Sharp Edge SRL Models Available

Innovative design incorporates larger diameter 5.5 mm cable and an in-line shock absorber for the demands of leading edge applications.

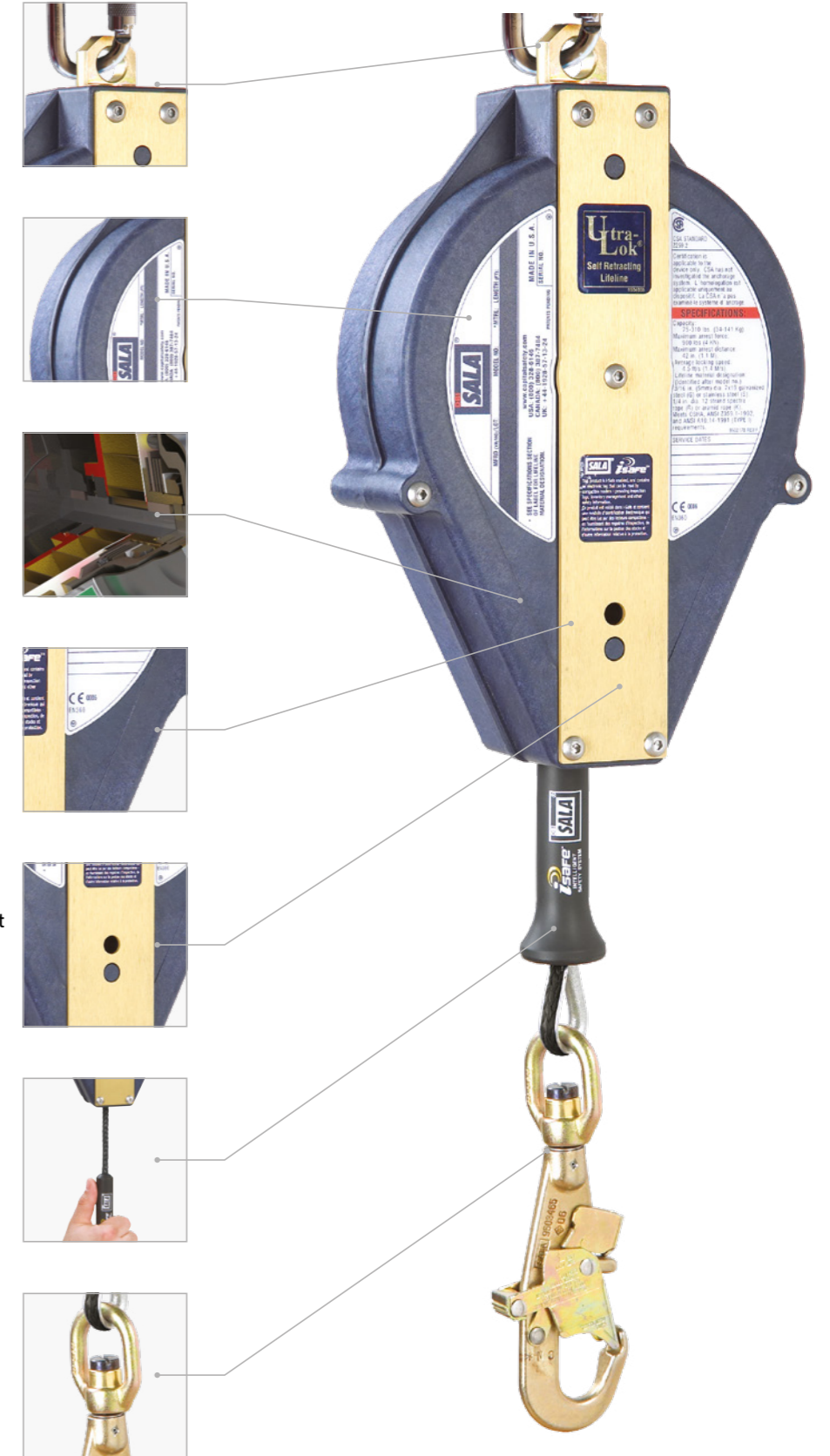

3M™ DBI-SALA® Ultra-Lok™ Cable SRL - 6 m



Best Seller  
3504427

CE  
EN360

	↔	🔗	🔒	⤴	🏋️
3504427	6 m	Ⓜ	Ⓢ	18 mm	4.50
3504429	6 m	ⓈⓈ	ⓈⓈ	18 mm	4.50

3M™ DBI-SALA® Ultra-Lok™ Cable SRL - 9 m



Best Seller  
3504424

CE  
EN360

	↔	🔗	🔒	⤴	🏋️
3504424	9 m	Ⓜ	Ⓢ	18 mm	5.40
3504426	9 m	ⓈⓈ	ⓈⓈ	18 mm	5.40

3M™ DBI-SALA® Ultra-Lok Cable RSQ™ SRL - 15 m



Best Seller  
3504553

RSQ  
CE  
EN360  
EN  
341  
CLASS D

	↔	🔗	🔒	⤴	🏋️
3504553	15 m	Ⓜ	Ⓢ	18 mm	8.50
3504555	15 m	ⓈⓈ	ⓈⓈ	18 mm	8.50

3M™ DBI-SALA® Ultra-Lok™ Cable SRL - 15 m



CE  
EN360

	↔	🔗	🔒	⤴	🏋️
3504465	15 m	Ⓜ	Ⓢ	18 mm	7.45
3504467	15 m	ⓈⓈ	ⓈⓈ	18 mm	7.45

3M™ DBI-SALA® Ultra-Lok™ Cable SRL - 25 m



CE  
EN360

	↔	🧑	🔗	🔒	⤴	🏋️
3504489	25 m	Ⓐ	Ⓜ	Ⓢ	18 mm	15.00

3M™ DBI-SALA® First-Man-Up™ Assisted Rescue Tool



3500102

🏋️

2.00

First Man Up™ 4.8 m pole with rescue tool for Ultra-Lok RSQ SRL.

3M™ DBI-SALA® First-Man-Up™ Assisted Rescue Fork



3500100

🏋️

0.30

Rescue fork tool for Ultra-Lok RSQ SRL.

# 3M™ DBI-SALA® Nano-Lok™ Web Self-Retracting Lifelines

## Maintain safe fall distances for improved worker safety

### Compact

Nano-Lok is ergonomically designed for ease-of-use and is ideal for direct connection to most harnesses. And at only 970 g, it's virtually unnoticeable on your back, stays out of the way and can be easily used as a lanyard upgrade.

### Versatile

Whether your application requires single or twin leg configurations, mounting to an overhead anchor or for connection directly to a harness, there are more than 10 models to choose from to suit almost any application.

### Safe

Nano-Lok locks quickly - stopping a fall within centimetres - providing more protection at low heights. In addition, tension is always kept on the lifeline, which reduces dragging, snagging and trip falls. Both features are key safety improvements versus use of a lanyard.

### Steel Fast Connection System



### Applications



### Compatible with a Shoulder or Foot Connection

Improve safety by allowing a shoulder and foot level connection for 141 kg capacity.

### Extremely Compact and Lightweight

At just 970 g this SRL is extremely lightweight and along with its compact size, it is virtually unnoticeable on your back.

### 140 kg Weight Capacity

- Higher capacity for operator & tools.
- Fall Factor 2 compliant: can be connected at foot level.

### Wide Variety of Configurations

Provides complete jobsite versatility and flexibility.



### Steel Fast Connection System

- Attaches directly to back of most harnesses - no separate carabiner required.
- Installs to web, leaving dorsal D-ring open for other equipment or rescue.
- Design provides snug fit to worker's back eliminates nuisance "flopping".
  - Components the same for both single and twin-leg versions.

### Swivelling Anchorage Loop

Limits lifeline twisting for smoother operation.

### Impact-Resistant Housing

High-strength housing provides maximum durability.

### Automatic Quick-Activating Arrestor

- Stops falling worker within inches - reduces fall distances and average arresting forces to 6 kN or less.
- Advanced webbing (thickness 1.5 mm, width 20 mm).

### Shock Absorber

- Integrated shock absorber provides visual indication of a fall.
- Nitrile rubber cover provides extended durability.

### Meets or Exceeds Industry Standards

EN360 : 2002.

3M™ DBI-SALA® Nano-Lok™ Web SRL



Best Seller  
3101208

CE  
EN360

	←.....→	ⓐ	ⓐ	kg
3101208	2 m	ⓐ	57 mm	1.29

3M™ DBI-SALA® Nano-Lok™ Web SRL



CE  
EN360

	←.....→	ⓐ	ⓐ	kg
3101264	1.95 m	ⓐ	19 mm	0.97

3M™ DBI-SALA® Nano-Lok™ Web SRL



CE  
EN360

	←.....→	ⓐ	ⓐ	kg
3101265	1.95 m	Ⓢ	19 mm	1.28

3M™ DBI-SALA® Nano-Lok™ Web SRL



CE  
EN360

	←.....→	ⓐ	ⓐ	kg
3101461	2 m	ⓐ	57 mm	1.42

3M™ DBI-SALA® Nano-Lok™ Web SRL



CE  
EN360

	←.....→	ⓐ	ⓐ	kg
3101263	2.0 m	ⓐ	57 mm	1.37

3M™ DBI-SALA® Nano-Lok™ Web SRL



CE  
EN360

	←.....→	ⓐ	ⓐ	kg
3101709	2.1 m	ⓐ	63.5 mm	1.59

3M™ DBI-SALA® Nano-Lok™ Web SRL



CE  
EN360

	←.....→	ⓐ	ⓐ	kg
3101207	1.95 m	ⓐ	57 mm	1.31

3M™ DBI-SALA® Nano-Lok™ Web SRL



CE  
EN360

	←.....→	ⓐ	ⓐ	kg
3101261	2.0 m	ⓐ	57 mm	1.38

3M™ DBI-SALA® Nano-Lok™ Web SRL



CE  
EN360

	←.....→	ⓐ	ⓐ	kg
3101730	2.0 m	ⓐ	63.5 mm	1.10

3M™ DBI-SALA® Nano-Lok™ Web Self-Retracting Lifeline



CE EN360

3M™ DBI-SALA® Nano-Lok™ Web Self-Retracting Lifeline



CE EN360

Best Seller  
3101298

Product Code	Length	Attachment	Width	Weight
3101316	2 m	A	57 mm	2.58
3101298	2 m	A	57 mm	2.47

3M™ DBI-SALA® Nano-Lok™ Hot Work Self-Retracting Lifeline.

**Durable**

Reinforced webbing with Nomex®/Kevlar® fibre to withstand sparks, weld spatter and other high heat exposure.

**Versatile**

A range of different Nano-Lok configurations, single and twin-leg, that can be connected at foot level to meet your specific needs.

**Safe**

Arc flashed to 8 calories (8 cal/cm²), for hot work use in applications like welding, grinding and torching. Meets or exceeds industry standards. CE EN360:2002. Weight capacity 140 kg.

**Applications**



3M™ DBI-SALA® Nano-Lok™ Web SRL



CE EN360

3M™ DBI-SALA® Nano-Lok™ Web SRL



CE EN360

3M™ DBI-SALA® Nano-Lok™ Web SRL



CE EN360

Product Code	Length	Attachment	Width	Weight
3101270	2.0 m	A	57 mm	2.62
3101718	2.0 m	A	63.5 mm	3.06
3101719	2.0 m	A	63.5 mm	2.06

3M™ DBI-SALA® Nano-Lok™ Hot Work Web SRL



Best Seller  
3101522

CE EN360

3M™ DBI-SALA® Nano-Lok™ Hot Work Web SRL



CE EN360

Product Code	Length	Attachment	Width	Weight
3101522	2 m	A	57 mm	1.50
3101525	2 m	A	57 mm	3.20
3101523	2 m	S	19 mm	1.66

## 3M™ DBI-SALA® Nano-Lok™ Edge Self-Retracting Lifeline - the zero radius edge rated SRL

Nano-Lok Edge is specifically designed for foot level tie-off and sharp edge applications often found in construction. It is ergonomically designed for ease-of-use and is ideal for direct connection to most harnesses. The extremely compact and lightweight design is virtually unnoticeable on your back, staying out of the worker's way and making it ideal as a lanyard replacement. Whether your application requires single or twin leg configurations, mounting to an overhead anchor or for connection directly to harness, there are numerous models to choose from to suit almost any application. Nano-Lok locks quickly - stopping a fall within inches - providing more protection at low heights. In addition, tension is always kept on the lifeline, which reduces dragging, snagging and trip falls. Both features are key safety improvements.

### Applications



### 3M™ DBI-SALA® Nano-Lok™ Edge Tested Cable SRL



	↔	⚙	⚙	⚙	⚙	⚖
3500243	2.5 m		⚙	ⓐ	63.5 mm	1.30
3500240	2.4 m	■	⚙	ⓐ	63.5 mm	2.81

### Dedicated Foot Level Tie-Off

Dedicated design minimises fall forces, auto retraction of unused lifeline minimises trip hazards.

### Integrated Back-Pack Style Energy Absorber

Works with connector to limit fall forces, for extreme sharp edge performance. Back pack design stays tight, evenly disperses weight.

### Designed to Meet Sharp Edge Standards

Cable - Galvanised steel 5 mm lifeline - Extreme sharp edge protection - Meets CE EN:2002 & standard requirements of VH11.60 rev 7.

Web - High-resistance web 20 mm Dyneema® web makes lightweight and extreme resistance performance possible.



### Easy-Fit Connector

360° rotation, full integration with energy absorber, frees D-Ring for other equipment.

### Impact-Resistant Housing

Lightweight but extremely durable.

### 141 kg Weight Capacity

- Ultimate jobsite flexibility to accommodate users who carry more equipment.
- Fall Factor 2 compliant; can be connected at foot level.

### Galvanised Steel 5 mm Lifeline

Extreme sharp edge protection.

### Multiple Hook Options

Configure to your unique requirements.

### 3M™ DBI-SALA® Nano-Lok™ Edge Tested Cable SRL



	↔	⚙	⚙	⚙	⚙	⚖
3500224	2.4 m		⚙	ⓐ	19 mm	1.70

### 3M™ DBI-SALA® Nano-Lok™ Edge Tested Cable SRL



Best Seller  
3500244

	↔	⚙	⚙	⚙	⚙	⚖
3500244	2.4 m		⚙	ⓐ	57 mm	1.46
3500241	2.4 m	■	⚙	ⓐ	57 mm	2.49

3M™ DBI-SALA® Nano-Lok™ Edge Tested Web SRL



	Length	Attachment	Locking	Device	Diameter	Weight
3101430	2.4 m	None	None	(A)	19 mm	1.30
3101440	2.4 m	None	None	(A)	19 mm	2.22

3M™ DBI-SALA® Nano-Lok™ Edge Tested Web SRL



	Length	Attachment	Locking	Device	Diameter	Weight
3101432	2.5 m	None	None	(A)	63.5 mm	1.70

3M™ DBI-SALA® Nano-Lok™ Edge Tested Web SRL



	Length	Attachment	Locking	Device	Diameter	Weight
3101448	2.5 m	None	None	(S)	63.5 mm	3.22

3M™ DBI-SALA® Nano-Lok™ Edge Tested Web SRL



	Length	Attachment	Locking	Device	Diameter	Weight
3101433	2.5 m	None	None	(A)	57 mm	1.30
3101443	2.5 m	None	None	(A)	57 mm	2.22

3M™ DBI-SALA® Nano-Lok™ Edge Tested Web SRL



	Length	Attachment	Locking	Device	Diameter	Weight
3101436	2.4 m	None	None	(A)	19 mm	1.46

3M™ DBI-SALA® Nano-Lok™ Edge Tested Web SRL



	Length	Attachment	Locking	Device	Diameter	Weight
3101435	2.4 m	None	None	(Z)	50 mm	1.63
3101445	2.4 m	None	None	(Z)	50 mm	2.88



**3M™ DBI-SALA® Nano-Lok™ XL Web Self-Retracting Lifeline** - providing up to 33% more lifeline to the user than standard models. The additional length increases the anchorage options for the user and further establishes Nano-Lok as a versatile personal SRL.

- Single leg and twin leg option.
- Can be connected at foot level.
- 2.8 m to 3.4 m length models available.
- A range of different models with different carabiner and snap hooks.
- Extremely compact unit.
- Industry standards. CE EN360:2002.
- Weight capacity 140 kg.

Applications



3M™ DBI-SALA® Nano-Lok™ XL Web SRL



CE EN360

	←→	⚙️	Ⓜ️	⓪	⚖️
3101614	3.4 m	Ⓜ️	Ⓜ️	19 mm	1.20

3M™ DBI-SALA® Nano-Lok™ XL Web Self-Retracting Lifeline



CE EN360

	←→	⚙️	Ⓜ️	⓪	⚖️
3101620	2.8 m	Ⓜ️	Ⓜ️	57 mm	1.50

3M™ DBI-SALA® Nano-Lok™ XL Web SRL



CE EN360

	←→	⚙️	Ⓜ️	⓪	⚖️
3101637	2.98 m	Ⓜ️	Ⓜ️	57 mm	2.90

3M™ DBI-SALA® Nano-Lok™ XL Web SRL



CE EN360

	←→	⚙️	Ⓜ️	⓪	⚖️
3101616	3.4 m	Ⓜ️	Ⓜ️	19 mm	1.50

3M™ DBI-SALA® Nano-Lok™ XL Web SRL



CE EN360

	←→	⚙️	Ⓜ️	⓪	⚖️
3101617	3.4 m	Ⓜ️	Ⓜ️	19 mm	1.20

3M™ DBI-SALA® Nano-Lok™ XL Web SRL



CE EN360

	←→	⚙️	Ⓜ️	⓪	⚖️
3101644	2.8 m	Ⓜ️	Ⓜ️	57 mm	1.50

**3M™ DBI-SALA® Nano-Lok™ XL SRL for Overhead Use.**

- Speed sensing brake activation system provides protection at low heights.
- Tension is always kept on the lifeline, which helps reduce dragging, snagging and trip falls.
- Durable nitrile energy absorber cover is a smaller design and last four times longer than previous textile cover.

CE EN360

	←→	⚙️	Ⓜ️	⓪	⚖️
3103867	6.0 m	Ⓜ️	Ⓜ️	19 mm	3.00
3103877	6.0 m	Ⓜ️	Ⓜ️	19 mm	2.75



3103867



3103867



# 3M™ Protecta® Self-Retracting Lifeline

Total compliance, absolute confidence.

3M™ Protecta® SRLs are available with a heavy duty aluminium or a durable lightweight thermoplastic housing, providing an economical fall protection solution without compromising on performance or safety. Integrated ergonomic carrying handle and top swivel connector ensure easy transport and installation. Built-in fall indicator hook allows visual yearly inspection.

## Applications



### Anchor Swivel

Allows the block to align with lifeline and avoid any torsion of the cable when the user is working.

### Choice of Housing (Thermoplastic or Aluminium)

Durable thermoplastic for lightweight or aluminium for ultimate ruggedized housing allows for job site flexibility.

### Galvanized or Stainless Steel 5 mm Cable or High-strength polyester webbing

Larger cable diameter for added strength and safety.

### Side Cable Exit

Allows best alignment of the cable and minimises cable guide wear.

### 140 kg Weight Capacity

High capacity allows for use by most users and tools ensuring the highest level of safety.

### Ergonomic Cable Bumper

Allows the block to align with lifeline and avoid any torsion of the cable when the user is working.



### Ergonomic Carrying Handle

Allows easier transportation of the block.

### Swivel Hook with Fall Indicator

Allows easy visual indication if a fall has occurred.

**3M™ Protecta® Cable Self-Retracting Lifelines - 4.5 m**



CE EN360

	←→	🔗	👤	🔑	📊
3590024	4.5 m	🔗	👤	🔑	2.80

**3M™ Protecta® Cable SRL - 6 - 15 m**



CE EN360

Best Seller  
3590521 & 3590570

	←→	🔗	👤	🔑	📊
3590520	6 m	🔗	👤	🔑	5.30
3590521	10 m	🔗	👤	🔑	5.60
3590522	10 m	🔗	👤	🔑	5.60
3590570	15 m	🔗	👤	🔑	7.50
3590571	15 m	🔗	👤	🔑	7.50

**3M™ Protecta® Cable SRL - 20 - 30 m**



CE EN360

Best Seller  
3590610

	←→	🔗	👤	🔑	📊
3590610	20 m	🔗	👤	🔑	10.00
3590611	20 m	🔗	👤	🔑	10.00
3590650	25 m	🔗	👤	🔑	13.00
3590651	25 m	🔗	👤	🔑	13.00
3590690	30 m	🔗	👤	🔑	13.40
3590691	30 m	🔗	👤	🔑	13.40

**3M™ Protecta® Cable SRL Cover**



Best Seller  
3590010

	Description	kg
3590010	For 6 m, 10 m models	0.20
3590011	For 15 m models	0.20
3590012	For 20 m, 25 m, 30 m models	0.28

**3M™ Protecta® Web Self-Retracting Lifelines**



CE EN360

	←→	🔗	👤	🔑	📊
3100420	2 m	🔗	👤	🔑	1.20
3100421	2 m	🔗	👤	🔑	1.40
3100422	2.1 m	🔗	👤	🔑	2.60

**3M™ Protecta® Cable Leading Edge SRL**



CE EN360

Best Seller  
3590545

	←→	🔗	👤	🔑	📊
3590542	6 m	🔗	👤	🔑	5.60
3590545	12 m	🔗	👤	🔑	8.50

Complies to extreme sharp edge (VG11.054, type B, 0 mm radius). Users are able to tie-off at foot level with the 6 m model. This built-in sharp edge product was put through extensive sharp edge testing to ensure protection against sharp, abrasive and leading edges found at construction sites.

**3M™ Protecta® Cable Retrieval SRL**



CE EN360

EN 1496

Best Seller  
3591002

	←→	🔗	👤	🔑	📊
3591002	15 m	🔗	👤	🔑	11.90
3591003	15 m	🔗	👤	🔑	11.90

These Retrieval models incorporate fall arrest and a built-in emergency retrieval winch for rescue, making them a versatile solution for many job sites.

- 15 m SRL with rescue winch
- Brackets available for easy tripod integration
- Designed for confined space applications

3590498 - Bracket for AM100 Protecta tripod  
3590499 - Bracket for DBI-SALA® tripods KM1PT7 and KM1PT9 and 3M™ DBI-SALA® Davit HC.

**3M™ Protecta® Web SRL - 3 m**



CE EN360

Best Seller  
3100423

	←→	🔗	👤	🔑	📊
3100423	3 m	🔗	👤	🔑	1.40

**3M™ Protecta® Web SRL - 6 m**



CE EN360

Best Seller  
3100437

	←→	🔗	👤	🔑	📊
3100437	6 m	🔗	👤	🔑	2.20



## Rescue systems.

When the clock starts ticking, you need a rescue plan you can count on to rescue you quickly and efficiently.

### Choosing rescue and descent systems

The type of job site, anchor location, working load and limit, and ease of use are some important considerations when choosing the appropriate rescue and descent system. A single rescue system cannot efficiently handle every scenario, performing well for one application but not another. Some rescue systems are easy to use for one application, while others require more skill but can be adapted for use in multiple situations.

We offer a wide variety of Rescue system solutions, including the 3M™ DBI-SALA® Sealed-Blok™ RSQ™ Dual Mode Descent SRL as well as the compact & lightweight 3M™ DBI-SALA® Rollgliss™ R550 System and the ultra easy to control 3M™ DBI-SALA® Rollgliss™ R350 Rescue & Descent Systems.



### 3M™ DBI-SALA® Rollgliss™ R550 Rescue System

#### Emergency Escape

Use the Rollgliss 550 as an escape device when it is imperative to get to the ground as quickly as possible.

#### Assisted Rescue Pick-Off

Use the Rollgliss 550 for an assisted pick-off rescue when a victim is unable to get to safety alone. Lower to the victim and hook up to them and use the device to descend to safety.

#### Assisted Rescue

Attach the Rollgliss 550 to the top of the wind turbine and lower the hook end to the victim and lower them to the ground.

#### Custom Rescue

The Rollgliss 550 can be used in many custom rescue situations. Use the system to repel down the structure to safety.

#### Applications

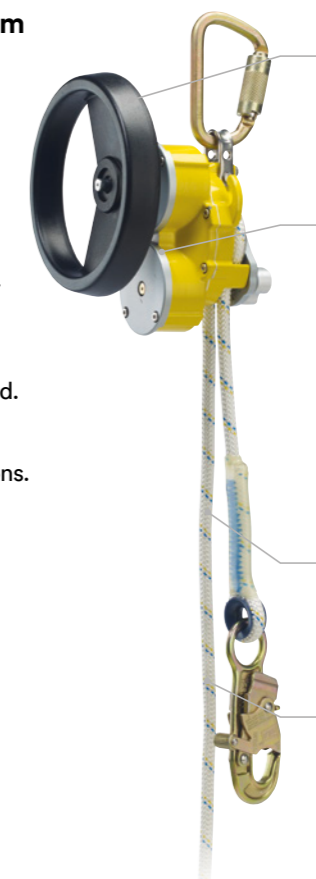

#### Optional Rescue Hub

Allows not only evacuation but also rescue.

#### Bi-Directional Hub

Rope descends from either side which brings one hook up as the other goes down, allowing for immediate use after each descent.

#### Optional Bracket

Allows quick and easy connection to the ladder rung in order to optimise effectiveness of the rescue.

#### Durable Rope

9.5 mm (3/8") static kernmantle rope rated for durability.

#### Multiple Length Options

Lengths from 10 to 175 m for 2 person and from 10 to 500 m for 1 person.

#### Weight Capacity

282 kg

### 3M™ DBI-SALA® Rollgliss™ R550 Rescue System without rescue hub

	←→	kg
Best Seller 3328020		EN 341
3328010	10 m	2.84
3328020	20 m	3.41
3328030	30 m	3.98
3328040	40 m	4.55
3328050	50 m	5.12
3328060	60 m	5.69
3328070	70 m	6.26
3328080	80 m	6.83
3328090	90 m	7.40
3328100	100 m	7.97
3328110	110 m	8.54



Other lengths or longer lengths up to 500 m contact us.

### 3M™ DBI-SALA® Rollgliss™ R550 Rescue System with rescue hub

	←→	kg
Best Seller 3329050		EN 341 EN 1496
3329010	10 m	3.45
3329020	20 m	4.02
3329030	30 m	4.59
3329040	40 m	5.16
3329050	50 m	5.73
3329060	60 m	6.30
3329070	70 m	6.87
3329080	80 m	7.44
3329090	90 m	8.01
3329100	100 m	8.58
3329110	110 m	9.15
3329120	120 m	9.72
3329130	130 m	10.29



Other lengths or longer lengths up to 500 m contact us.

### 3M™ DBI-SALA® Rollgliss™ R350 Rescue System

The Rollgliss R350 system provides efficient hauling, but more importantly, very controlled lowering (a finger and thumb are all that is required to hold a load). This system also allows you to quickly change the hauling ratios on the fly with quick release pulleys, allowing custom rigging for different applications and jobsites.

- Interchangeable pulley system with a 3:1 ratio standard
- Includes everything you'll need for efficient rescue
- Rope retention bar does not allow rope to twist or overlap
- Visual and audible function controls
- Static kernmantle rope for optimum performance
- Quick connect system allows fast insertion of various pulleys
- Weight capacity 150 kg (1 user), 250 kg (2 users)

#### Applications



EN 341  
EN 1496

Best Seller  
AG6350ST31/60

	←→	Ratio	Person	kg
AG6350ST31/30	7.5 m	3:1	1	5.70
AG6350ST31/60	15 m	3:1	1	6.20
AG6350ST51/60	10 m	5:1	2	6.40

### 3M™ DBI-SALA® Rollgliss™ R250 Rescue Kit

The DBI-SALA® Rollgliss™ Rescue Kit is a universal solution for the rescue of a worker remaining suspended after a fall. The kit contains everything you need to perform a rescue within the back pack.

#### The kit contains:

- Rope, 11 mm Nylon
- Recovery hook, aluminium, 60 mm gate
- R250 Rescue descender, easily controlled with anti-panic function that eliminates the risk of accidents caused by incorrect handling
- Telescopic rod, 5 m
- Anchorage rig with protection system
- Rigging system, ability to raise worker and disconnect the fall-arrest equipment



#### Usage limits:

- 1 person
- Max. weight capacity: 150 kg (min. weight 30 kg)
- Descent: Max 100 m

#### Conforms to:

- EN 341 Class A standard
- \*This conformity is valid only with AG6250ROPE

EN 341

	←→	kg
AG62501010	10 m	6.10
AG62501020	20 m	6.60
AG62501030	30 m	7.10

### 3M™ DBI-SALA® Aluminium Tripod



CE EN795 CLASS II

	←→	kg
KM1PT7	2.13	22.0

Lightweight, durable aluminium construction. Includes quick connect winch mount bracket and top mounted pulley system. Telescoping adjustable locking legs for easy set-up. Fast decent pin style adjustment and locking. Rubber safety shoes with spiked edges for different terrains. Built-in head-mounted anchor points. Winch not included – please order separately.

### Aluminium Tripod



CE EN795 TYPE F

	kg	kg
AM100	500 kg	19.00

For tasks in a confined space, a reliable anchorage point must be used to allow work to be carried out effectively and in complete safety. This aluminium mobile tripod can be easily transported and deployed. Four independent anchorage points mean that a rig for suspended work can be used in combination with a self-retracting fall arrest device that incorporates a retrieval system, fall arrest and rescue equipment. 8 adjustable positions. Usage height 1.35 m to 2.35 m. Base dia. 1.50 m to 2.56 m.

### 3M™ DBI-SALA® Winch



Best Seller  
KT2PW60L

EN 1496

	←→	∅	⊙	kg
KT2PW60L	18 m	5 mm	⊙	16.00
KT2PW120L	36 m	5 mm	⊙	17.52

Lightweight winch for rescue.

- 6:1 gear ratio allows average lifting speed of 3.9 m / minute
- Incorporated quick mounting bracket for direct attachment to tripod
- Automatic clutch/brake

### 3M™ DBI-SALA® Rope Control Device



CE EN567

	kg
AG6800260B - with brake	0.40
AG6800260 - without brake	0.27

### Rescue Winch



EN 1496

	⊙	∅	←→	kg
AT200/120	5 mm	5 mm	20 m	10.10

Designed for rescue purposes in confined spaces. The integrated fixing plate means it can be easily mounted on the AM100 mobile tripod. Its reduction ratio of 4.1/1 means a victim can be rapidly retrieved. N.B. A rescue winch should always be used together with a fall arrest system.

### Steel Guide Pulley



	kg
AT052/1	0.91

Complete pulley with AJ501 Carabiner.

### 3M™ DBI-SALA® Rollgliss™ Carrying Bag



	←→	kg
AG6800621	up to 100 m	0.85
AG6800622	up to 250 m	1.19

3M™ DBI-SALA® Davit Arm Systems are designed for manhole and confined space entry/retrieval applications.

These units are constructed of lightweight materials including high-strength aluminium. The davit pivots for ease-of-rescue and has adjustment for overhead clearance restrictions. The lower base adjusts to fit most standard entries. Many other portable and fixed bases are available to suit any jobsite need.

### Applications



3M™ DBI-SALA® Short Reach Davit Arm High Capacity (14" - 28")

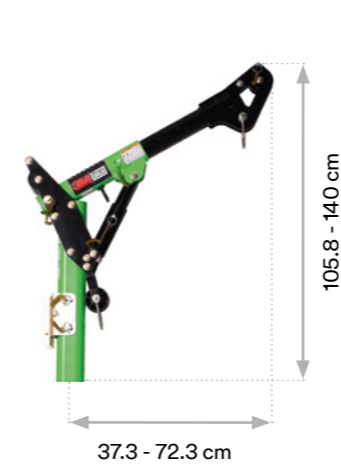

CE EN795 TYPE B

Model	Capacity	Weight (kg)
8000107	S	16.50

Includes Short Reach Offset Arm High Capacity (8000110) and Universal Lower Mast High Capacity (8000109).

3M™ DBI-SALA® Long Reach Davit Arm High Capacity (27" - 44")

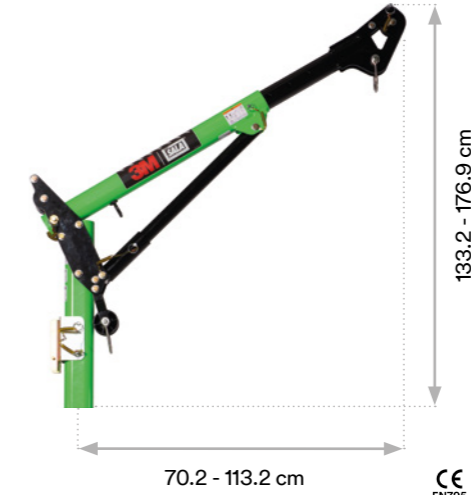

CE EN795 TYPE B

Model	Capacity	Weight (kg)
8000108	L	19.20

Includes Long Reach Offset Arm High Capacity (8000111) and Universal Lower Mast High Capacity (8000109).

3M™ DBI-SALA® Universal Lower Mast High Capacity



Model	Capacity	Weight (kg)
8000109	Universal	10.10

Includes one winch mounting bracket.

3M™ DBI-SALA® 5 Piece Short Reach Davit High Capacity (HC)

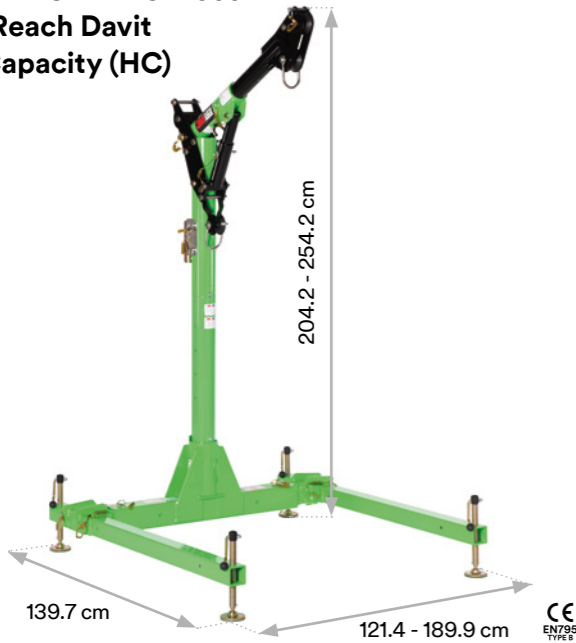

CE EN795 TYPE B

Model	Capacity	Weight (kg)
8000118	S	65.30

Includes Short Reach Davit Arm High Capacity (8000107), 84 cm Mast Extension (8000113) and Short Reach 3 Piece Davit High Capacity Base (8000104). Includes 1 winch mounting bracket.

3M™ DBI-SALA® 5 Piece Long Reach Davit High Capacity (HC)

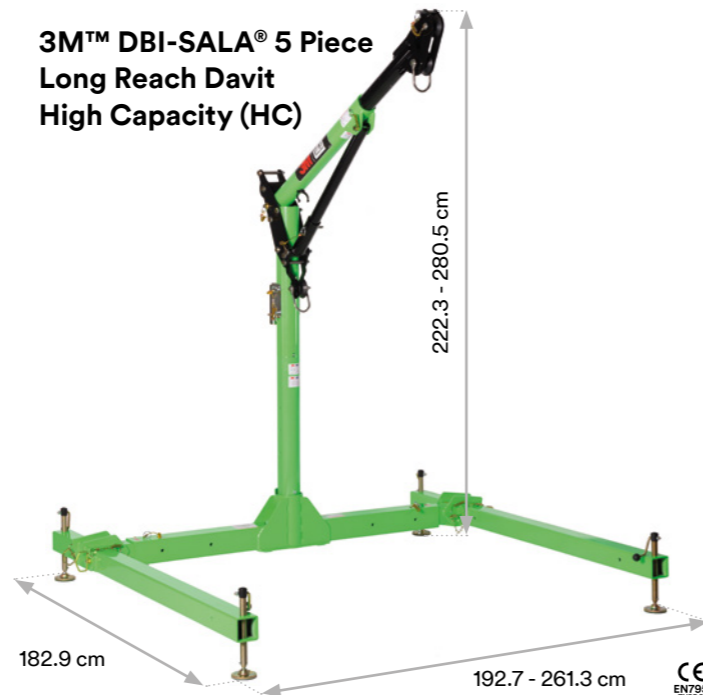

CE EN795 TYPE B

Model	Capacity	Weight (kg)
8000119	L	81.60

Includes Long Reach Davit Arm High Capacity (8000108), 84 cm Mast Extension (8000113) and Long Reach 3 Piece Davit High Capacity Base (8000105). Includes one winch mounting bracket.

3M™ DBI-SALA® Short Reach Offset Arm High Capacity (14" - 28")



CE EN795 TYPE B

Model	Capacity	Weight (kg)
8000110	S	6.40

3M™ DBI-SALA® Long Reach Offset Arm High Capacity (27" - 44")



CE EN795 TYPE B

Model	Capacity	Weight (kg)
8000111	L	9.10

3M™ DBI-SALA® Davit Mast Extensions High Capacity

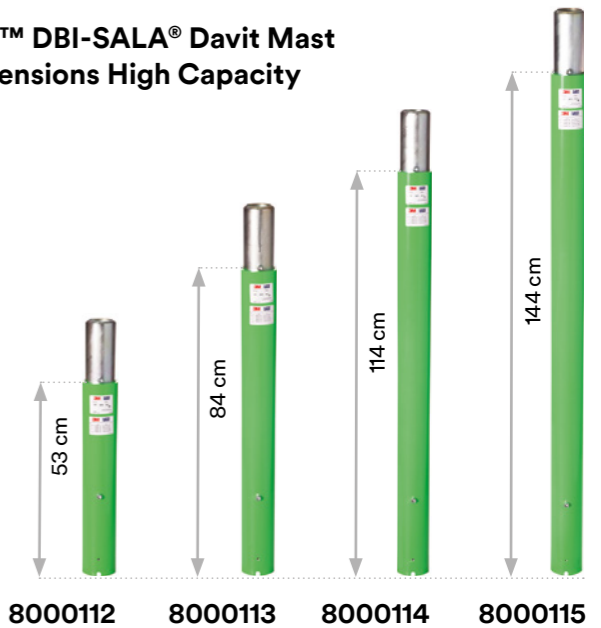

Model	Length (cm)	Weight (kg)
8000112	53 cm	8.40
8000113	84 cm	10.90
8000114	114 cm	13.30
8000115	144 cm	15.70

Only one mast extension allowed for short reach or long reach davit arm.

**3M™ DBI-SALA® 3 Piece Short Reach Davit Base High Capacity**

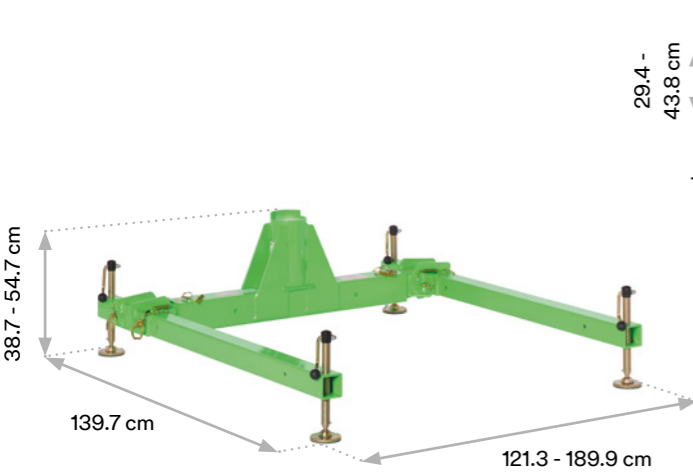

EN 795 TYPE B		
	←.....→	kg
8000104	S	37.50

**3M™ DBI-SALA® 3 Piece Long Reach Davit Base High Capacity**

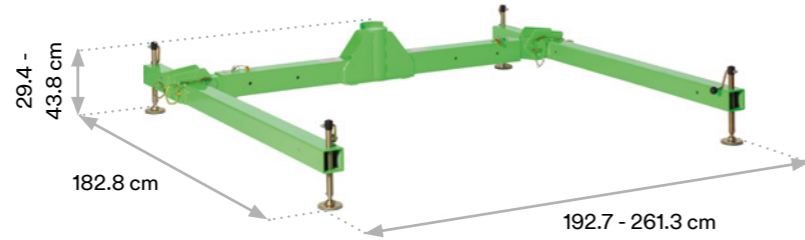

EN 795 TYPE B		
	←.....→	kg
8000105	L	50.50

**3M™ DBI-SALA® Floor Mount Base High Capacity**

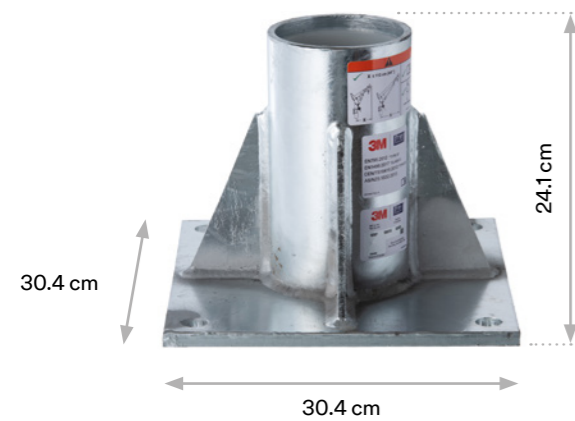

EN 795 TYPE A		
	Description	kg
8000095	Galvanised steel	15.60
8000096	Stainless steel - 304	15.60

Mounts to horizontal concrete or steel structure. Comes with PVC sleeve liner.

**3M™ DBI-SALA® Wall Mount Base High Capacity**



EN 795 TYPE A		
	Description	kg
8000101	Galvanised steel	15.70
8000102	Stainless steel - 304	15.70

Compact design creates minimum intrusion into work space. Mounts to vertical concrete or steel structures. Comes with PVC sleeve liner.

**3M™ DBI-SALA® Flush Core Mount Base High Capacity**

EN 795 TYPE A		
	Description	kg
8000089	Galvanised steel	5.40
8000090	Stainless steel - 304	5.20

Designed for slip-in installation into a Ø128.5 cm (5.06") core hole in concrete. Comes with PVC sleeve liner.



**3M™ DBI-SALA® Flush Core Mount Base High Capacity with Top Plate**

EN 795 TYPE A		
	Description	kg
8000091	Galvanised steel	12.40
8000092	Stainless steel - 304	12.20

Recessed fastener pockets allow for bolt-in installation into existing concrete. Flush mount design allows passage of traffic and eliminates trip hazards when not in use. Comes with PVC sleeve liner.

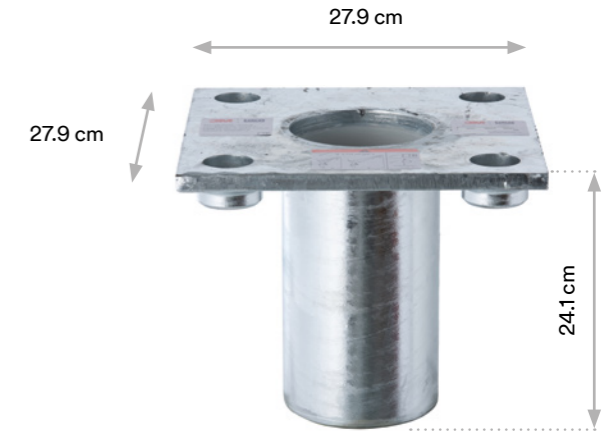

**3M™ DBI-SALA® Deck Mount Base High Capacity**

EN 795 TYPE A		
	Description	kg
8000099	Galvanised steel	14.60
8000100	Stainless steel - 304	14.50

Designed to slip into a 128.5 mm (5.06") hole in existing steel structure flooring. Comes with the necessary hardware to mount to structures with a maximum thickness of 89 mm (3.50").

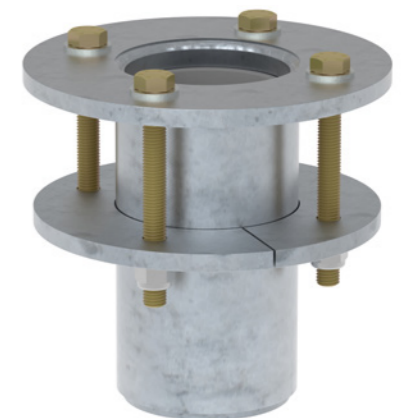

The 3M™ DBI-SALA® Counterweight System comprises a central counterweight cart with wheels connected by a bar to the davit base.

Despite its weight, the unit can be easily moved to different locations within the plant, with all components of the system being placed vertically on the cart.

Note: Individual weight plates sold separately - see below for more info.

**Applications**



**3M™ DBI-SALA® Counterweight Base High Capacity with Cart**

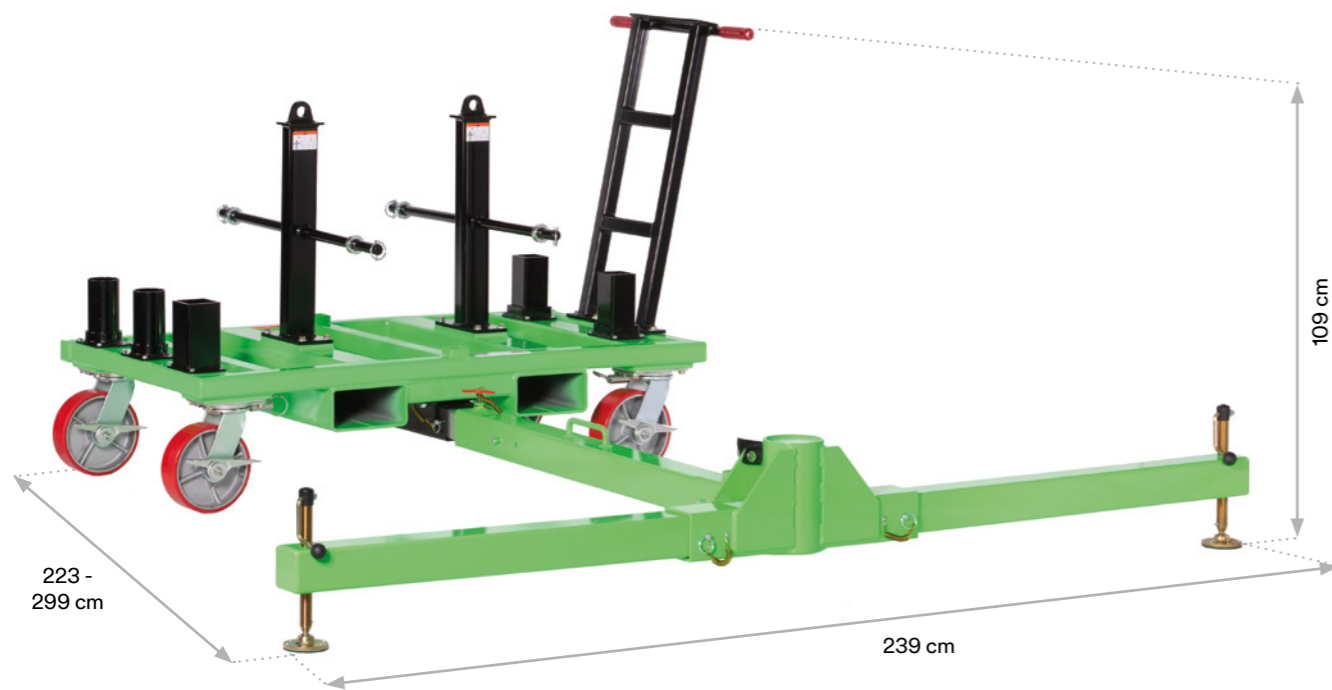

- Compatible with short and long reach davit arms
- Requires a quantity of 20 (for short reach) or 36 (for long reach) 20 kg athletic weight plates (to be ordered separately, reference 8000123)
- All base components required included
- Built-in forklift pocket and lifting rings for easy transport
- Horizontal weight arrangement is more ergonomic and safer
- Mast / davit storage included
- Swivel lock and brake wheels.

<b>8000106</b>	<b>241.00</b> kg

The 3M™ DBI-SALA® Pole Hoist attaches with a carabiner to a suitable anchor point, allowing you to work in any direction from any angle.

The 3M DBI-SALA Pole Hoist System features a swivel head that rotates 360 degrees, providing unparalleled flexibility in both vertical and horizontal confined-space entries. Overall length adjusts from either 1.2 - 2.13 m (4' - 7') or 1.8 - 3.05 m (6' - 10') for positioning attendant for working in close quarters.

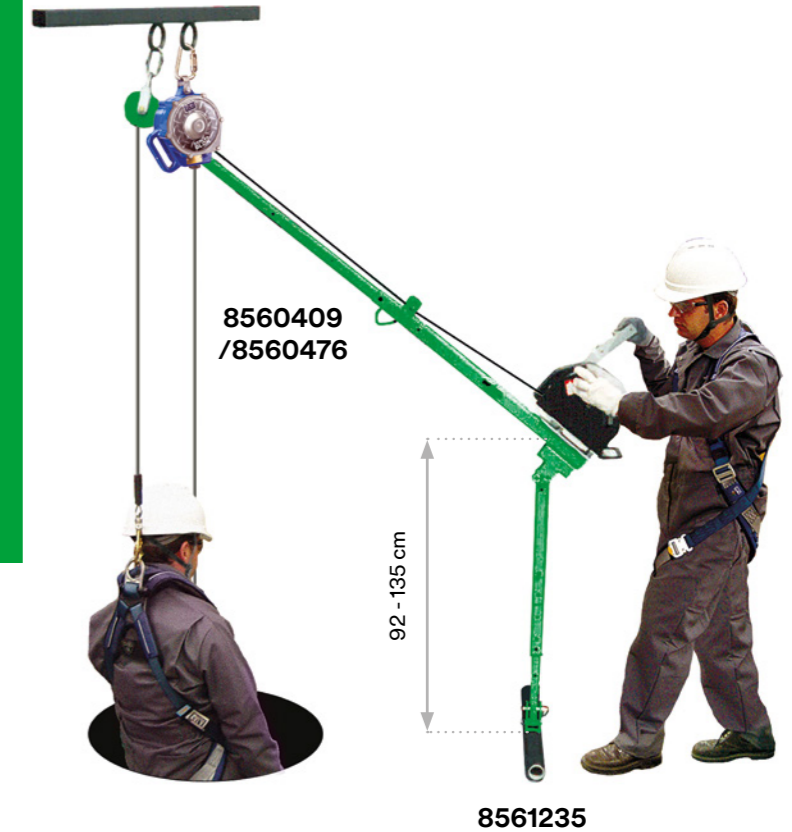

**3M™ DBI-SALA® Pole Hoist System**

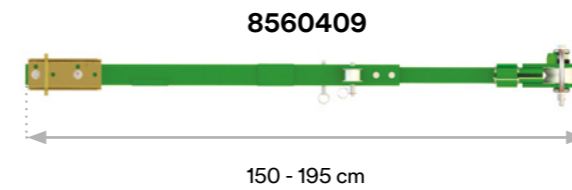

<b>8560409</b>	
	<b>5.40</b> kg
1.2 - 2.13 m (4' - 7') Extendible Pole Hoist, swivel head & stainless steel hardware. Includes winch bracket.	

**3M™ DBI-SALA® Pole Hoist System**

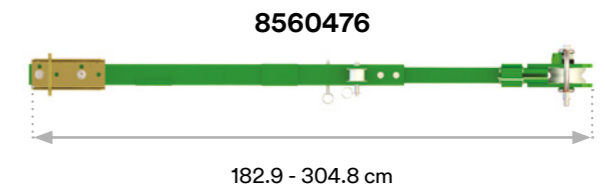

<b>8560476</b>	
	<b>6.35</b> kg
1.8 - 3.05 m (6' - 10') Extendible Pole Hoist, swivel head & stainless steel hardware. Includes winch bracket.	

**Accessory Options**

	Description	kg
<b>8561235</b>	T-bar leg assembly with stainless steel hardware (required)	3.40
<b>8513329</b>	Carrying Bag for 1.2 - 2.13 m (4' - 7') Pole Hoist	
<b>8513330</b>	Carrying Bag for 1.8 - 3.05 m (6' - 10') Pole Hoist	

The 3M™ DBI-SALA® Portable Fall Arrest Post is specifically designed for use on top of transformers or other types of vertical platforms with potential fall hazards.

It's compact and lightweight design of only 17.2 kg (38 lbs) makes the post very easy to transport and put in place. The system features 3 independent swivel anchor points. They can rotate 360 degrees, offering freedom of mobility for up to 3 workers with self-retracting lifelines or fixed length lanyards. The 3M DBI-SALA Portable Fall-Arrest System has 3 telescopic working heights ranging from 774 mm (30.5") 1092 mm (43"), all the way up to 1384 mm (54.5"). This decreases a worker's fall distance and increase the overall work area.

3M™ DBI-SALA® Portable Fall Arrest Post



1st Position Fully Collapsed

2nd & 3rd Positions Partially Extended

4th Position Fully Extended

	Description	kg
8566691	Portable fall arrest post	17.20



3M™ DBI-SALA® Concrete Anchor Plate



	EN 795 TYPE A
8569819	19.50

3M™ DBI-SALA® Portable Fall Arrest System Anchor Base with Tie-Off Anchor



	Description	kg
8567412	To be welded, bare steel	5.60
8567422	To be welded, sandblasted bare steel to be painted	5.60



3M™ DBI-SALA® ISO Container Fall Arrest Post



	kg
8563161	12.00

Compatible with all ISO certified containers. Provides an elevated anchorage point reducing fall clearance requirements. Ensures total fall protection solution, even while working on a single container. No tools or container modification required.

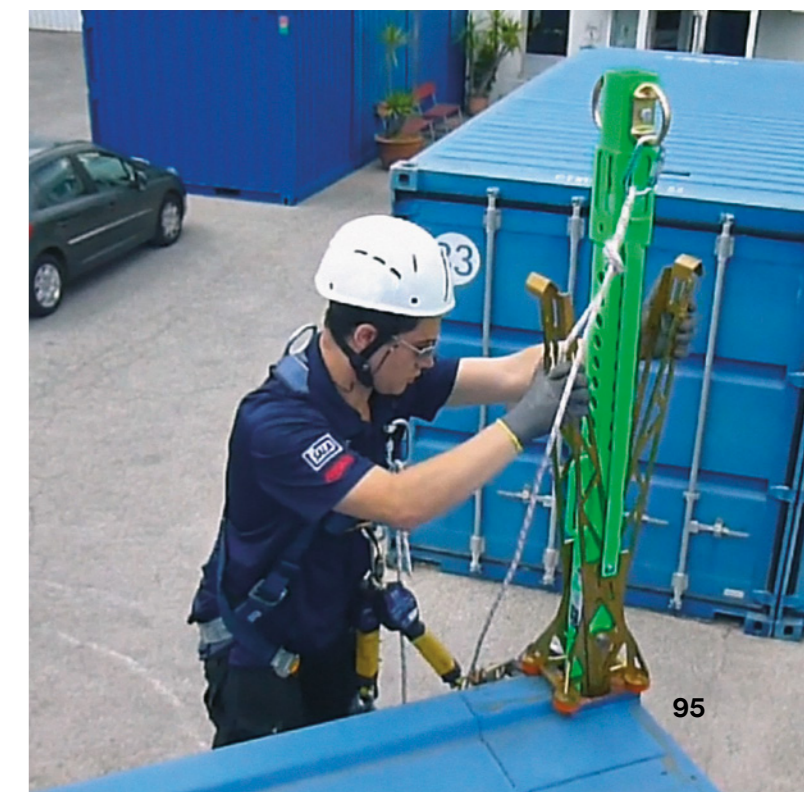

The 3M™ DBI-SALA® Vehicle Hitch Mount Sleeve is designed to connect to an attendant vehicle with a hitch ball coupler to provide a portable anchor point for confined space entry/retrieval, rescue and fall-arrest systems.

### 3M™ DBI-SALA® Vehicle Hitch Mount Base High Capacity



8000103	40.80
---------	-------

- Compatible with short and long reach davit arm
- All base components required and hitch ball coupler included
- Full length adjustable
- All aluminium components for lightweight
- Adjustable screw feet

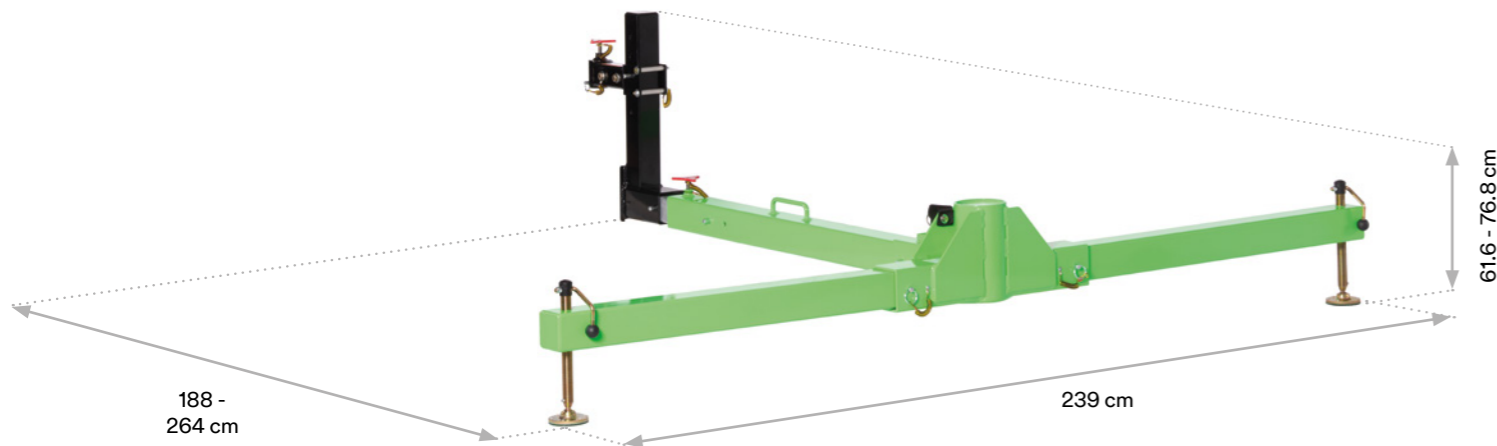

### 3M™ DBI-SALA® Extended Height Vehicle Hitch Adjustment

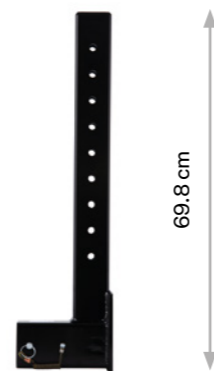

8000116	4.00
---------	------

### 3M™ DBI-SALA® UCT-300 Aluminium Tripod



8563158	21.60
---------	-------

2.13 m (7 ft.) Tripod with adjustable locking legs, safety chains, top pulley & winch bracket. Weight capacity 205 kg. Note: Winch and SRL not included.



### 3M™ DBI-SALA® UCT-1000 Aluminium Tripod

Best Seller  
8563159



8563159	30.80
---------	-------

3.048 m (10 ft.) Tripod with adjustable locking legs, safety chains, top pulley & winch bracket. Note: Winch and SRL not included.

### 3M™ DBI-SALA® Series 100 Digital Winches

3M™ DBI-SALA® Series 100 Digital Winches are rated for a maximum working load of 204 kg (450 lbs) with an 11:1 safety factor. This winch has two cranking speeds capable of retrieval/descent from 4 m/min (13 ft/min) to 9 m/min (30 ft/min). Available in 3 standard sizes. All cable/rope assemblies come with a double locking swivel snap hook with overload indicator.



Best Seller  
8518558

		Actual Length	Working Length	kg
8518560	G	21.3 m	18 m	13.80
8518558	SS	21.3 m	18 m	13.84
8518561	G	30 m	27 m	14.70
8518559	SS	30 m	27 m	14.74

### 3M™ DBI-SALA® Overload Protection Clutch



8512936	0.68
---------	------

Features a maximum working load of 204 kg (450 lbs.). Use with cordless drill 0-300 RPM, 45 N.m torque minimum. For use only with specific winch, please contact 3M.

**3M™ DBI-SALA® Winch Mounting Bracket for Davit Arm High Capacity**

**3M™ Protecta® Retrieval SRL Mounting Bracket**

8000117	2.00 kg
---------	---------

Quick release mounting bracket with flat back adapter for winch / SRL for 3M™ DBI-SALA® Davit Arm High Capacity.

3590499	For 15 m SRL	0.70 kg
---------	--------------	---------

Attaches to 3M™ Protecta® Retrieval SRL model, supplied with mounting bolts, mates with 8000117.

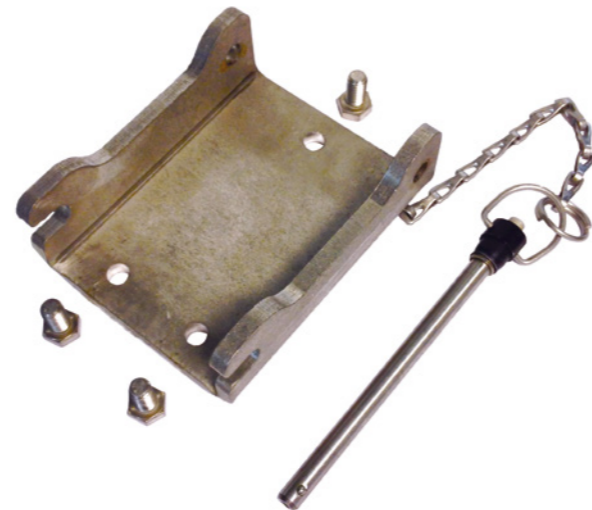
**3M™ DBI-SALA® Sealed-Blok™ Mounting Bracket**

3401025	For 9 m, 15 m and 25 m SRL	0.70 kg
---------	----------------------------	---------

Attaches to 3M™ DBI-SALA® Sealed-Blok™, supplied with mounting bolts, mates with 8510207.



For more information on working in Confined Spaces, visit [www.3m.co.uk/confinedspaces](http://www.3m.co.uk/confinedspaces)



# 3M™ DBI-SALA® Flexiguard™ Modular Jib Systems.



Exceptional configuration compatibility.  
Improved transportability. Helps you work safely.

Get the coverage you need with this versatile new fall protection system. Available in both the M100 and M200 Series, the 3M™ DBI-SALA® Flexiguard™ Modular Jib System features a simplified design that enhances worker safety in multiple applications. Increased rail-length configurations improve working coverage while a new design facilitates easier system transportation.

More versatility. New modular product offering provides 80 unique application solutions.

## Applications



## Height Access Systems

- Extruded aluminium overhead horizontal rail for SRL trolley
- Stainless steel anchor trolley
- Dual by-passing rails (two user models)

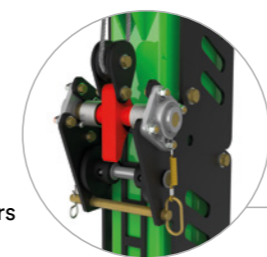

### Fail-safe mast lock

- Eliminates need for height-locking fasteners like pins and bolts
- Automatic safety lock engages to prevent uncontrolled mast movement if primary lifting mechanism fails
- Flip up rotation handle
- Improve productivity with the optional power assisted device. When equipped, it adjusts height four times faster than the manual adjustment of previous 3M models
- Rotating mast up to 360 degrees (most models)
- 3M™ Safety-Walk™ Slip Resistant walking surface (counterweight bases)
- Powder coated and galvanised components

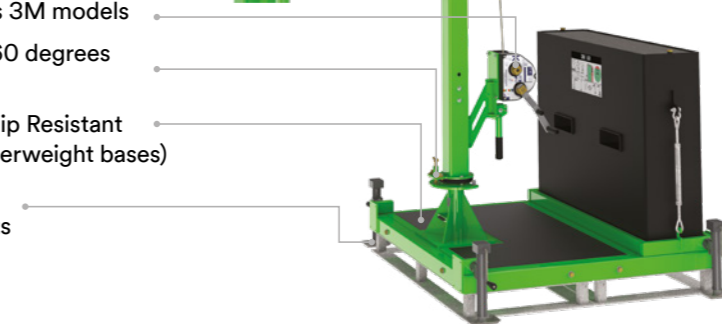

### Extended reach

- New M200 version offers improved reach on 4.6 m (15 ft.) configurations enabling up to 3.7 m (12 ft.) more reach than previous models

### Increased height

- Improved maximum height for 9.1 m (30 ft.) models enables up to 1.5 m (5 ft.) more vertical height versus previous models
- Semi-fixed models come with 1.5 m (5 ft.) of height adjustment for maximum flexibility during field installations
- Removable counterweight box (counterweight bases) with built in fork pockets and lifting ring attachment points (sold separately)
- Integrated levelling bubbles (counterweight bases)
- Open multi-directional base designed to accommodate a wide array of fork shapes and sizes

## Enhanced safety working area.

- Extended rail-lengths increase safe working area coverage
- Reduces risk of potential swing fall hazards - worker and safety manager can visually verify the straight vertical boundary
- Simplifies fall clearance requirements

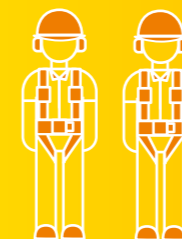

### Dual user rated

Select M200 models only

- Helps increase worksite efficiency and safety for multiple workers
- Provides additional working coverage compared to previous 3M models
- Dual user systems contain two independent bypassing horizontal rails rated for one worker each

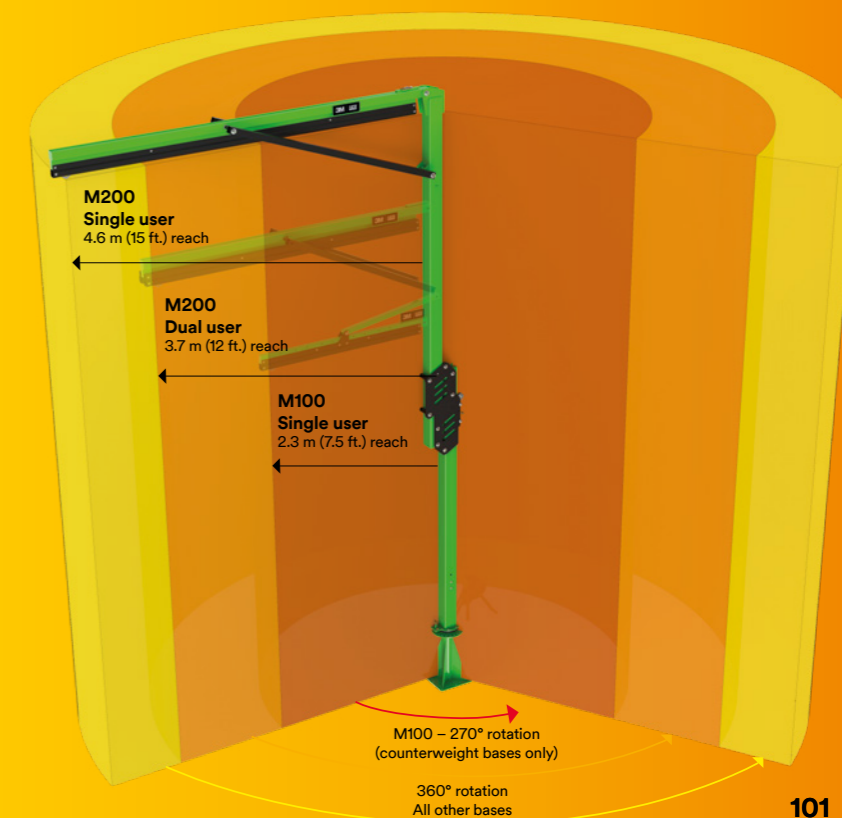

3M™ DBI-SALA® Flexiguard™ M100 Modular Jib Systems

EN 795 TYPE

Model	Total system weight	Max. component weight	Offset/Reach (A)	Height (B)	Mast rotation range	Max. number of users	SRL maximum arresting force
M100	2,266 kg (4,995 lbs.)	1,404 kg (3,095 lbs.)	2.3 m (7.5 ft.)	Up to 9.1 m (30 ft.)	270° with counterweight base 360° with others	1	6 kN (1,350 lbs.)

1 Choose from 7 interchangeable mast options.

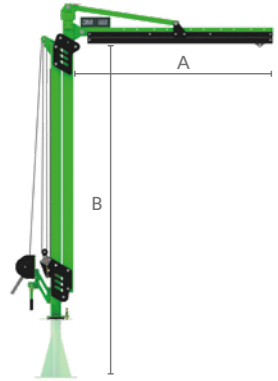

Adjustable height, single user masts

- 8530874 3 - 4.6 m (7.5 - 15 ft.)
- 8530875 3.8 - 6.1 m (12.5 - 20 ft.)
- ▶ 8530876 4.6 - 7.6 m (15 - 25 ft.)
- 8530877 5.3 - 9.1 m (17.5 - 30 ft.)

Adjustable height masts are adjusted easily using the integrated hand crank winch, or by using a power drill with the optional overload clutch accessory equipped.

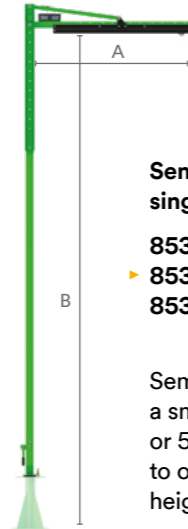

Semi-fixed height, single user masts

- 8530882 4.6 - 6.1 m (15 - 20 ft.)
- ▶ 8530883 6 - 7.6 m (20 - 25 ft.)
- 8530884 7.6 - 9.1 m (25 - 30 ft.)

Semi-fixed masts offer a small amount (1.5 m or 5 ft.) of adjustment to optimise the anchor height during installation.

▶ = Model shown

2 Choose from 5 interchangeable base options.

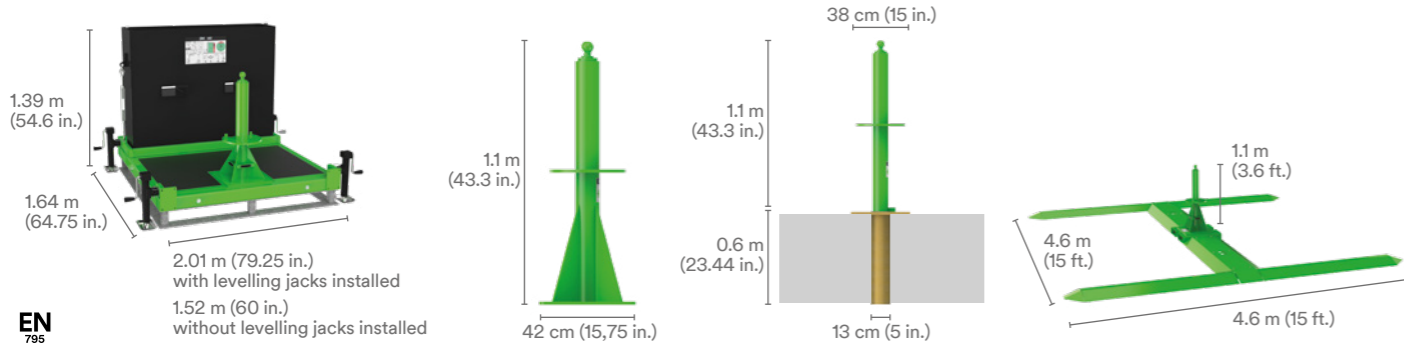

EN 795 TYPE

**Portable Counterweight Base\***  
with concrete fill 8530870  
without concrete 8530869

**Floor Mounted Base**  
8530871

EN 795 TYPE A

**Flush Mounted Base**  
8530872

EN 795 TYPE A

**Outrigger Base**  
8530873

CE EN795 TYPE B

\*Portable Counterweight Base includes levelling jacks

3 Choose your accessories.

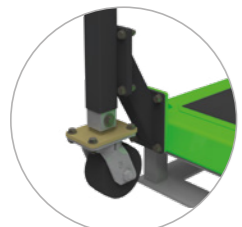

**Smooth Surface Caster Kit**  
8530908  
Allows counterweight base systems to be manoeuvred into tight spaces on smooth surfaces, kit of 4 wheels.



**Forklift Pocket Mast Transport Kit\*\***  
8530911  
Allows mast to be separated from the base and transported vertically using a forklift.  
\*\* Only for adjustable masts.



**Overload Clutch**  
8512936  
Required to raise and lower adjustable masts with a power drill (drill not included).



**Counterweight Box Lifting Ring Kit**  
8530914  
Allows counterweight box to be moved with overhead lifting equipment. Includes two rings per kit. One kit needed per counterweight system.

3M™ DBI-SALA® Flexiguard™ M200 Modular Jib Systems

EN 795 TYPE

Model	Total system weight	Max. component weight	Offset/Reach (A)	Height (B)	Mast rotation range	Max. number of users	SRL maximum arresting force
M200	5,746 kg (12,668 lbs.)	2,268 kg (5,000 lbs.)	4.6 m (15 ft.) Single user models 3.7 m (12 ft.) Dual user models	Up to 9.1 m (30 ft.)	360° for all bases	1 or 2 depending on model	6 kN (1,350 lbs.)

1 Choose from 14 interchangeable mast options.

▶ = Model shown

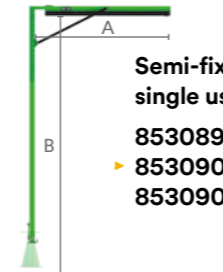

Semi-fixed height, single user masts

- 8530899 4.6 - 6.1 m (15 - 20 ft.)
- ▶ 8530900 6.1 - 7.6 m (20 - 25 ft.)
- 8530901 7.6 - 9.1 m (25 - 30 ft.)

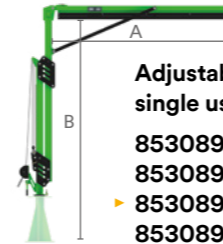

Adjustable height, single user masts

- 8530891 3.8 - 4.6 m (12.3 - 15 ft.)
- 8530892 4.5 - 6.1 m (14.8 - 20 ft.)
- ▶ 8530893 5.3 - 7.6 m (17.3 - 25 ft.)
- 8530894 6 - 9.1 m (19.8 - 30 ft.)



Semi-fixed height, dual user masts

- 8530902 4.6 - 6.1 m (15 - 20 ft.)
- ▶ 8530903 6.1 - 7.6 m (20 - 25 ft.)
- 8530904 7.6 - 9.1 m (25 - 30 ft.)

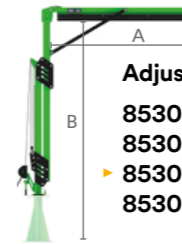

Adjustable height, dual user masts

- 8530895 3.8 - 4.6 m (12 - 15 ft.)
- 8530896 4.5 - 6.1 m (14.8 - 20 ft.)
- ▶ 8530897 5.3 - 7.6 m (17.3 - 25 ft.)
- 8530898 6 - 9.1 m (19.8 - 30 ft.)

Semi-fixed masts have a small amount (1.5 m or 5 ft.) of adjustment to optimise the anchor height during installation.

Adjustable height masts are adjusted easily using the integrated hand crank winch, or by using a power drill with the optional overload clutch accessory equipped.

2 Choose from 4 interchangeable base options.

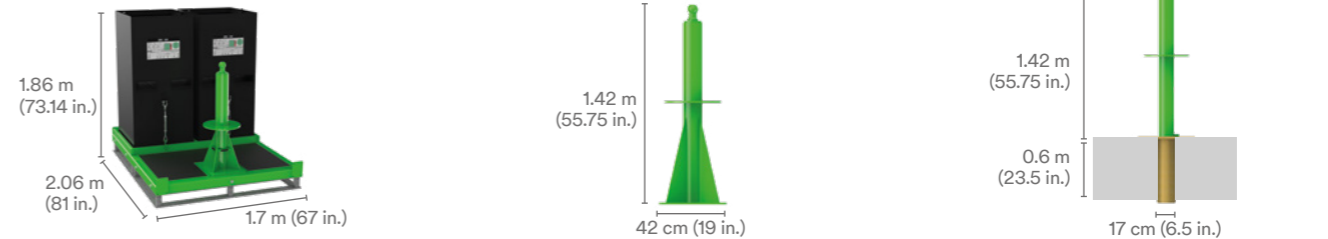

**Portable Counterweight Base\***  
With concrete fill 8530887  
Without concrete 8530886

EN 795 TYPE

**Permanent Floor Mounted Base**  
8530888

EN 795 TYPE A

**Permanent Flush Mounted Base**  
8530889

EN 795 TYPE A

\*Portable Counterweight Base optional levelling jacks sold separately

3 Choose your accessories.

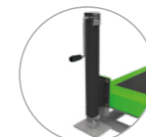

**Jack Stabilising Kit**  
8530907  
Designed to stabilise and level counterweight base systems on slightly uneven surfaces, kit of 4 jacks.

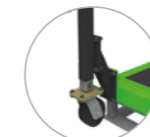

**Smooth Surface Caster Kit**  
8530908  
Allows counterweight base systems to be manoeuvred into tight spaces on smooth surfaces, kit of 4 wheels.



**Forklift Pocket Mast Transport Kit\*\***  
8530912  
Allows mast to be separated from the base and transported vertically using a forklift.  
\*\* Only for adjustable masts.



**Overload Clutch**  
8512936  
Required to raise and lower adjustable masts with a power drill (drill not included).



**Counterweight Box Lifting Ring Kit**  
8530777  
Allows counterweight box to be moved with overhead lifting equipment. Includes four rings per kit. One kit needed per counterweight system.

3M™ DBI-SALA® Vacuum Anchor provides a tie-off point on virtually any smooth, non-porous surface simply by flipping a switch and waiting for the green light.

Lightweight design (under 10 kg) for easy transport. Fail-safe back-up systems with audio alarms and vacuum level indicator. Rubber seals secure anchor without damaging surface. Weight capacity 136 kg. Can be used with horizontal lifeline systems for added mobility for up to four workers.

Applications



3M™ DBI-SALA® Vacuum Anchor \*Primary Unit with Bottle Attachment



CE EN795 TYPE B

2200126	10.46
---------	-------

3M™ DBI-SALA® aviation industry self-contained vacuum anchor assembly with bottle attachment and carrying case. It is powered up with a single, on-board 0.8 litre compressed gas bottle (order separately) or a large capacity detached bottle, or shop air. Unit can also power one additional secondary pad.

3M™ DBI-SALA® Vacuum Anchor \*Primary Unit without Bottle Attachment



CE EN795 TYPE B

2200125	8.00
---------	------

Aviation industry self-contained vacuum anchor without bottle attachment for situations where shop air is always available. Unit can also power one additional secondary pad.

3M™ DBI-SALA® Vacuum Anchor \*Secondary Unit without Bottle Attachment



CE EN795 TYPE B

2200127	6.80
---------	------

Aviation industry self-contained vacuum anchor secondary pad for connection to a primary pad.



\*All vacuum anchors come with a case

3M™ DBI-SALA® Vacuum Anchor Accessories

	Description	kg
2200085	Compressed Air Bottle	1.46
2200086	Fill Station - Air bottle CE marked 0.8l, 2068kPa (300psi)	0.90
2200087	Scuba Adaptor - To fill gas bottle from bulk air storage tank	1.50
2200130	Secondary Pad Hose Assembly	2.10

Note: These are non-stocked items. Please ask your Customer Services representative for a delivery lead time.

3M™ DBI-SALA® Detent Wall Anchor



CE 2016 755

	kg
2101005	0.45
2101001	0.16
2101003	0.25

Assembly comprising detent pin, socket, M6 allen key and cover cap. Use for floor, wall or ceiling type applications. Provides convenient tie-off points wherever needed. Push-button operation for fast and easy operation. Socket includes cover cap to hide recess, blending into the decor.

3M™ DBI-SALA® Window & Door Jamb Anchor



CE EN795 TYPE B

	kg
2100080	6.36

With 55 cm to 130 cm width adjustment. Non-penetrating design ensures no damage to structure. The anchor is simply compressed between the vertical sides of the door or window. Fast and easy installation with built-in adjustment knob - no tools or drilling are required.

3M™ DBI-SALA® Concrete D-ring Anchor



EN 795 TYPE A

		kg
2104565	1	0.50
2104566	6	0.60
2104567	12	3.00

Reusable D-Ring assembly. Rugged design for harsh environments. Safe 'hook-up' indicator notifies user of proper installation. Install into 18 mm holes - only standard drill bits needed.

3M™ DBI-SALA® Sliding Beam Anchor



CE EN795 TYPE B

		kg
2104711	8.9 to 35.6 cm and 3.2 cm thick	1.59
2104716	30.5 to 76.2 cm and 6.3 cm thick	3.40

Secure the anchor to the beam using the redesigned adjustment buttons, simply connect your Self-Retracting Lifeline (SRL) or lanyard to the swivelling D-ring and you're ready to work. The anchor point slides effortlessly behind you. Set of 2 replacement wear pads available; 2110815 (small), 2110816 (large).

**3M™ DBI-SALA® Fixed Beam Anchor**

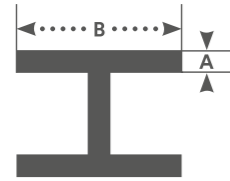

Anchor beam dimensions chart

	A	B	kg
2108412	3.81 cm	6.35 - 30.48 cm	2.40
2108413	3.81 cm	6.35 - 45.72 cm	2.70
2108414	3.81 cm	6.35 - 60.92 cm	3.00
2108415	6.35 cm	30.48 - 91.44 cm	4.00

Installs in seconds to the beam structure in any orientation, with final tightening using a built-in adjustment handle.

**3M™ DBI-SALA® I-Beam Trolley Anchor - Adjustable**



Note: SRL not included

Part Number	Weight (kg)
2103148	6.80

The trolley is for use with self retracting lifelines on horizontal beams and has been engineered for ease-of-use and superior performance. Glides effortlessly along the beam and provides horizontal mobility. Attachable anywhere along beam, including midpoint. Non-corrosive double-shielded wheel bearings are maintenance free. Trolley Guards protect the wheels from damage and keep beam clear of debris.

**3M™ DBI-SALA® Polyester Webbing Sling**



	W	H	kg
KM418	45 mm	83 cm	0.46
KM419	45 mm	90 cm	0.47
KM421	45 mm	200 cm	0.86

Sling Polyester Webbing and stainless steel links. Choke back facility on KM419 & KM421.

**3M™ Protecta® Fixed Anchorage Plate**



Part Number	Weight (kg)	EN 795 TYPE A	EN 795 TYPE A
AM210	0.04	Best Seller	
AM211	0.13		

12 mm fixing. 3 mm thick.

**3M™ Protecta® D-ring Anchorage**



12 mm fixing. Can be used in 3 load directions.

**3M™ DBI-SALA® First-Man-Up™ Remote Anchoring System**



	Length	Description	Weight (kg)
2100094	1.80 - 7.80 m	Telescopic Rod	4.00
2100105	60 mm	Rod Connector	0.30

The telescopic rod connector allows you to attach a rope life line up to 8 m above the user, enabling the user to ascend a pylon or to reach the top of a pole in complete safety.

**3M™ DBI-SALA® Freestanding Rooftop Counterweight Anchor**



Part Number	Description	Weight (kg)
2100180	Counterweight anchor	327.00

Part Number	Description	Weight (kg)
2104190	Counterweight anchor lifting sling	8.60

The rooftop freestanding counterweight anchor does not require attachment to a working surface and provides a safe and versatile fall arrest rated tie-off point.

**3M™ Protecta® Galvanised Steel Sling**



	Length	Ø	Weight (kg)
AM401G	1 m	6 mm	0.29
AM402G	2 m	6 mm	0.47

Thimble ends and PVC protective sleeve.

**3M™ Protecta® Nylon Webbing Sling**



	Width	Length	Weight (kg)
AM450/60	25 mm	60 cm	0.06
AM450/80	25 mm	80 cm	0.07
AM450/100	25 mm	100 cm	0.11
AM450/150	25 mm	150 cm	0.25

Four safety seams.

**3M™ Protecta® Polyester Edge Tested Webbing Sling**



	Width	Length	Weight (kg)
2100205	25 mm	80 cm	0.15
2100206	25 mm	100 cm	0.25
2100207	25 mm	150 cm	0.25
2100208	25 mm	200 cm	0.30

Rigorously tested over a 0.5 mm radius edge.

**3M™ DBI-SALA® EZ-Line™ Temporary Horizontal Lifeline**

EZ-Line is a temporary horizontal lifeline system that is user friendly and extremely fast to install. The innovative retractable design of EZ-Line eliminates large and bulky coils of cable that are difficult to set-up, relocate and store. Built-in winch for fast and easy set-up, use and dismantling. Customise length in any increment up to 18.25 m. Built-in pre-tension and impact indicators for easy set-up and inspection. Extremely lightweight, 33% lighter than conventional systems.

**Applications**



**3M™ Protecta® Pro-Line™ Portable Horizontal Lifeline System**

Portable, versatile and quick to install. There is no connecting or swaging of components, simple ratchet handle to tension the lifeline. No separate components, just connect to suitable anchorage point. Lightweight and easy to handle, incorporated carry bag. Built in shock absorber reduces end loadings to preserve the structure. Max. weight capacity 2 x 141 kg.

**Applications**



	←-----→	kg
1200106	10 m	2.50
1200107	20 m	3.50



	←-----→	kg
7605061	18.25 m	14.96

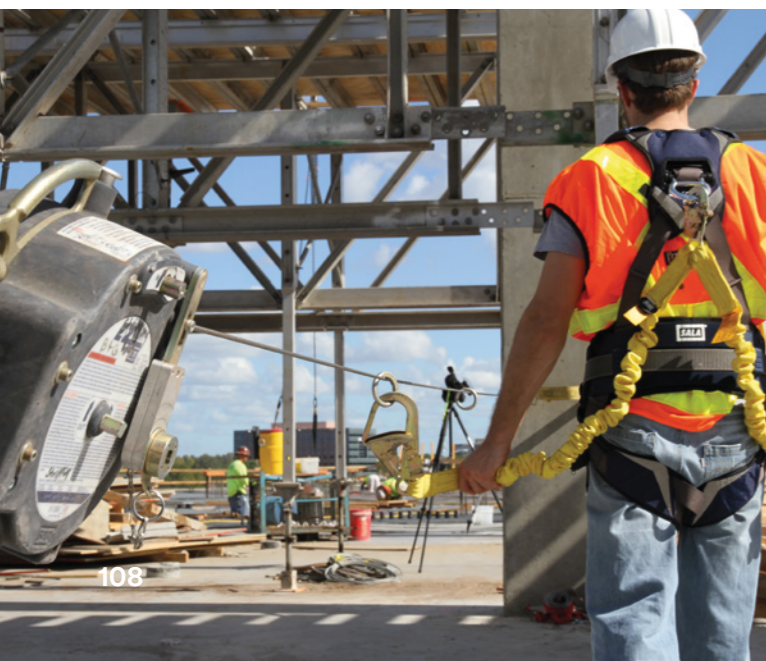

3M™ DBI-SALA®'s range of permanent Horizontal fall protection products has been developed to provide a choice of solutions that allow our customers to most effectively resolve the risks associated with working at height in a wide range of applications and comply with workplace safety regulations.

**3M™ DBI-SALA® RoofSafe™ Anchors**

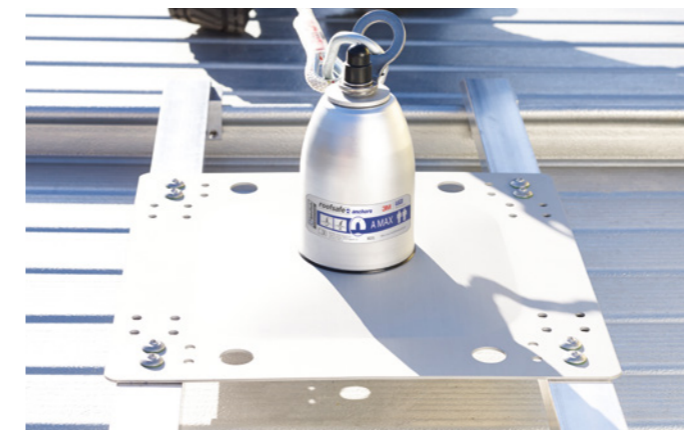

The RoofSafe Anchor from 3M™ Fall Protection has been designed to eliminate or substantially reduce the risk of injury or death to operatives working at height, whilst ensuring the integrity of the structure to which it is attached. The innovative 3M™ DBI-SALA® SpiralTech™ Energy Absorber results in the lowest forces back to the roof on the market measured at less than 6 kN.

**3M™ DBI-SALA® UniRail™**



UniRail is ideal for building projects, in particular for internal and external facade access, inspection and maintenance including walkways and suspended gantries. It is also extensively used for suspended access work by rope access technicians, as it meets the requirements of both abseil and fall protection standards.

**3M™ DBI-SALA® 8 mm Horizontal Lifeline System**



3M™ DBI-SALA® 8 mm Horizontal Lifeline System is ideally suited to modern building projects and refurbishments but can also be used for industrial safety applications. Minimal moving parts and high grade materials ensure long life expectancy, low cost of ownership and add up to a sound investment. Can be fitted to steel beams, concrete and brickwork and is suited for use on older roof constructions in conjunction with fabricated anchor points.

**3M™ DBI-SALA® 8 mm Overhead Horizontal Lifeline System**



3M™ DBI-SALA® 8 mm Overhead Horizontal Lifeline System was primarily developed to meet the needs of transport and industrial customers including lorries, trains and aircraft, crane walkways and loading bays. The system has also solved access and safety problems in the entertainment and arena industry. This quality safety solution can support heavy fall arrest and controlled rate descent devices, and ensures free and unhindered movement for the worker when carrying out work at height.

# 3M™ DBI-SALA® Lad-Saf™ Flexible Cable Vertical Safety Systems

## Working Safely at Height

Every day, workers around the world climb ladders to great heights to get their job done. Working at heights creates danger, and a need for maximum security. A fall can happen at any time and on any structure, during the climb to the top or on the way down.

## The Solution

The Lad-Saf permanently installed vertical safety system that offers complete fall protection for the worker. It is designed to work with many different styles and lengths of ladders on structures like wind turbines, communication towers, buildings, water towers and more.

The Lad-Saf flexible cable system consists of a top and bottom bracket that act as anchors for a steel cable that runs the length of the climbing area. The Lad-Saf Traveller connects the worker to the system, automatically follows the user during the climb and locks onto the cable in the event of a fall, allowing the user to regain their footing.

Designed for ease of use, economy and versatility, optional brackets/designs are available for bolting or welding the system, choose rung clamp sizes/styles, choose systems for connection to wood, concrete or steel structures. Hundreds of different brackets, styles and configurations are available to suit almost any application.

In addition, the versatile system can be used by up to four workers simultaneously for added jobsite flexibility.

And now adding or upgrading your vertical safety systems just got easier. The new generation of Lad-Saf™ Systems are re-engineered to simplify and speed up the installation process. With up to 72% fewer loose components\* than some of our previous models, these lightweight systems are streamlined for easy installation and maintenance on a variety of structures - such as fixed ladders and telecommunication towers.

## Applications



## Features

- Lad-Saf Travellers automatically follows user for hands-free climbing and fall protection (Use Lad-Saf X2 traveller with 8 mm or 9.5 mm cable, use X3 Traveller with 9.5 mm cable)
- Accommodates up to 4 workers at one time\*
- Customisable to suit almost any application
- Extremely rugged and corrosion resistant steel construction, Galvanised or Stainless Steel options available
- Built-in energy absorber protects user and structure
- Built-in tension indicator assures proper installation

\*Depending on configuration of the system.

### 3M™ DBI-SALA® Lad-Saf™ X2 Traveller for 8 mm and 9.5 mm cable



	Description	kg
6160030	Zinc plated steel carabiner	1.50
6160047	Stainless steel carabiner	1.40

### 3M™ DBI-SALA® Lad-Saf™ X3 Traveller for 9.5 mm cable



	Description	kg
6160054	Zinc plated steel carabiner	1.13
6160057	Stainless steel snap hook	1.60



**Rung, 2 User (shown)**

Stainless Steel - 6116632

**Rung, 2 User**

Galvanized Steel - 6116631

**Rung, 4 User**

Galvanized Steel - 6116633

**Monopole, 4 User**

Galvanized Steel - 6116634

**Monopole, 4 User**

Stainless Steel - 6116638

**Climb Extension, 2 User**

Galvanized Steel - 6116636

### Convenient

Integrated fall arrested anchor point.

### Fast

Installation is easy with fewer loose parts and more robust cable tensioning and termination as compared to our previous systems.



### New Pre-Swaged Cable Termination

Durable, high-strength steel construction that allows for easy installation and maintenance-free longevity.

### Flexible

Mounting brackets can be used on a variety of fixed ladder styles that may consist of different rung spacings and shapes.

### Previous Generation Cable

### Ladder, Climb Extension and Grab Bar-Telescoping application fit the following rung types and spacing:

	<b>Rung Spacing</b>	200 - 310 mm (9" - 12.25")
	<b>Cylindrical Rung</b>	19 - 40 mm (0.75" - 1.6") diameter
	<b>Square Rung</b>	19 - 40 mm (0.75" - 1.6")
	<b>Diamond Rung</b>	19 - 40 mm (0.75" - 1.6") height
	<b>Angle Iron</b>	19 - 40 mm (0.75" - 1.6") leg height
	<b>Rectangular Rung</b>	19 - 40 mm (0.75" - 1.6") height, 19 - 48 mm (0.75" - 1.9") width

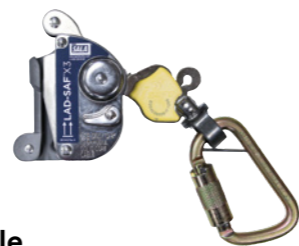

### Compatible

Designed for use with your Lad-Saf™ X3 Detachable Cable Sleeve (6160054 or 6160057). Also compatible with Lad-Saf X2 Detachable Cable Sleeve (6160030 and 6160047).

### Light

Total system weighs less than our previous 2 and 4 user systems.

### Simple

Most configurations use fewer than 13 separate components - up to 72% less than some of our previous models.

### Previous Generation System

### New Generation System

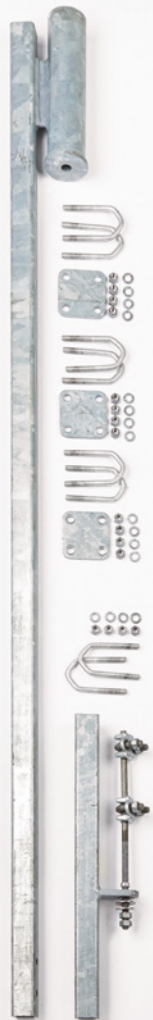

### Top & Bottom Bracket System (both brackets included)

	Application	User	Material
6116631	Rung	2 User	Galvanized Steel
6116632	Rung	2 User	Stainless Steel
6116633	Rung	4 User	Galvanized Steel
6116635	Wood Pole	2 User	Galvanized Steel
6116634	Monopole	4 User	Galvanized Steel
6116638	Monopole	4 User	Stainless Steel
6116636	Climb Extension	2 User	Galvanized Steel

### Pre-swaged cable at desired length

First 4 numbers in SKU represent the cable type, last 3 numbers represent cable length in metres.

	Diameter	Strand	Steel	Breaking strength
6134XXX	9.5 mm (3/8")	1 x 7	Galvanized	68.5 kN min
6135XXX	9.5 mm (3/8")	1 x 7	Stainless	68.5 kN min

### Lifeline cable offered in:

- 5 m to 10 m in 1 m increments
- 10 m to 50 m in 2 m increments
- 50 m to 100 m in 5 m increments



### Cable guides as needed (recommend every 6 - 12 m (20 - 40 ft.))

	Application(s)	Type	Material
6100400	Ladder	Straight Guide	Galvanized Steel
6100457	Ladder	Straight Guide	Stainless Steel
6100513	Ladder	L Guide	Stainless Steel
6100530	Ladder	Straight Guide	Galvanized Steel
6100401	Telescoping & Extension	Straight Guide	Stainless Steel
6100515	Monopole	L Guide	Galvanized Steel
6100140	Wood Pole	Straight Guide	Stainless Steel

### 3M™ DBI-SALA® Lad-Saf™ X3 Detachable Cable Sleeve

- Mobile design follows user for convenient climbing protection.
- Easy to install and detach anywhere along the cable lifeline.
- Dual independent locking system
- Choice of steel carabiner or stainless steel snap hook connector

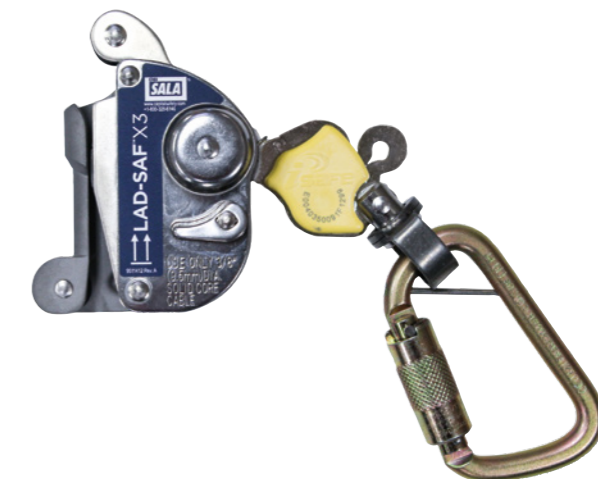

The 3M™ Protecta® Cabloc Vertical Cable System offers fall protection for workers whilst providing a functional and practical means of access and egress on structures such as wind turbines and communication towers.

It can be permanently installed to a ladder or other vertical structure. Components are available in either stainless or galvanised steel options.

## Features and benefits.

- ▶ Easy and quick to install
- ▶ The top and bottom anchors are available in either galvanised or stainless steel
- ▶ Bottom anchor tension indicator provides a visual indication that the cable is correctly tensioned
- ▶ Can be installed on structures that incline up to 15 degrees, making it suitable for a variety of structures
- ▶ Components are made from high-quality materials with corrosion-resistant finishes making the system suitable for installation in a wide range of aggressive environments
- ▶ Users can attach and detach at any point along the length of the system allowing easy access to platforms and adjacent work areas
- ▶ Traveller automatically follows the user and locks in the event of a fall, providing uninterrupted movement for the user during ascent and descent whilst maintaining complete safety
- ▶ The Cabloc system, used in conjunction with the new Cabloc traveller, is CE marked and tested and conforms with EN 353-1:2014. This provides the end user with complete confidence that the system meets the latest standards and legislation

## Applications.

3M™ Protecta® Cabloc™ Vertical Cable Safety Systems are suitable for use in a number of applications including:

- ▶ Ladder access
- ▶ Mast and pylon access including lattice construction towers and monopoles
- ▶ Wind turbine access
- ▶ Lighting column access



## Standard system.

For use on ladders.

### 3M™ Protecta® Cabloc™ Cable Vertical Safety System

#### Top Anchor (no shock absorber)

Galvanised steel – [6191035](#)  
 Stainless steel – [6191032](#)

#### 8mm Diameter Cable

Galvanised steel  
 (6 x 19) – [AC300GXX](#)  
 Stainless steel  
 (7 x 19) – [AC300SXX](#)

#### Traveller with Energy Absorber

Zinc-plated – [6180200](#)  
 Stainless steel – [6180201](#)

#### Intermediate Guide [AC320](#)

#### Bottom Anchor

Galvanised steel – [6191036](#)  
 Stainless steel – [6191033](#)

#### System ID Tag

EU – [6191088](#)  
 CEE – [6191104](#)  
 Arabic – [6191105](#)

○	Material type
⊗	Stainless steel
⊕	Galvanised steel

## Universal anchor option.

For use on ladders, monopoles and other structures. Refer to our technical data for more information.

### 3M Protecta Cabloc Cable Vertical Safety System with Universal Top and Bottom Anchors

#### Universal Top and Bottom Anchor

Stainless steel – [AC340](#)

#### Oval screw link connector

Stainless steel – [AJ502](#)

#### 8mm Diameter Cable

Galvanised steel  
 (6 x 19) – [AC300GXX](#)  
 Stainless steel  
 (7 x 19) – [AC300SXX](#)

#### Traveller with Energy Absorber

Zinc-plated – [6180200](#)  
 Stainless steel – [6180201](#)

#### Cable Tensioner

Stainless steel – [AC330](#)

#### Universal Top and Bottom Anchor

Stainless steel – [AC340](#)

#### System ID Tag

EU – [6191088](#)  
 CEE – [6191104](#)  
 Arabic – [6191105](#)

# One traveller, two options.

With its new integrated metal energy absorber, the 3M™ Protecta® Cabloc™ traveller is more robust than ever and comes with a captive carabiner in either galvanised steel or stainless steel.

## Capacity:

1 user up to 140kg (including tools).



## Upgrading your current 3M™ Protecta® Cabloc™ system just got easier...

The new 3M Protecta Cabloc traveller has been rigorously tested on all 3M Protecta Cabloc system configurations\* so upgrading your existing 3M Protecta Cabloc system to meet the latest standard is easy... just change to the new traveller!

Captive twist-lock carabiner (option of zinc-plated or stainless steel)



The anti-inversion feature on the traveller prevents the user from mounting the traveller on the cable incorrectly

An integrated energy absorber reduces the maximum fall arrest force. In the event of a fall this absorber also acts as a fall indicator, showing the device has been deployed and needs to be taken out of service



	Description	kg
6180200	3M Protecta Cabloc traveller with zinc-plated carabiner	0.72
6180201	3M Protecta Cabloc traveller with stainless steel carabiner	0.82

\* Using 8mm 6 x 19 galvanised cable and 8mm 7 x 19 stainless steel cable.

## Cable options.

Cable can be ordered by the metre, but may not be available for less popular lengths. In such cases, please order the next available length and cut to size on-site to achieve the desired length.



8mm, 6 x 19 Galvanised Steel Cable (Replace XX by the length required in m includes swage)

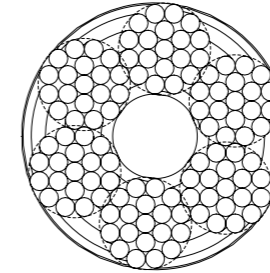

8mm, 7 x 19 Stainless Steel Cable (Replace XX by the length required in m includes swage)

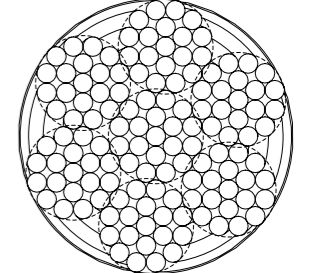

AC300GXX

AC300SXX

## 3M™ Protecta® Cabloc™ Cable Vertical Safety System Kit



	←→	Cable Guides	kg
6190101	10m	0	11.30
6190102	20m	1	14.60
6190103	30m	2	17.10
6190104	40m	3	20.10
6190105	50m	4	23.10



Kit includes all components needed: Traveller (6180200), universal top and bottom anchors (AC340 x 2), cable tensioner (AC330), oval screw link connector (AJ502), stainless steel cable (AC300SXX), cable guide quantity as indicated in table (AC320), system tag (6191088).



# The science of fighting gravity.

Protecting workers takes more than just keeping them from falling. Tools, objects and equipment dropped from height can be just as hazardous. From construction sites to oil rigs, we help make work environments safer and more productive by protecting workers from hazards that can result in personal injury, equipment damage and tool loss.

There are a number of important steps that must be included in any comprehensive dropped object prevention program. They include: identification of drop hazards, design of corrective measures, implementation of those measures, an inspection or audit program, selection and use of proper equipment and/or systems, and in-depth training programs.

## Applications



**3M**

**DBI  
SALA**

Fall Protection



# Everything you need to stop the drop.

Just like the ABCs of fall protection for workers, tools and objects require the proper anchorage, connector and attachment point (body support). The tool tether is only part of a complete Fall Protection for Tools 3-point system solution. You also need an attachment point and anchorage to ensure they're secure.

# Every industry is different. Every jobsite is different. Every worker is different.

That's why 3M™ DBI-SALA® Fall Protection for Tools offers a vast portfolio of anchorage, connector and attachment point solutions for a wide variety of industries and occupations. From carpenters to concrete finishers and iron workers to welders, we have the solutions that can help you.

## How to select a system:

There are many factors that go into choosing the system for any one worker's situation. This requires making specific determinations.

### How heavy is the tool or equipment?

- Weight will help determine what kind of tether (connector), attachment point and anchorage should be used.
- Use a scale or check the manufacturer's specs to determine the weight of the tool.

### A. What's the anchor point?

- The weight and use of the tool are critical factors in this decision.
- On the body vs. off the body (It's recommended that tools over 2.3 kg (5 lbs.) should never be anchored to the body).

### B. What are the attachment point options?

- Depending on the tool, there may be more than one option.
- Some manufacturers may have attachment points engineered into the design of the tool.
- The correct attachment point should not impact tool use.

### C. What's the appropriate connector for the tool?

- Usually there is more than one option—one size does not fit all.
- Connectors should not impact tool use.

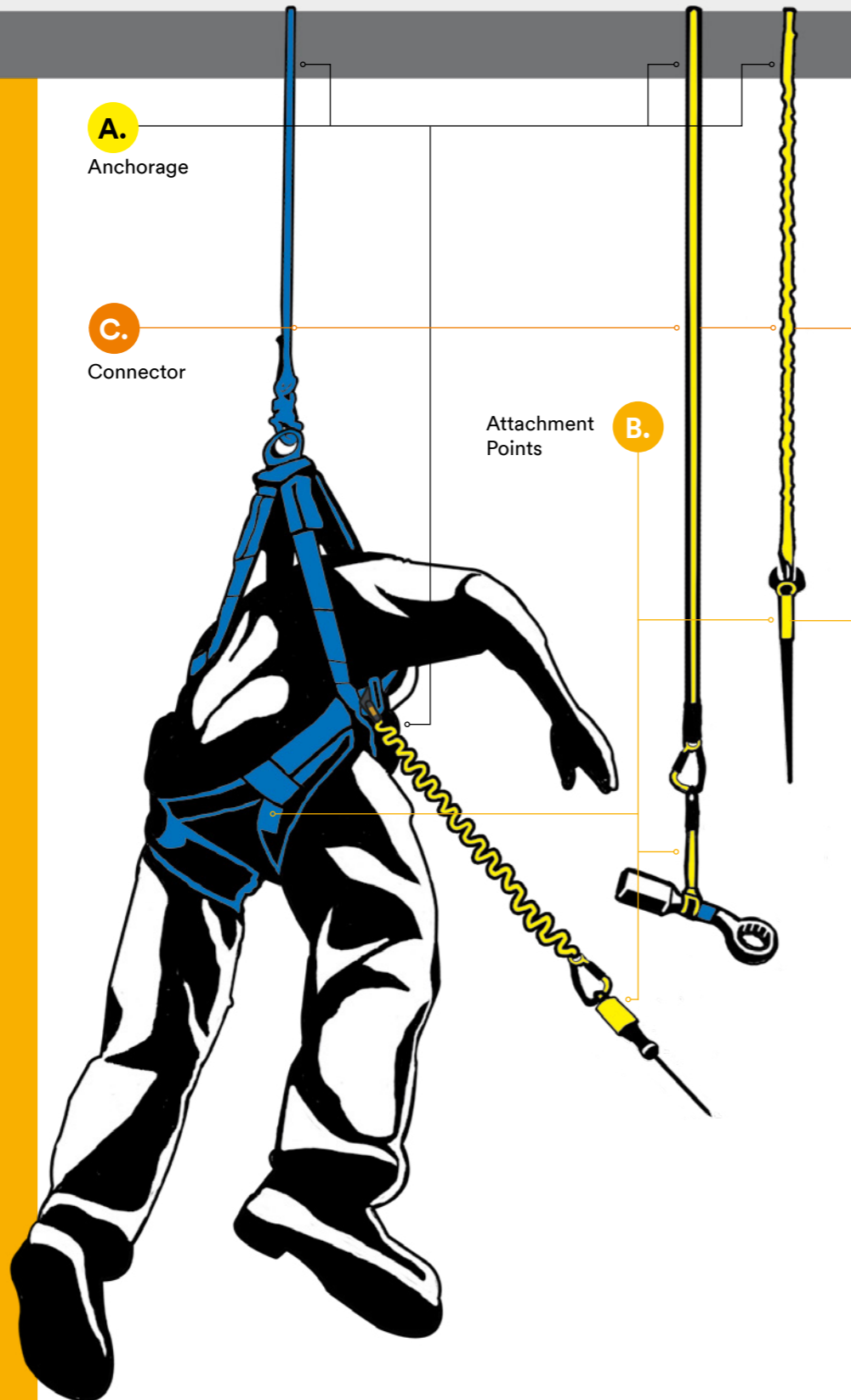

## Here's a sampling of some of our most popular products.

### B. Attachment Points



**1500174, 1500168, 1500171**  
Quick-Wrap Tape II.  
Load Rating:  
0.9 kg (2 lbs.)



**1500010**  
Micro D-Ring.  
Load Rating:  
0.9 kg (2 lbs.)  
(only when used  
with 1500060).



**1500027, 1500028, 1500029, 1500030**  
Quick Spin. Sm-XL.  
Load Rating:  
0.05 kg (1 lb.)



**1500024, 1500025, 1500026**  
Quick Ring.  
1.9cm to 3.8cm  
(0.75" to 1.5")  
Load Rating:  
0.9 kg (2 lbs.)

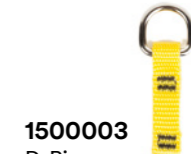

**1500003**  
D-Ring  
1.3 cm x 5.7 cm  
(0.5" x 2.25")  
Load Rating:  
0.9 kg (2 lbs.)

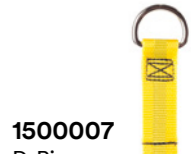

**1500007**  
D-Ring  
2.5 cm x 8.9 cm  
(1" x 3.5")  
Load Rating:  
2.7 kg (5 lbs.)



**1500009**  
D-Ring Cord.  
Load Rating:  
2.7 kg (5 lbs.)



**1500011**  
Tool Cinch MD.  
Load Rating:  
15.9 kg (35 lbs.)



**1500013**  
Tool Cinch MD  
Single Wing.  
Load Rating:  
15.9 kg (35 lbs.)



**1500015**  
Tool Cinch MD  
Dual Wing.  
Load Rating:  
15.9 kg (35 lbs.)



**1500017**  
Tool Cinch Heavy  
Duty.  
Load Rating:  
36.3 kg (80 lbs.)

### C. Tool Tethers



**1500156**  
2.3 kg (5 lbs.)  
Retractable Tool  
Lanyard with  
1500161 Harness  
Adapter.



**1500159, 1500160**  
Hook2Hook  
Coil Tether  
with Swivel.  
Qty. 1 or 10.  
Load Rating:  
2.3 kg (5 lbs.)



**1500178, 1500179**  
Hard Hat Tether.  
Qty. 10 or 100.  
Load Rating:  
1.8 kg (4 lbs.)



**1500047**  
Hook2Loop  
Bungee Tether.  
Load Rating:  
4.5 kg (15 lbs.)



**1500049**  
Medium-Duty  
Hook2Loop  
Bungee Tether.  
Load Rating:  
15.9 kg (35 lbs.)



**1500050**  
Medium-Duty  
Hook2Loop  
Lanyard.  
Load Rating:  
15.9 kg (35 lbs.)



**1500051**  
Heavy-Duty Hook2Loop Lanyard.  
Load Rating: 36.3 kg (80 lbs.)



**1500052**  
Heavy-Duty Hook2Rail Lanyard.  
Load Rating: 36.3 kg (80 lbs.)

To see the full range of Fall Protection for Tools, download the catalogue here.

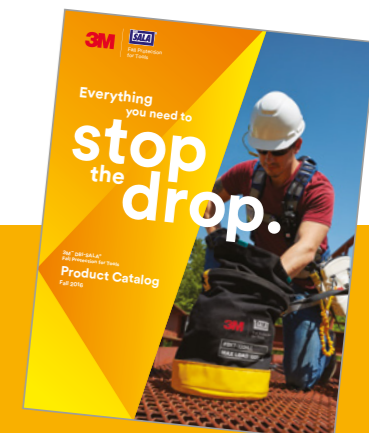

# Harness icons.



Chest



Leg



Waist



Pass Through Buckle



Quick Connect Buckle

# Lanyard icons.



Lanyard



Tie-Back



Loops with Thimbles



Carabiner



Screw Carabiner



Size of gate opening



Twist Lock



Edge Tested



Connector:  
Lanyard End



Connector:  
User End



Rope Type



Breaking Strength



Scaffold Hook



Snap Hook



Rebar Hook

# Self-Retracting Lifelines icons.



Housing



Retrieval Winch



RSQ



Leading Edge



Self Locking Swivel Hook



Lifeline Material



Edge Tested



Connector Material



Carabiner



Captive Eye



Rebar Hook



Scaffold Hook



Snap Hook

# General icons.



Dimension



Weight



Quantity



Diameter



Number of Users  
(Value)



Material Type



Coating Type



Webbing

Type:



Material:  
Aluminium



Material:  
Nylon



Material:  
Polyurethane



Material:  
Reflective



Material:  
Steel



Material:  
Stainless Steel



Material:  
Thermoplastic



Material:  
Vectran



Coating:  
Galvanised Steel



Coating:  
Sand Blasted



Coating:  
Zinc Plated

# Certification.

General:

**EN**  
1496

Rescue lifting  
devices

**CE**  
EN567

Rope clamps

**CE**  
2016/425

PPE Regulation

**CE**  
2006/42/EC

Machine Directive

Harnesses:

**CE**  
EN361

Full body  
harness

**CE**  
EN813

Sit  
harnesses

**EN**  
1497

Rescue  
harnesses

**CE**  
EN471

High-visibility  
warning clothing

Anchors:

**CE**  
EN353-1

Guided type  
fall arresters  
including a rigid  
anchor line

**CE**  
EN353-2

Guided type  
fall arresters  
including  
a flexible  
anchor line

**EN**  
795  
TYPE A

Anchors  
fixed to the  
structure

**CE**  
EN795  
TYPE B

Anchors not  
fixed to the  
structure

**EN**  
795  
TYPE C

Horizontal Lifeline  
with flexible  
support

**CE**  
EN795  
TYPE E

Counterweight  
anchor

Connectors:

**EN**  
341

Descender  
devices

**CE**  
EN354

Lanyards

**CE**  
EN355

Energy  
absorbers

**CE**  
EN358

Belts and restraint  
lanyards for work  
positioning

**CE**  
EN360

Retractable  
type fall  
arresters

**CE**  
EN362

Connectors

**3M Belgium BVBA / SPRL**

Hermeslaan 7  
1831 Diegem  
België / Belgique  
E-mail: [3Msafety.be@mmm.com](mailto:3Msafety.be@mmm.com)  
[www.3Msafety.be](http://www.3Msafety.be)

**3M Danmark**

Hannemanns Allé 53  
2300 København S  
Danmark  
E-mail: [3Msikkerhed@mmm.com](mailto:3Msikkerhed@mmm.com)  
[www.3Msikkerhed.dk](http://www.3Msikkerhed.dk)

**3M Deutschland GmbH**

Carl-Schurz-Straße 1  
D - 41453 Neuss  
Deutschland  
E-mail: [arbeitsschutz.de@mmm.com](mailto:arbeitsschutz.de@mmm.com)  
[www.3Marbeitsschutz.de](http://www.3Marbeitsschutz.de)

**3M Espana, S.A.**

Juan Ignacio Luca de Tena, 19-25  
28027 Madrid  
Espana  
E-mail: [ohes.es@3M.com](mailto:ohes.es@3M.com)  
[www.3M.com/es/seguridad](http://www.3M.com/es/seguridad)

**3M France**

Boulevard de l'Oise  
95006 Cergy Pontoise Cedex  
France  
[www.3M.com/fr/secure](http://www.3M.com/fr/secure)

**3M Greece**

20 Kifissias Ave.  
151 25 Maroussi  
Athens, Greece  
[www.3M.com/gr/occsafety](http://www.3M.com/gr/occsafety)

**3M Ireland Limited**

The Iveagh Building  
The Park, Carrickmines  
Dublin 18  
Ireland  
E-mail: [ohes.helpline.uk@mmm.com](mailto:ohes.helpline.uk@mmm.com)  
[www.3M.co.uk/safety](http://www.3M.co.uk/safety)

**3M Italia srl**

Via Norberto Bobbio, 21  
20096 Pioltello MI  
Italia  
E-mail: [3Msicurezza@mmm.com](mailto:3Msicurezza@mmm.com)  
[www.3Msicurezza.it](http://www.3Msicurezza.it)

**3M Nederland B.V.**

Molengraaffsingel 29  
2629 JD Delft  
Nederland  
E-mail: [3Msafety.nl@mmm.com](mailto:3Msafety.nl@mmm.com)  
[www.3Msafety.nl](http://www.3Msafety.nl)

**3M Norge A/S**

Postboks 100, 2026 Skjetten  
Norge  
E-mail: [kundeservice@mmm.com](mailto:kundeservice@mmm.com)  
[www.3M.no/vern](http://www.3M.no/vern)

**3M Österreich GmbH**

Kranichberggasse 4  
1120 Wien  
Österreich  
[www.3M.com/at/arbeitsschutz](http://www.3M.com/at/arbeitsschutz)

**3M Portugal**

Rua do Conde Redondo, 98  
1169-009 Lisboa  
Portugal  
[www.3M.com/pt/seguranca](http://www.3M.com/pt/seguranca)

**3M Suisse S.a r.l. / Schweiz GmbH**

Eggstrasse 93  
8803 Rüschiikon  
Suisse / Schweiz  
[www.3M.com/ch/safety](http://www.3M.com/ch/safety)

**Suomen 3M Oy**

Keilaranta 6  
02150 Espoo  
Suomi  
[www.3M.fi/suojaimet](http://www.3M.fi/suojaimet)

**3M Svenska AB**

191 89 Sollentuna  
Sverige  
E-mail: [kundeservice@mmm.com](mailto:kundeservice@mmm.com)  
[www.3M.se/personskydd](http://www.3M.se/personskydd)

**3M United Kingdom PLC**

3M Centre  
Cain Road  
Bracknell  
RG12 8HT  
United Kingdom  
E-mail: [ohes.helpline.uk@mmm.com](mailto:ohes.helpline.uk@mmm.com)  
[www.3M.co.uk/safety](http://www.3M.co.uk/safety)

## Important notice

**Product Selection and Use:** Many factors beyond 3M's control and uniquely within user's knowledge and control can affect the use and performance of a 3M product in a particular application. As a result, customer is solely responsible for evaluating the product and determining whether it is appropriate and suitable for customer's application, including conducting a workplace hazard assessment and reviewing all applicable national and/or European regulations and standards. Failure to properly evaluate, select, and use a 3M product in accordance with all applicable instructions and with appropriate safety equipment, or to meet all applicable safety regulations, may result in injury, sickness, death, and/or harm to property.

**Warranty, Limited Remedy, and Disclaimer:** A limitation of liability applies to the 3M product(s). For warranty statement and limitation of liability, refer to your supply agreement or the 3M terms & conditions of sale.

3M industrial and occupational products are intended, labeled, and packaged for sale to trained industrial and occupational customers for workplace use.

**3M Personal Safety Division****3M United Kingdom PLC**

3M Centre  
Cain Road  
Bracknell  
RG12 8HT  
United Kingdom  
t: 0870 60 800 60  
[www.3M.co.uk/ppesafety](http://www.3M.co.uk/ppesafety)

**3M Ireland Limited**

The Iveagh Building  
The Park, Carrickmines  
Dublin 18  
Ireland  
[www.3M.co.uk/ppesafety](http://www.3M.co.uk/ppesafety)

3M, DBI-SALA, EZ-Stop, Protecta, Sealed-Blok, RSQ, FAST-Line, First-Man-Up, Ultra-Lok, Nomex, RollGloss, FlexiGuard, EZ-Line, RoofSafe, UniRail, Lad-Saf, Pro, Sanchoc, Viper, Cobra, PRO-Line, Cabloc, Tech-Lite, Self-Lok, Repel, ExoFit NEX, Delta, EZ-Link, Spiral Tech, Safety-Walk and Trilomatic are trademarks of 3M Company.

Registered address: 3M Centre, Cain Road, Bracknell, Berkshire, RG12 8HT. Registered in England and Wales No. 1918922.

