



Specification Features

- FLEX SHOWER DOOR, SHOWER BASE & BACKWALLS
- SEMI-FRAMELESS DESIGN
- UP TO 1/2 IN. ADJUSTMENT PER SIDE FOR WIDTH/OUT-OF-PLUMB
- REVERSIBLE FOR RIGHT OR LEFT DOOR INSTALLATION
- UP TO 4 IN. WIDTH ADJUSTMENT WITHIN RAILS
- 1/4 IN. (6 MM) THICK CERTIFIED TEMPERED GLASS
- FULL LENGTH MAGNETIC LATCH FOR WATER TIGHT CLOSURE
- SOLID BRASS PIVOTS PROVIDE DURABILITY AND LUXURY
- LOW PROFILE THRESHOLD BASE DESIGN FOR EASY ENTRY
- SLIP-RESISTANT TEXTURED FLOOR PATTERN

Technical Information

- Model: Flex
- Door Type: Pivot
- Kit Dimensions: 60"W x 34"D x 76 3/4"H
- Access Width: 23"
- Glass Thickness: 1/4" [6 mm]
- Glass Type: Clear
- Base Type: Single Threshold
- Base Color: White

Codes/Standards Applicable

- ANSI Z97.1 (Tempered Glass)
- 16 CFR Part 1201
- cUPC

Hardware Finish Options:

- 01 - Chrome
- 04 - Brushed Nickel

Model SKU#s:

- DL-6229C-01 Center Drain Base Kit
- DL-6229L-01 Left Drain Base Kit
- DL-6229R-01 Right Drain Base Kit
- DL-6229C-04 Center Drain Base Kit
- DL-6229L-04 Left Drain Base Kit
- DL-6229R-04 Right Drain Base Kit

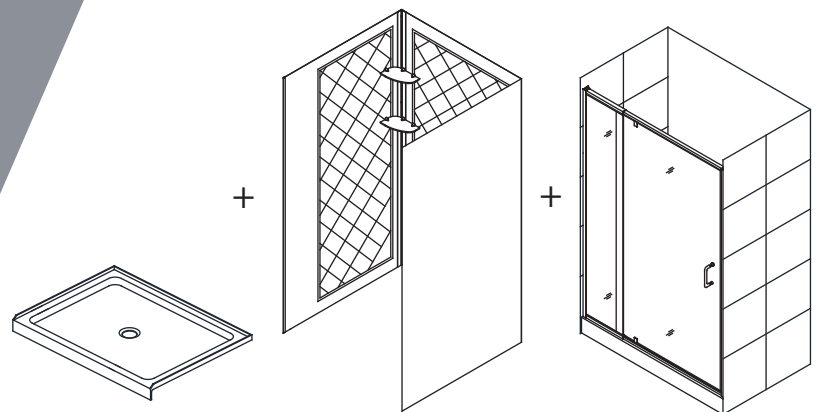

Available Product Configurations:

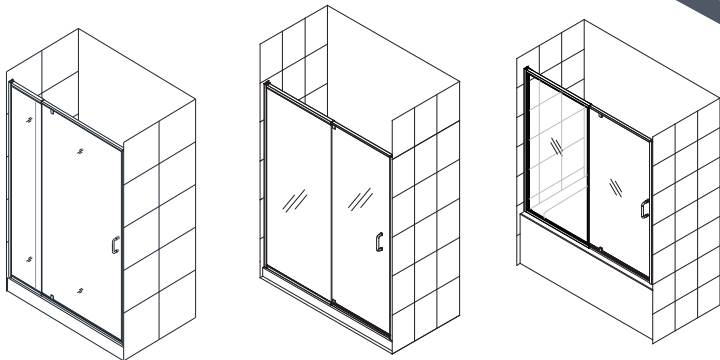

Shower Door SKU#s:

SHDR-22287200-XX

SHDR-22327200-XX

Shower Door SKU#s:

SHDR-22427200-01

SHDR-2242720-04

SHDR-22487200-01

SHDR-2248720-04

SHDR22547200-01

SHDR22547200-04

SHDR-22607200-01

SHDR-2260720-04

Tub Door SKU#s:

SHDR22605800-01

SHDR22605800-04

Important Notes:

If this unit is going to be installed in a new construction, please, install all of the required plumbing and drainage before installing the shower. Use a competent and licensed plumber for all plumbing installation period.

Accommodates up to 4 in. for width adjustment and 1/2 in. for out-of-plumb walls.

Professional installation recommended.

DO NOT attach the handle to the door glass until instructed in the installation manual. DO NOT use the handle to lift the glass during installation. This may result in damage to the glass and/or serious injury.

Important Disclaimers:

- Prior to installation, please ensure that the installation surface is finished, level and solid and will be able to support the total weight of the unit. Also, make sure that the walls are plumb. Irregular installation, surface level or out of square conditions can result in serious problems for your installation.
- Please read Installation Manual thoroughly prior to installing this product.4
- Please note that you should consult your local building codes with questions on installation compliance standards. Building and plumbing codes may vary by location, and DreamLine® is not responsible for code compliance standards for your project and will not accept any returns.

The Flex shower enclosure is NOT suitable for commercial installation.