



UNIDOOR-LS

Specification Features

- HINGED SHOWER DOOR. FRAMELESS GLASS DESIGN
- CONFIGURATION: SWING (HINGED) SHOWER DOOR AND INLINE PANEL
- REVERSIBLE FOR A RIGHT OR LEFT DOOR OPENING
- SOLID BRASS SELF-CLOSING HINGES
- UP TO 1 IN. ADJUSTMENT FOR WIDTH OR OUT-OF-PLUMB
- 3/8 IN. (10 MM) THICK CERTIFIED CLEAR TEMPERED GLASS
- CLEARMAX WATER AND STAIN RESISTANT GLASS COATING

Technical Information

- Model: Unidoor-LS
- Product Type: Hinged Shower Door
- Dimensions: 42 - 43 in. W x 72 in. H
- Access Width Max: 23 in.
- Access Width Min: 23 in.
- Inline Panel Width: 18 in.
- Threshold Width Min: 1 1/2 in.
- Glass Thickness: 3/8 in. (10 mm)
- Glass Pattern: Clear
- Glass Coating: ClearMax

Codes/Standards Applicable

- ANSI Z97.1 (Tempered Glass)
- 16 CFR Part 1201

Hardware Finish Options:

- 01 - Chrome
- 04 - Brushed Nickel
- 06 - Oil Rubbed Bronze
- 09 - Matte Black

Model SKU#s:

- SHDR-2042723-01 SHDR-2042723-04
- SHDR-2042723-06 SHDR-2042723-09

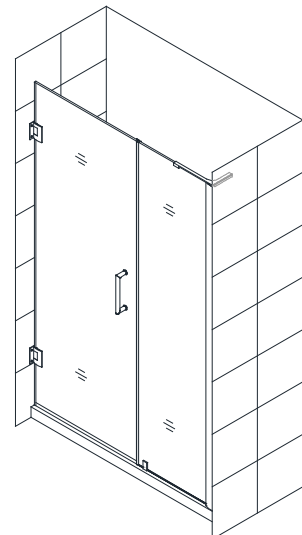

Unique Product Design Details:

Important Notes:



Solid Brass Self-Closing Hinge

DreamLine exclusive ClearMax water and stain resistant glass coating



Shower Door Handle

If this unit is going to be installed in a new construction, please, install all of the required plumbing and drainage before installing the shower. Use a competent and licensed plumber for all plumbing installation period.

Wall studs or other reinforcement behind finished walls required for hinge installation.

Inline panel attached to wall by anodized aluminum wall profile; Wall profile allows up to 1 in. adjustment for width or out-of-plumb (uneven walls).

Minimum threshold depth of 1 1/2 in. is required for proper installation.

Professional installation recommended.

IMPORTANT! All measurements should be taken only AFTER walls are finished (tile, back walls, etc.).

Important Disclaimers:

- Prior to installation, please ensure that the installation surface is finished, level and solid and will be able to support the total weight of the unit. Also, make sure that the walls are plumb. Irregular installation, surface level or out of square conditions can result in serious problems for your installation.
- Please read Installation Manual thoroughly prior to installing this product.
- Please note that you should consult your local building codes with questions on installation compliance standards. Building and plumbing codes may vary by location, and DreamLine® is not responsible for code compliance standards for your project and will not accept any returns.

For commercial customers, we strongly recommend the use of Dreamline's Onsite Contractor Support option.

Dreamline's commercial warranty does not apply to damage or losses resulting from (i) other than normal and proper use and normal service conditions; (ii) improper installation, (iii) installation in or upon an unsuitable surface or areas; (iv) abuse, (v) accident, (vi) alteration, (vii) misuse, (viii) neglect, (ix) unauthorized repair or the failure to utilize suitably qualified and trained persons to perform service and/or repair of the Product, (x) improper maintenance, (xi) failure to follow installation, operating, cleaning or maintenance instructions, and (xii) use of "non-authorized" parts.