

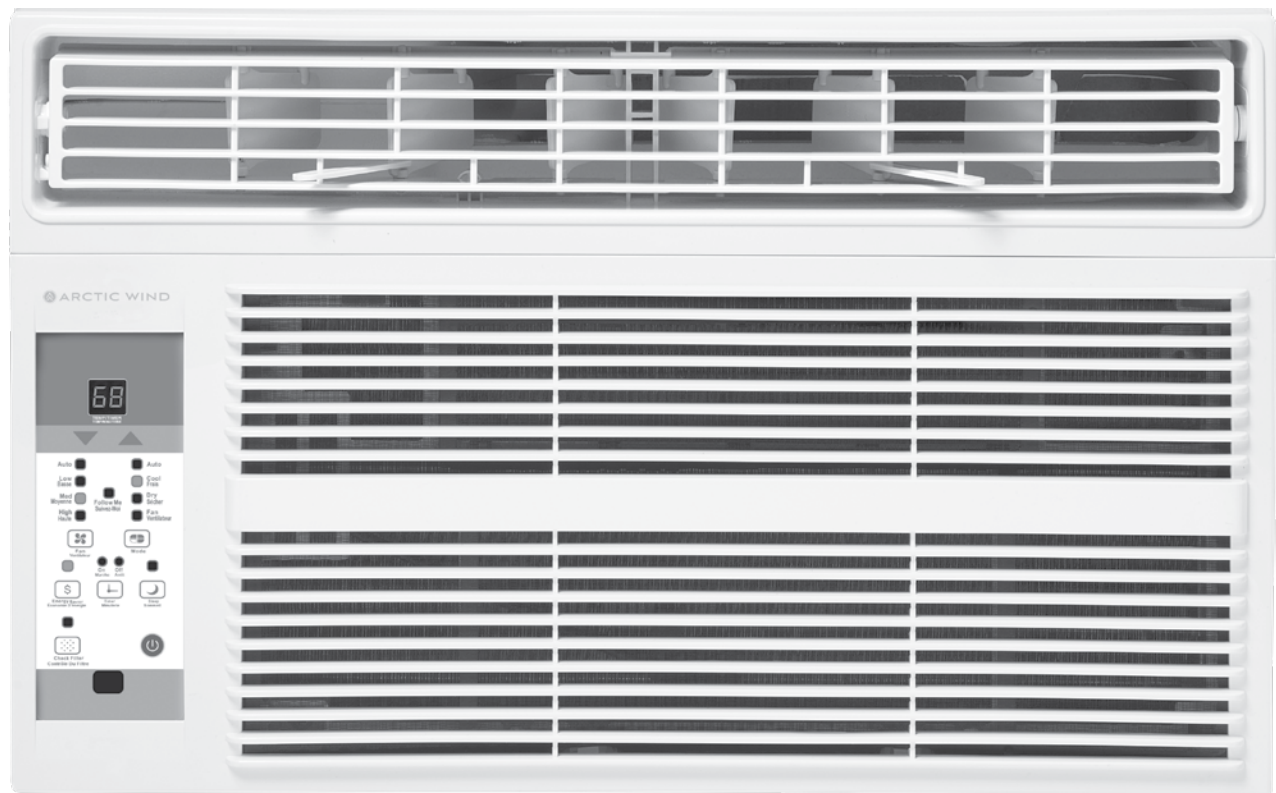

OWNER'S MANUAL

WINDOW AIR CONDITIONER



MODELS 3AW8000A, 4AW10000A, 4AW12000A

TABLE OF CONTENTS

IMPORTANT SAFETY INSTRUCTION	4
INSTALLATION INSTRUCTIONS	13
WHAT IS IN THE PACKAGE.....	13
WINDOW REQUIREMENTS	14
INSTALLATION OVERVIEW	14
IF AC IS BLOCKED BY A STORM WINDOW	18
REMOVING AC FROM WINDOW.....	19
NORMAL SOUNDS.....	19
OPERATION INSTRUCTIONS.....	20
GET TO KNOW THE FEATURES.....	20
ADJUST YOUR AC DIRECTION.....	23
CARE & MAINTENANCE.....	24
TROUBLESHOOTING.....	26



IMPORTANT NOTE:

Read the manual carefully. Make sure to save this manual for future reference. Illustrations in this manual are for explanatory purposes only, your actual product may look slightly different.

IMPORTANT SAFETY INSTRUCTION

















READ THESE SAFETY PRECAUTIONS BEFORE INSTALLATION AND OPERATION. For your safety, it is important that you read and follow the instructions in this manual to minimize the risk of personal injury, fire or electrical shock.

To prevent injury to the user or other people and property damage, the following instructions must be followed. Incorrect operation due to ignoring of instructions may cause harm or damage. The seriousness is classified by the following indications.

	WARNING	This symbol indicates that ignoring instructions may cause death or serious injury.
	CAUTION	This symbol indicates that ignoring instructions may cause moderate injury to your person, or damage to your unit or other property.

WARNING

OTHER SYMBOLS:  NEVER DO THIS.  ALWAYS DO THIS.

	Plug in power cord properly.	Failure to do so may cause electric shock or fire due to excess heat generation.
	DO NOT operate or stop the unit by inserting or pulling out the power plug directly from the wall.	Doing so may cause electric shock or fire due to heat generation.
	DO NOT use a damaged power cord.	Doing so may cause electric shock or fire. If the power cord is damaged, it must be replaced by the manufacturer or an authorized service center or a similarly qualified person in order to avoid a hazard.
	DO NOT modify power cord length or share the outlet with other appliances.	Doing so may cause electric shock or fire due to heat generation.
	DO NOT operate with wet hands or in damp environment.	Doing so may cause electric shock.
	DO NOT direct airflow directly at room occupants.	This could cause health issues.
	Always ensure effective grounding.	Incorrect grounding may cause electric shock.
	DO NOT allow water to run into electric parts.	Doing so may cause failure of machine or electric shock.
	Always install circuit breaker and a dedicated power circuit.	Incorrect installation may cause fire and electric shock.
	Always unplug the unit if strange sounds, smell or smoke comes from the unit.	Failure to do so may cause fire and electric shock.
	DO NOT use the socket if it is loose or damaged.	Doing so may cause fire and electric shock.
	DO NOT open the unit during operation.	Doing so may cause electric shock.
	DO NOT use firearms near unit.	Doing so may cause fire.
	DO NOT use the power cord close to heating appliances.	Doing so may cause fire and electric shock.
	DO NOT disassemble, modify, or drill holes into the air conditioner.	Doing so may cause failure and electric shock and void the manufacturer's warranty.
	Ventilate room before operating air conditioner if there is a gas leak from another appliance such as a stove.	Failure to do so may cause explosion, fire and burns.
	DO NOT use the power cord near flammable gas or combustibles, such as gasoline, benzene, thinner, etc.	Doing so may cause an explosion or fire.

IMPORTANT SAFETY INSTRUCTION

CAUTION

⊘	When removing air filter, DO NOT touch metal parts of the unit.	Doing so may cause an injury.
⊘	DO NOT clean with water.	Water may enter the unit and degrade the insulation causing an electric shock.
✓	Ensure proper ventilation, especially in rooms with a stove or other appliances.	Failure to do so may result in an oxygen shortage.
✓	Unit and circuit breaker/fuse must be switched OFF when cleaning.	Cleaning unit when power is ON may cause fire and electric shock and may cause an injury.
⊘	DO NOT put a pet or house plant where it will be exposed to direct air flow.	This could injure the pet or plant.
✓	Use ONLY as intended.	This unit is NOT intended to preserve precision devices, food, pets, plants, and art objects. It may cause deterioration of quality, etc.
✓	Stop operation and close the window in severe storms or hurricanes.	Operation with windows open may cause moisture to enter the room.
✓	Hold the plug by the head of the power plug when taking it out.	Failure to do so may cause electric shock and damage.
✓	If unit will not be used for a long period of time, unplug or turn OFF main power switch.	Leaving power on may cause unit failure or fire.
⊘	DO NOT place obstacles around air-inlets or inside of air-outlet.	Obstacles may cause appliance failure or accident.
✓	Periodically check installation bracket for damage.	Prolonged exposure to outdoor elements may cause damage to installation bracket, causing unit to fall.
✓	Always insert filter(s) securely. Clean filter(s) AT LEAST once every two weeks.	Operation without secured, installed filters may cause failure. A dirty filter can cause the unit to not run efficiently.
✓	Use only a soft cloth to clean the unit.	Cleaners or detergents may change the color or scratch the surface of the unit.
✓	Use caution when unpacking and installing.	Sharp edges could cause injury.
⊘	NEVER drink water drained from air conditioner.	Water from unit contains contaminants and could cause illness.
⊘	DO NOT place heavy objects on the power cord and always ensure that the cord is not compressed.	There is danger of fire or electric shock.
✓	If water enters the unit's electrical components, turn the unit off at the power outlet and switch off the circuit breaker. Isolate supply by taking the power-plug out and contact a qualified serviced technician.	There is danger of electric shock.

NOTE

This air conditioner is designed to be operated under the following conditions:

Cooling operation	Outdoor temp:	64-109°F/18-43°C (64-125° F/18-52°C for special tropical models)
	Indoor temp:	62-90° F/ 17-32°C

Performance may be reduced outside of these operating temperatures

OPERATION OF CURRENT DEVICE

The power supply cord contains a current device that senses damage to the power cord. To test your power supply cord do the following:

- Plug in the Air Conditioner.
- The power supply cord will have TWO buttons on the plug head. Press the TEST button, you will notice a click as the RESET button pops out.
- Press the RESET button again, you will notice a click as the button engages.
- The power supply cord is now supplying electricity to the unit. (On some products this is also indicated by a light on the plug head).

NOTE

- The power supply cord with this air conditioner contains a current detection device designed to reduce the risk of fire. In the event that the power cord is damaged, it cannot be repaired – it must be replaced with a cord from the product manufacturer.
- Do not use this device to turn the unit on or off.
- Always make sure the RESET button is pushed in for correct operation.
- The power supply cord must be replaced if it fails to reset when either the TEST button is pushed or if it cannot be reset.
- A new one can be obtained from the product manufacturer.
- If power supply cord is damaged, it cannot be repaired. It **MUST** be replaced by one obtained from the product manufacturer.

Grounding type wall receptacle

Power supply cord with 3-prong grounding plug and current detection device.

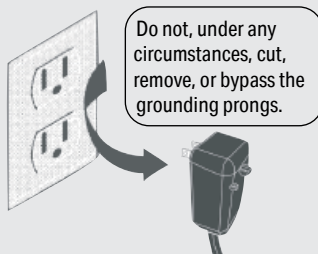

WARNING

ELECTRICAL INFORMATION

The complete electrical rating of your new room air conditioner is stated on the serial plate. Refer to the rating when checking the electrical requirements.

- Be sure the air conditioner is properly grounded. To minimize shock and fire hazards, proper grounding is important. The power cord is equipped with a three-prong grounding plug for protection against shock hazards.
- Your air conditioner must be used in a properly grounded wall receptacle. If the wall receptacle you intend to use is not adequately grounded or protected by a time delay fuse or circuit breaker, have a qualified electrician install the proper receptacle.
- Ensure the receptacle is accessible after the unit installation.
- Do not run air conditioner without side protective cover in place. This could result in mechanical damage within the air conditioner.
- Do not use an extension cord or an adapter plug.

Avoid fire hazard or electric shock. Do not use an extension cord or an adapter plug. Do not remove any prongs from the power cord.

FOR YOUR SAFETY

Do not store or use gasoline or other flammable vapors and liquids in the vicinity of this or any other appliance.

PREVENT ACCIDENTS

To reduce the risk of fire, electrical shock, or injury to persons when using your air conditioner, follow basic precautions, including the following:

- Be sure the electrical service is adequate for the model you have chosen. This information can be found on the serial plate, which is located on the side of the cabinet and behind the grille.
- If the air conditioner is to be installed in a window, you will probably want to clean both sides of the glass first. If the window is a triple track type and has a screen panel included, remove the screen completely before installation.

- Be sure the air conditioner has been securely and correctly installed according to the installation instructions in this manual.
- Save this manual for possible future use in removing or installing this unit.
- When handling the air conditioner, be careful to avoid cuts from sharp metal fins on front and rear coils.

ELECTRONIC WORK

WARNING

BEFORE PERFORMING ANY ELECTRICAL OR WIRING WORK, TURN OFF THE MAIN POWER TO THE SYSTEM

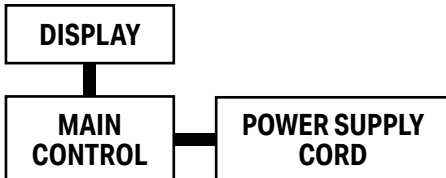

NOTE: The cognographs are for explanation purpose only. Your machine may be slightly different. The actual shape shall prevail.

WARNING

For using R32 refrigerant



- Do not use means to accelerate the defrosting process or to clean, other than those recommended by the manufacturer.
- The appliance shall be stored in a room without continuously operating ignition sources (for example: open flames, an operating gas appliance or an operating electric heater).
- Do not pierce or burn.
- Be aware that the refrigerants may not contain an odor.
- Appliance should be installed, operated and stored in a room with a floor area according to the amount of refrigerant to be charged. For specific information on the type of gas and the amount, please refer to the relevant label on the unit itself. When there are differences between the label and the manual on the Min. room area description, the description on label shall prevail.
- Appliance shall be installed, operated and stored in a room with a floor area larger than 43 sq. ft. (4 m²). Appliance shall not be installed in an unventilated space, if that space is smaller than 43 sq. ft. (4 m²).
- No open fire or device like switch which may generate spark/arcing shall be around appliance to avoid causing ignition of the flammable refrigerant used. Please follow the instructions carefully when storing or maintaining the appliance to prevent mechanical damage from occurring.
- Servicing should only be performed as recommended by the equipment manufacturer. Maintenance and repair requiring the assistance of other skilled personnel shall be carried out under the supervision of the person competent in the use of flammable refrigerants.
- DO NOT modify the length of the power cord or use an extension cord to power the unit.
- DO NOT share a single outlet with other electrical appliances. Improper power supply can cause fire or electrical shock. When maintaining or disposing the appliance, the refrigerant shall be recovered properly, shall not discharge to air directly.
- Compliance with national gas regulations shall be observed.
- Keep ventilation openings clear of obstruction.
- The appliance shall be stored so as to prevent mechanical damage from occurring.
- A warning that the appliance shall be stored in a well-ventilated area where the room size corresponds to the room area as specified for operation.
- Any person who is involved with working on or breaking into a refrigerant circuit should hold a current valid certificate from an industry-accredited assessment authority, which authorizes their competence to handle refrigerants safely in accordance with an industry recognized assessment specification. All training shall follow the ANNEX HH requirements of UL 60335-2-40. Examples for such working procedures are:
 - breaking into the refrigerating circuit;
 - opening of sealed components;
 - opening of ventilated enclosures.



A2L

CAUTION:
Risk of fire
flammable materials

Explanation of symbols displayed on the unit

	CAUTION	This symbol shows that the operation manual should be read carefully.
	CAUTION	This symbol shows that a service professional should be handling this equipment with reference to the installation manual.
	CAUTION	This symbol shows that information is available such as the operation manual or installation manual.

WARNING

For using R32 refrigerant

TRANSPORT OF EQUIPMENT CONTAINING FLAMMABLE REFRIGERANTS

- See transport regulations.

MARKING OF EQUIPMENT USING SIGNS

- See local regulations.

DISPOSAL OF EQUIPMENT USING FLAMMABLE REFRIGERANTS

- See national regulations.

STORAGE OF EQUIPMENT/APPLIANCES

- The storage of equipment should be in accordance with the manufacturer's instructions.

STORAGE OF PACKED (UNSOLD) EQUIPMENT

- Storage package protection should be constructed such that mechanical damage to the equipment inside the package will not cause a leak of the refrigerant charge.
- The maximum number of pieces of equipment permitted to be stored together will be determined by local regulations.

INFORMATION ON SERVICING

1. **Checking the area:** Prior to beginning work on systems containing flammable refrigerants, safety checks are necessary to ensure that the risk of ignition is minimized. For repair to the refrigerating system, the following precautions shall be complied with prior to conducting work on the system.
2. **Work procedure:** Work shall be undertaken under a controlled procedure so as to minimize the risk of a flammable gas or vapor being present while the work is being performed.
3. **General work area:** All maintenance staff and others working in the local area shall be instructed on the nature of work being carried out. Work in confined spaces shall be avoided. The area around the workspace shall be sectioned off. Ensure that the conditions within the area have been made safe by control of flammable material.
4. **Checking for presence of refrigerant:** The area should be checked with an appropriate refrigerant detector prior to and during work, to ensure the technician is aware of potentially flammable atmospheres. Ensure that the leak detection equipment being used is suitable for use with flammable refrigerants, i.e. non-sparking, adequately sealed or intrinsically safe.
5. **Presence of a fire extinguisher:** If any hot work is to be conducted on the refrigeration equipment or any associated parts, appropriate fire extinguishing equipment

WARNING

For using R32 refrigerant

shall be available to hand. Have a dry powder or CO2 fire extinguisher adjacent to the charging area.

6. **No ignition sources:** No person carrying out work in relation to a refrigeration system which involves exposing any pipe work that contains or has contained flammable refrigerant shall use any sources of ignition in such a manner that it may lead to the risk of fire or explosion. All possible ignition sources, including cigarette smoking, should be kept sufficiently far away from the site of installation, repairing, removing and disposal, during which flammable refrigerant can possibly be released to the surrounding space. Prior to work taking place, the area around the equipment is to be surveyed to make sure that there are no flammable hazards or ignition risks. No Smoking signs shall be displayed.
7. **Ventilated area:** Ensure that the area is in the open or that it is adequately ventilated before breaking into the system or conducting any hot work. A degree of ventilation shall continue during the period that the work is carried out. The ventilation should safely disperse any released refrigerant and preferably expel it externally into the atmosphere.
8. **Checks to the refrigeration equipment:** Where electrical components are being changed, they shall be fit for the purpose and to the correct specification. At all times the manufacturer's maintenance and service guidelines shall be followed. If in doubt consult the manufacturer's technical department for assistance.

The following checks shall be applied to installations using flammable refrigerants:

- The charge size is in accordance with the room size within which the refrigerant containing parts are installed.
- The ventilation machinery and outlets are operating adequately and are not obstructed.
- If an indirect refrigerating circuit is being used, the secondary circuit shall be checked for the presence of refrigerant.

- Marking to the equipment continues to be visible and legible. Markings and signs that are illegible should be corrected.
 - Refrigeration pipe or components are installed in a position where they are unlikely to be exposed to any substance which may corrode refrigerant containing components, unless the components are constructed of materials which are inherently resistant to being corroded or are suitably protected against being so corroded.
9. **Checks to electrical devices:**
 - Repair and maintenance to electrical components should include initial safety checks and component inspection procedures. If a fault exists that could compromise safety, then no electrical supply shall be connected to the circuit until it is satisfactorily dealt with. If the fault cannot be corrected immediately but it is necessary to continue operation, an adequate temporary solution should be used. This should be reported to the owner of the equipment, so all parties are advised.
 - Initial safety checks should include:
 - That capacitors are discharged: this shall be done in a safe manner to avoid possibility of sparking.
 - That there no live electrical components and wiring are exposed while charging, recovering or purging the system.
 - That there is continuity of earth bonding.

SEALED ELECTRICAL COMPONENTS SHALL BE REPLACED

1. During repairs to sealed components, all electrical supplies shall be disconnected from the equipment being worked upon prior to any removal of sealed covers, etc. If it is absolutely necessary to have an electrical supply to equipment during servicing, then a permanently operating form of leak detection shall be located at the most critical point to warn of a potentially hazardous situation.
2. Particular attention shall be paid to the following to ensure that by working on electrical components, the casing is not altered in such a way that the level of protection is affected. This shall include

WARNING

For using R32 refrigerant

damage to cables, excessive number of connections, terminals not made to original specification, damage to seals, incorrect fitting of glands, etc. Ensure that apparatus is mounted securely.

- Ensure that seals or sealing materials have not degraded such that they no longer serve the purpose of preventing the ingress of flammable atmospheres. Replacement parts should be in accordance with the manufacturer's specifications.

NOTE: The use of silicon sealant may inhibit the effectiveness of some types of leak detection equipment. Intrinsically safe components do not have to be isolated prior to working on them.

INTRINSICALLY SAFE COMPONENTS MUST BE REPLACED

- Do not apply any permanent inductive or capacitance loads to the circuit without ensuring that this will not exceed the permissible voltage and current permitted for the equipment in use. Intrinsically safe components are the only types that can be worked on while live in the presence of a flammable atmosphere. The test apparatus shall be at the correct rating.
- Replace components only with parts specified by the manufacturer. Other parts may result in the ignition of refrigerant in the atmosphere from a leak.

CABLING

- Check that cabling will not be subject to wear, corrosion, excessive pressure, vibration, sharp edges or any other adverse environmental effects. The check shall also take into account the effects of aging or continual vibration from sources such as compressors or fans.

DETECTION OF FLAMMABLE REFRIGERANTS

- Under no circumstances, should potential sources of ignition be used in the searching for or detection of refrigerant leaks. A halide torch (or any other detector using a naked flame) should not be used.

- The following leak detection methods are deemed acceptable for systems containing flammable refrigerants. Electronic leak detectors shall be used to detect flammable refrigerants, but the sensitivity may not be adequate, or may need re-calibration. (Detection equipment should be calibrated in a refrigerant-free area.) Ensure that the detector is not a potential source of ignition and is suitable for the refrigerant used. Leak detection equipment should be set at a percentage of the LFL of the refrigerant and shall be calibrated to the refrigerant employed and the appropriate percentage of gas (25 % maximum) is confirmed.
- Leak detection fluids are suitable for use with most refrigerants but the use of detergents containing chlorine shall be avoided as the chlorine may react with the refrigerant and corrode the copper pipework.
- If a leak is suspected, all naked flames should be removed/ extinguished. If a leakage of refrigerant is found which requires brazing, all of the refrigerant should be recovered from the system, or isolated (by means of shut off valves) in a part of the system remote from the leak. Removal of refrigerant shall be according to Removal and evacuation..

REMOVAL AND EVACUATION

- When breaking into the refrigerant circuit to make repairs—or for any other purpose - conventional procedures shall be used. However, for flammable refrigerants it is important that best practice is followed since flammability is a consideration.
- The following procedure shall be adhered to:
 - Remove refrigerant
 - Safely remove refrigerant following local and national regulations;
 - Evacuate;
 - Purge the circuit with inert gas (optional for A2L);
 - Evacuate (optional for A2L);
 - continuously flush or purge with inert gas when using flame to open circuit; and
 - open the circuit.
- The refrigerant charge should be recovered into the correct recovery cylinders. if venting is not allowed by local and national codes. For

WARNING

For using R32 refrigerant

appliances containing flammable refrigerants, the system shall be purged with oxygen-free nitrogen flammable refrigerants. This process might compressed air or oxygen shall not be used for purging refrigerant systems.

- For appliances containing flammable refrigerants, refrigerants purging shall be achieved by breaking the vacuum in the system with oxygen-free nitrogen and continuing to fill until the working pressure is achieved, then venting to atmosphere, and finally pulling down to a vacuum (optional for A2L).
- This process shall be repeated until no refrigerant is within the system (optional for A2L). When the final oxygen-free nitrogen charge is used, the system shall be vented down to atmospheric pressure to enable work to take place. The outlet for the vacuum pump shall not be close to any potential ignition sources, and ventilation shall be available.

CHARGING PROCEDURES

- In addition to conventional charging procedures, the following requirements should be followed.
 - Ensure that contamination of different refrigerants does not occur when using charging equipment.
 - Hoses or lines should be as short as possible to minimize the amount of refrigerant contained in them.
 - Cylinders should be kept upright.
 - Ensure that the refrigeration system is earthed prior to charging the system with refrigerant.
 - Label the system when charging is complete (if not already).
 - Extreme care should be taken not to overfill the refrigeration system.
 - Prior to recharging the system, it should be pressure tested with OFN.
 - The system should be leak tested on completion of charging but prior to commissioning.
 - A follow up leak test should be carried out prior to leaving the site.

DECOMMISSIONING

- Before carrying out this procedure, it is essential that the technician is completely familiar with the equipment and all its detail. It is recommended good practice that all refrigerants are recovered safely. Prior to the task being carried out, an oil and refrigerant sample should be taken in case analysis is required prior to re-use of reclaimed refrigerant. It is essential that electrical power is available before the task is commenced.
- Become familiar with the equipment and its operation.
- Isolate the system electrically.
- Before attempting the procedure ensure that:
 - When breaking into the refrigerant circuit to make repairs or for any other purpose, conventional procedures should be used.
 - Mechanical handling equipment is available, if required, for handling refrigerant cylinders.
 - Personal protective equipment is available and being used correctly.
 - The recovery process is supervised at all times by a competent person.
 - Recovery equipment and cylinders conform to the appropriate standards.
- Pump down refrigerant system, if possible.
- If a vacuum is not possible, make a manifold so that refrigerant can be removed from various parts of the system.
- Make sure that cylinder is situated on the scales before recovery takes place.
- Start the recovery machine and operate in accordance with manufacturer's instructions.
- Do not overfill cylinders. (No more than 80 % volume liquid charge).
- Do not exceed the maximum working pressure of the cylinder, even temporarily.
- When the cylinders have been filled correctly and the process is completed, make sure that the cylinders and the equipment are removed from the site promptly and all isolation valves on the equipment are closed off.
- Recovered refrigerant should not be charged into another refrigeration system unless it has been cleaned and checked.

WARNING

For using R32 refrigerant

LABELLING

- Equipment should be labelled stating that it has been de-commissioned and emptied of refrigerant. The label should be dated and signed. Ensure that there are labels on the equipment stating the equipment contains flammable refrigerant.

RECOVERY

- When removing refrigerant from a system, either for servicing or decommissioning, it is recommended good practice that all refrigerants are removed safely.
- When transferring refrigerant into cylinders, ensure that only appropriate refrigerant recovery cylinders are employed. Ensure that the correct number of cylinders for holding the total system charge is available. All cylinders to be used are designated for the recovered refrigerant and labelled for that refrigerant (i.e. special cylinders for the recovery of refrigerant). Cylinders shall be complete with pressure relief valve and associated shut-off valves in good working order. Empty recovery cylinders are evacuated and, if possible, cooled before recovery occurs.
- The recovery equipment shall be in good working order with a set of instructions concerning the equipment that is at hand and shall be suitable for the recovery of flammable refrigerants. If in doubt, the manufacturer should be consulted. In addition, a set of calibrated weighing scales shall be available and in good working order.
- Hoses shall be complete with leak-free disconnect couplings and in good condition.

- The recovered refrigerant shall be processed according to local legislation in the correct recovery cylinder, and the relevant waste transfer note arranged. Do not mix refrigerants in recovery units and especially not in cylinders. If compressors or compressor oils are to be removed, ensure that they have been evacuated to an acceptable level to make certain that flammable refrigerant does not remain within the lubricant. The compressor body shall not be heated by an open flame or other ignition sources to accelerate this process. When oil is drained from a system, it shall be carried out safely.

IMPORTANT NOTICE:

WARRANTY VOID FOR IMPROPER INSTALLATION

Please note that the warranty for the window air conditioner will be void if it is installed in a wall sleeve through a wall opening that will block any air vents, or any other type of installation method not specified in this user manual.

To ensure proper functioning and to maintain the validity of the warranty, it is crucial to strictly adhere to the installation procedure outlined in this user manual. Failure to do so may lead to damage or malfunctioning of the unit.

For detailed instructions on the correct installation process, please refer to the 'Installation Instruction' section of this user manual. Following these guidelines will help guarantee optimal performance and protect your warranty coverage.

If you have any questions or require further assistance, please don't hesitate to contact our US based customer service team at 855-663-9463. We are here to help ensure your satisfaction and maximize the longevity of your window air conditioner.

INSTALLATION INSTRUCTIONS

WHAT IS IN THE PACKAGE

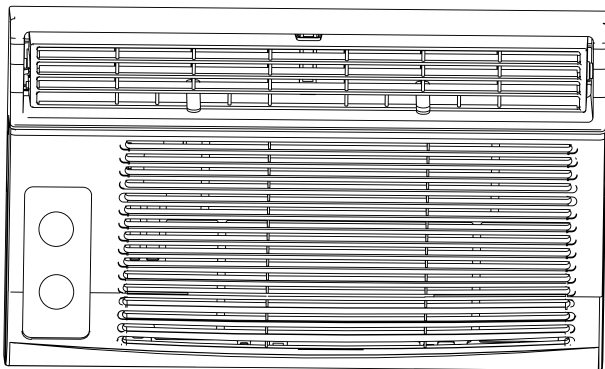

Window Type Room Air Conditioner unit

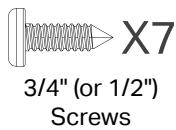

Sash Lock



Lock Frame



Window Sash Seal Foam

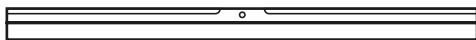

Top Rail

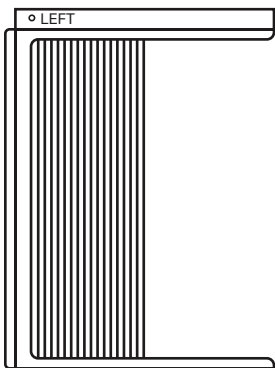

Frame Assembly (Left)

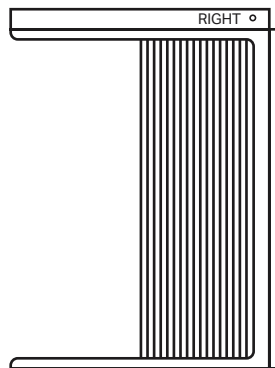

Frame Assembly (Right)

PREPARE THE FOLLOWING TOOLS



Gloves



Scissors

*Tools not included



Pencil

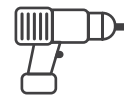

Drill



Screwdriver



Level

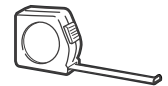

Ruler or tape measure

BEFORE THE INSTALLATION



The installation must be carried out in strict accordance with the instructions in this manual.

Do NOT install your air conditioner into a wall sleeve or enclosure of any type that interferes with any air vents.



Installing your AC should take about 60 minutes.



We recommend doing this with a helper.



We're here if you need us, please contact 855-663-9463 Mon-Fri for assistance.

NOTE: Illustrations in this manual are for explanatory purposes. The actual shape of your unit may be slightly different. The actual shape shall prevail.

WINDOW REQUIREMENTS

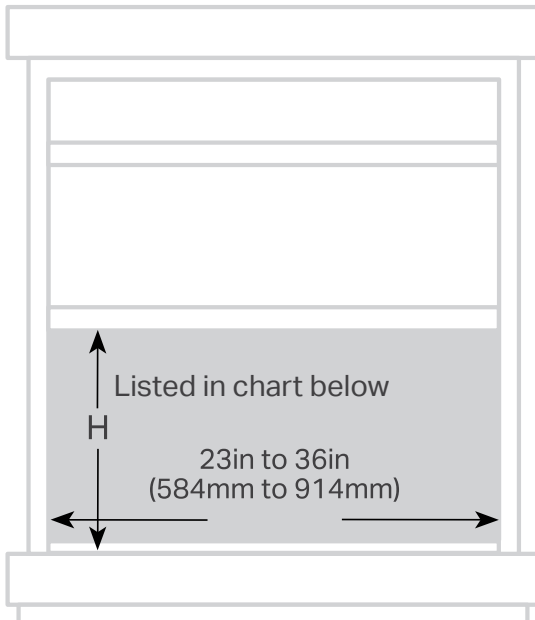

Your air conditioner is designed to install in standard double hung windows with opening widths of 23 to 36 inches (584mm to 914mm) and a minimum height in chart.

Window opening height	H
8000 Btu/h	14in (356mm)
10000~12000 Btu/h	15 - 1/2in (394mm)

⚠ CAUTION

- Do not, under any circumstances, cut or remove the third (ground) prong from the power cord.
- Do not change the plug on the power cord of the air conditioner. Aluminum house wiring may present special problems- consult a qualified electrician. When handling unit, be careful to avoid cuts from sharp metal edges and aluminum fins on front and rear coils.
- The rear of the unit must be outdoors, not inside a building or garage.

INSTALLATION OVERVIEW

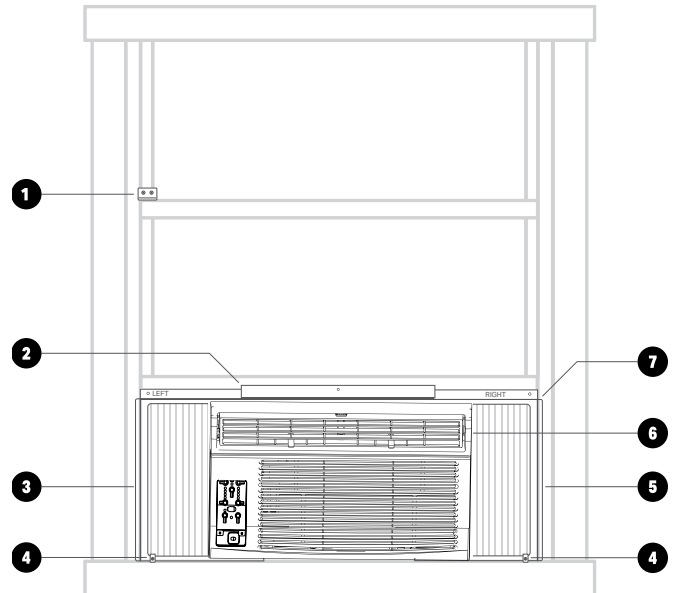

- 1 Sash Lock and 5/8in Screws
- 2 Top Rail and 3/8in Screws
- 3 Frame Assembly (Left)
- 4 Safety Lock and 5/8in Screw
- 5 Frame Assembly (Right)
- 6 Air Conditioner unit
- 7 Window Sash Seal Foam

IMPORTANT NOTICE:

WARRANTY VOID FOR IMPROPER INSTALLATION

Please note that the warranty for the window air conditioner will be void if it is installed in a wall sleeve or any other type of enclosure that interferes with any air vents. Failure of proper installation will lead to damage or malfunctioning of the unit.

For detailed instructions on the correct installation process, please refer to the 'Installation' section of this user manual. Following these guidelines will help guarantee optimal performance and protect your warranty coverage.

STEP 1 PREPARE THE WINDOW

Lower sash must open sufficiently to allow a clear vertical opening of 13 inches (330 mm). Side louvers and the rear of the AC must have clear air space to allow enough airflow through the condenser for heat removal. The rear of the unit must be outdoors, not inside a building or garage.

MOUNTING HARDWARE:

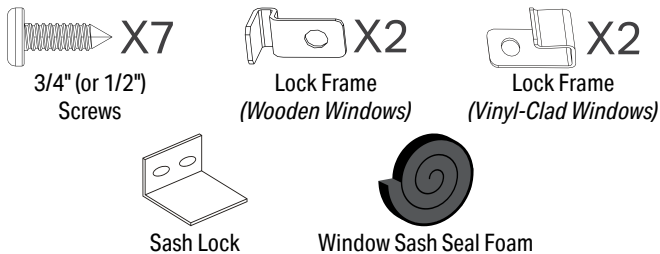

Window opening height	H
8000 Btu/h	14in (356mm)
10000~12000 Btu/h	15 - 1/2in (394mm)

STEP 2 PREPARE AIR CONDITIONER

- Remove the air conditioner from the carton and place on a flat surface.
- Remove the top rail from the packaging material as shown in Fig. A

TOP RAIL HARDWARE:

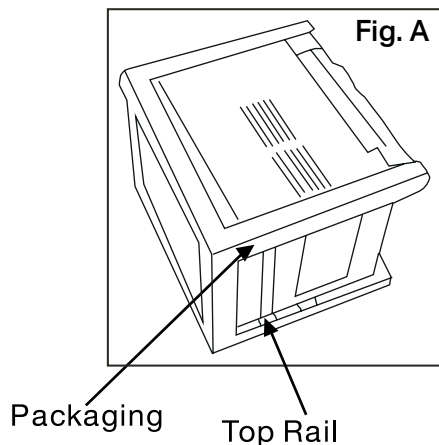

- Align the hole in the top rail with those in the top of the unit as shown in Fig. B.

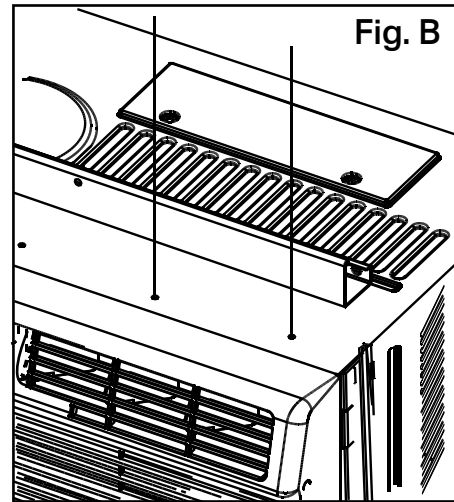

- Secure the top rail to the unit with the 3/8" screws as shown in Fig. C.

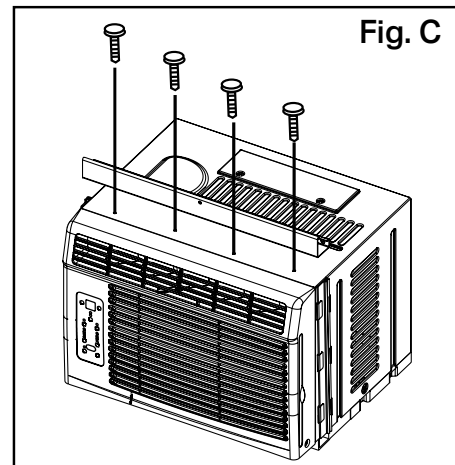

NOTE: For safety reasons, all four (4) screws MUST be securely fastened.

STEP 3 INSTALLING THE WINDOW AIR CONDITIONER

NOTE: Top rail and sliding panels on each side are offset to provide the proper pitch of $\frac{5}{16}$ " to the rear. This is necessary for proper condensed water utilization and drainage. If you are not using the side panels for any reason, this pitch to the rear must be maintained.

- A. Place unit on floor, a bench or a table. There is one left and one right side filler panel. Be sure to use the proper panel for each side. When installed, the flange for securing the panel to the window sill will be facing into the room.
- B. Hold the accordion panel in one hand and gently pull back the center to fill the open end. See Fig. 1.

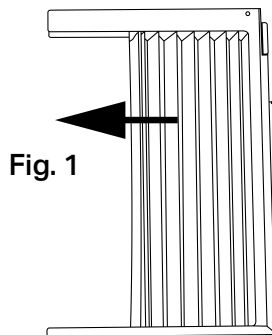

- C. Slide the free end "I" section of the panel directly into the cabinet as shown in Fig. 2. Slide the panel down. Be sure to leave enough space to slip the top and bottom of the frame into the rails on the cabinet.

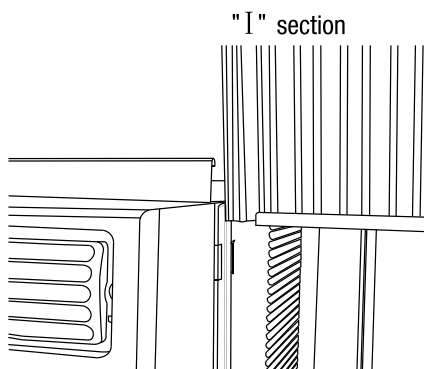

Fig. 2

- D. Once the panel has been installed on the

side of the cabinet, make sure it sits securely inside the frame channel by making slight adjustments. Slide the top and bottom ends of the frame into the top and bottom rails of the cabinet. Fig. 3.

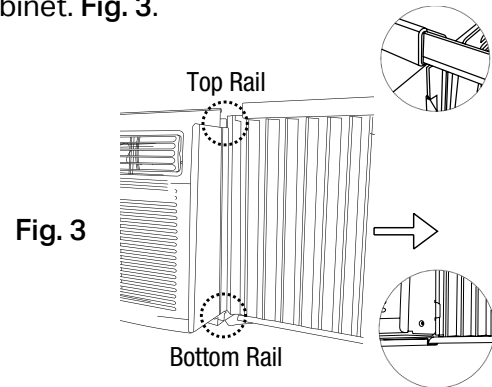
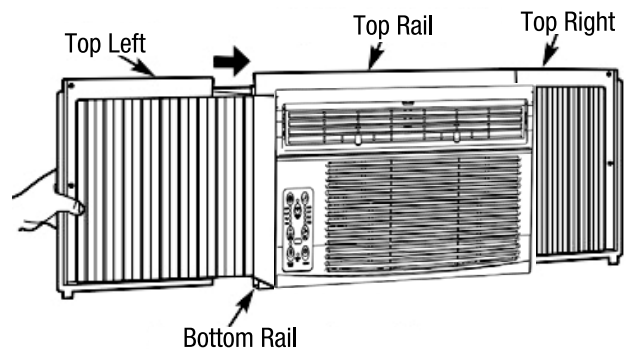

Fig. 3

- E. Slide the panel all the way in and repeat on the other side. Fig. 4."



NOTE: If storm window blocks AC, see Fig. 11, pg. 19.

STEP 4

SECURE THE ACCORDION PANELS

- A. Keeping a firm grip on the air conditioner, carefully place the unit into the window opening so the bottom of the air conditioner frame is against the window sill **Fig. 5**. Carefully close the window behind the top rail of the unit.

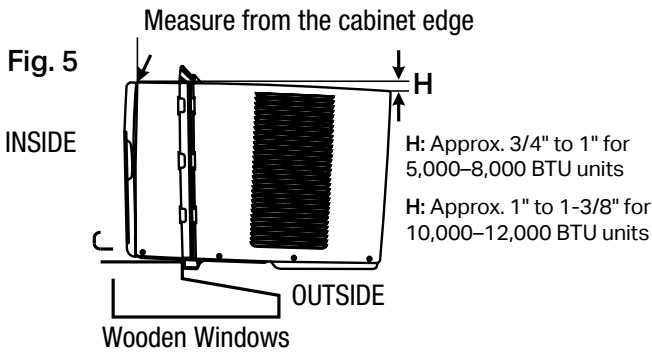

NOTE: Check that air conditioner is tilted back approximately $\frac{3}{4}$ " to $1\frac{3}{8}$ "

Fig. 5 (tilted about 3° to 4° downward to the outside). If, after proper installation, condensation does not drain from the overflow drain hole during normal use, adjust slope.

- B. Extend the side panels out against the window frame **Fig. 6**.

Fig. 6

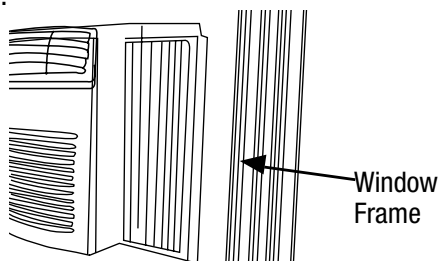

STEP 5

INSTALL SUPPORT BRACKET

- A. Place the frame lock between the frame extensions and the window sill as shown in **Fig. 7**. Drive $\frac{3}{4}$ " (19 mm) or $\frac{1}{2}$ " (12.7 mm) locking screws through the frame lock and into the sill.

NOTE: To prevent window sill from splitting, drill $\frac{1}{8}$ " (3 mm) pilot holes before driving screws.

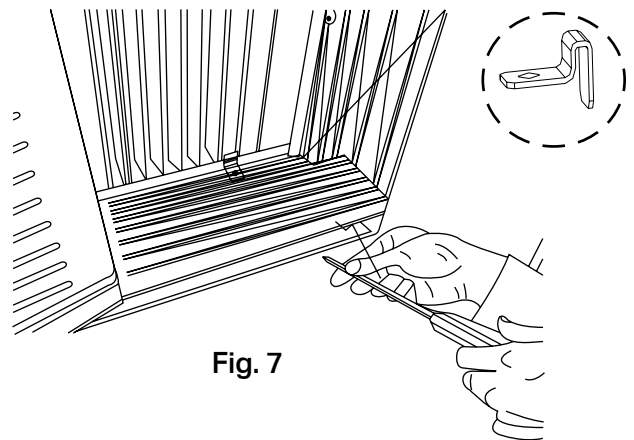

Fig. 7

- B. Drive $\frac{3}{4}$ " (19 mm) or $\frac{1}{2}$ " (12.7 mm) locking screws through frame holes into window sash **Fig. 8**.

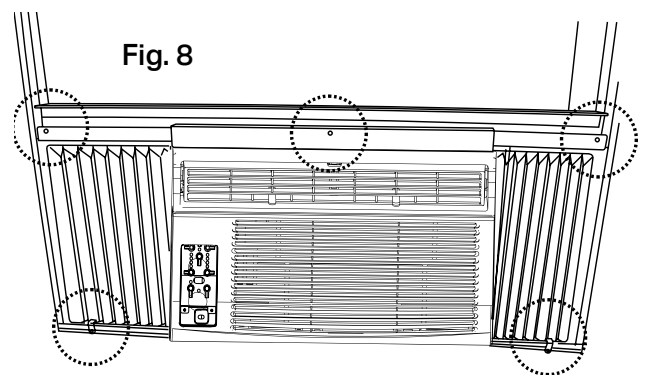

Fig. 8

- C. To secure lower sash in place, attach right angle

sash lock with 3/4" (19 mm) or 1/2" (12.7 mm) screw as shown Fig. 9.

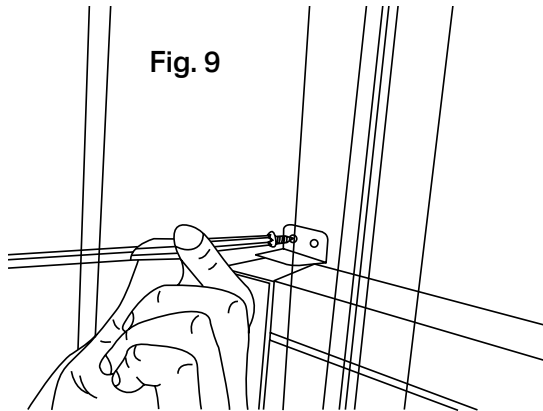

Fig. 9

D. Cut window sash seal foam and insert it in the space between the upper and lower sashes Fig. 10.

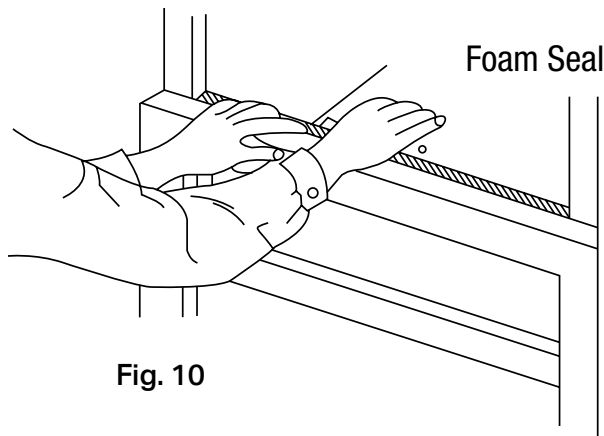

Fig. 10

IF AC IS BLOCKED BY A STORM WINDOW

Add wood as shown in Fig.11, or remove storm window before air conditioner is installed.

If storm window frame must remain, be sure the drain holes or slots are not caulked or painted shut. Accumulated rain water or condensation must be allowed to drain out.

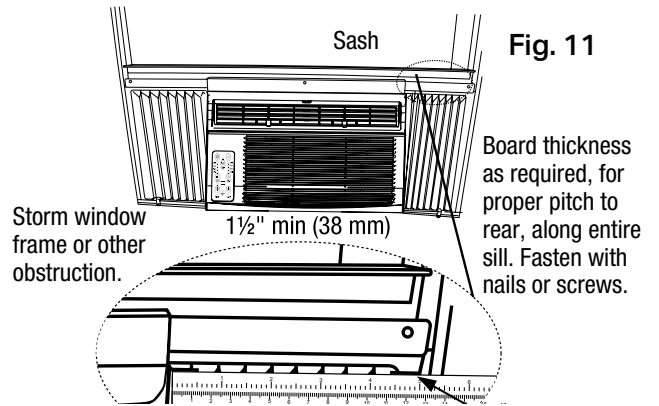
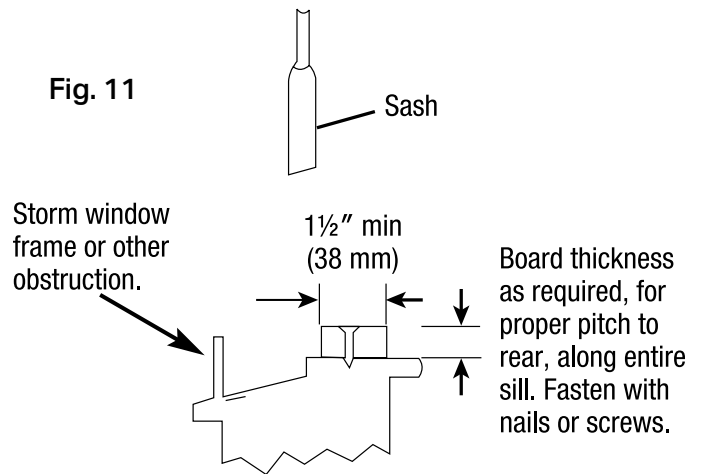

Fig. 11

Fig. 11



REMOVING AC FROM WINDOW

- Turn AC off, and disconnect power cord.
- Remove sash seal from between windows, and unscrew safety sash lock.
- Remove screws installed through frame and frame-lock.
- Close (slide) side accordion panels into frame.
- Keeping a firm grip on air conditioner, raise sash and carefully remove.
- Be careful not to spill any remaining water while lifting unit from window. Store parts WITH air conditioner.

NORMAL SOUNDS

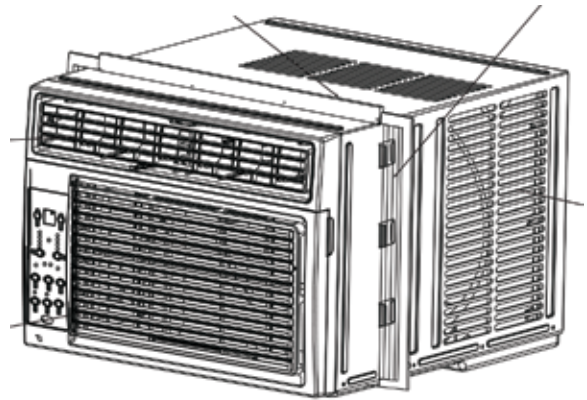

High Pitched Chatter

High efficiency compressors may have a high pitched chatter during the cooling cycle.

Sound of Rushing Air

At the front of the unit, you may hear the sound of rushing air being moved by the fan.

Gurgle/Hiss

"Gurgling or hissing" noise may be heard due to refrigerant passing through evaporator during normal operation.

Vibration

Unit may vibrate and make noise because of poor wall or window construction or incorrect installation.

Pinging or Switching

Droplets of water hitting condenser during normal operation may cause "pinging or swishing" sounds. This noise can be reduce by removing the water plug at the bottom of unit's rear as shown below. Removing this plug will lower the Energy Efficiency of your unit.

NOTE: Don't try to drill any holes on the base pan to eliminate the normal sounds, otherwise it will void the warranty. Internal parts can be permanently damaged by drilling a hole into the base pan or any other location on the machine. The machine is designed to evaporate the water under normal conditions, not continuously drain.

OPERATION INSTRUCTIONS

GET TO KNOW THE FEATURES

⚠ WARNING

- To reduce the risk of fire, electric shock, or injury to persons, read the IMPORTANT SAFETY INSTRUCTIONS before operating this appliance.
- Please always wait 3 minutes when turning unit off then on again, and when changing from cool to fan and back to cool. This prevents compressor from overheating & possible circuit breaker tripping.

ELECTRONIC CONTROL OPERATING INSTRUCTIONS

Thoroughly familiarize yourself with the control panel as shown below and all of its functions. Afterwards, follow the symbol for the functions you desire BEFORE operating the unit. This unit can be controlled by the unit control or with the remote control.

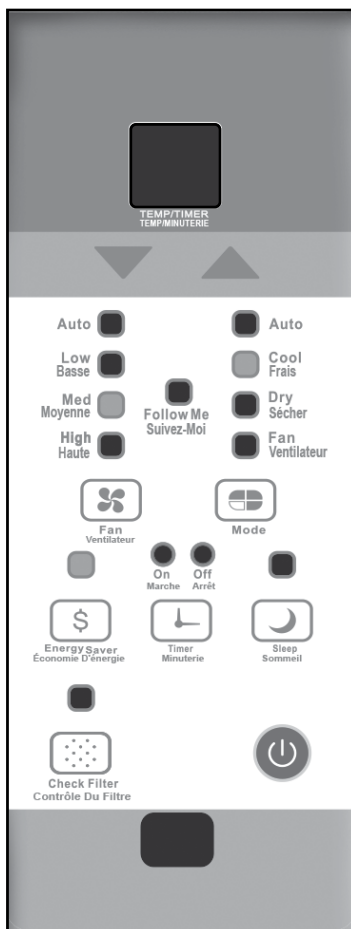



TO TURN UNIT ON OR OFF

Press  POWER button to turn unit on or off.

NOTE: The unit will initiate automatically the Energy Saver function under COOL, DRY and AUTO modes. (only AUTO-COOLING and AUTO-FAN modes).

TO CHANGE TEMPERATURE SETTING

Press  button to change temperature setting.

NOTE: Press or hold either UP or DOWN (or  symbols) button until the desired temperature is shown on the display. This temperature will be automatically maintained anywhere between 62°F (17°C) and 86°F (30°C). If you want the display to read the actual room temperature, set the machine to Fan Mode.

TO ADJUST FAN SPEEDS

Press  button to select the Fan Speed in four steps-Auto, Low, Med or High. Each time the button is pressed, the fan speed mode is shifted. During DRY mode the fan speed is set to Low and cannot be adjusted.

SLEEP FEATURE

Press  SLEEP button to initiate the SLEEP mode. In this mode the selected temperature will increase (cooling) or decrease (heating) by 2°F/1°C 30 minutes after the mode is selected. The temperature will then increase (cooling) or decrease (heating) by another 2°F/1°C after an additional 30 minutes. This new temperature will be maintained for 6 or 7 hours before it returns to the originally selected temperature. This ends the SLEEP mode and the unit will continue to operate as originally programmed. The SLEEP mode program can be cancelled at any time during operation by pressing the SLEEP button again.

CHECK FILTER FEATURE

Press  Check filter button to initiate this feature. This feature is a reminder to clean the Air Filter for more efficient operation. The LED (light) will illuminate after 250 hours of operation. To reset after cleaning the filter, press the button and the light will go off.

ENERGY SAVER/ECO FEATURE

Press  ENERGY SAVER button to initiate this function. This function is available on COOL, DRY, AUTO (only AUTO-COOLING and AUTO-FAN) modes. The fan will continue to run for 3 minutes after the compressor shuts off. The fan then cycles on for 2 minutes at 10 minute intervals until the room temperature is above the set temperature, at which time the compressor turns back on and Cooling starts.

FOLLOW ME FEATURE

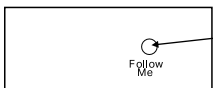

Light Flashing

This feature can be activated from the remote control ONLY. The remote control serves as a remote thermostat allowing for the precise temperature control at its location.

To activate the FOLLOW ME feature, point the remote control towards the unit and press the Follow Me button. The remote display is actual temperature at its location. The remote control will send this signal to the air conditioner every 3 minutes interval until press the Follow Me button again. If the unit does not receive the Follow Me signal during any 7 minutes interval, the unit will beep to indicate the Follow Me mode has ended.

TO SELECT THE OPERATING MODE

To choose operating mode, press the  Mode button. Each time you press the button, a mode is selected in a sequence that goes from AUTO, COOL, DRY, HEAT and FAN. The indicator light beside will be illuminated and remained on once the mode is selected.

The device activates the Energy Saver function automatically when operating in COOL, DRY, or AUTO mode, specifically under AUTO-COOLING and AUTO-FAN. You may turn it off by pressing the "Energy Saver" button on the control panel.

To operate on COOL mode

- Choose COOL Mode to set the cooling function. Use the ▲/▼ buttons to choose the desired temperature.
- When Cool Mode is selected, the fan speed can be adjusted by pressing the FAN button.

To operate on AUTO mode

- Auto Mode is designed to automatically regulate the room temperature around the temperature point set by you. This means that once you have set the desired temperature, the air conditioner will rotate between modes accordingly to maintain that temperature point.
- In this mode, the fan speed cannot be adjusted, it starts automatically at a speed according to the room temperature.

To operate on FAN ONLY mode

- Use this function  only when cooling is not desired, such as for room air circulation or to exhaust stale air. (Remember to open the vent during this function, but keep it closed during cooling for maximum cooling efficiency.)
- During Fan Mode:
 - You may chose any fan speed.
 - The display will show the actual room temperature.
 - The temperature will not be adjustable.

To operate on DRY mode

- In this mode, the air conditioner will generally operate in the form of a dehumidifier. Since the conditioned space is a closed or sealed area, some degree of cooling will occur.
- In Dry Mode, the fan speed is automatically set to Low and cannot be adjusted.

TIMER: AUTO START/STOP FEATURE

- Press  button, the TIMER ON or TIMER OFF indicator light illuminates. It indicates the Auto Start or Auto Stop program is initiated. For some units, keep pressing the Timer button will cancel the timer settings.
- Press or hold the UP or DOWN button to change the Auto time by 0.5 hour increments, up to 10 hours, then at 1 hour increments up to 24 hours. The control will count down the time remaining until start.
- The selected time will register in 5 seconds, and the system will automatically revert back to display the previous temperature setting or room temperature when the unit is on. (When the unit is off, there is no display.)
- Turning the unit ON or OFF at any time or adjusting the timer setting to 0.0 will cancel the Auto Start/Stop timed program.

NOTE: When you set the timer, the unit will only go on once and off once. If you want the air conditioner to cycle on and off based on desired room temperature, you do not need to set the timer. Instead, set your desired temperature and the unit will cycle on and off based on that temperature setting.

DISPLAY

Shows the set temperature in "°F" or "°C" and the Auto-timer settings. While on FAN only mode, it shows the room temperature.

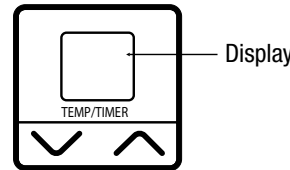

If the room temperature has more than two digits and cannot be displayed on the screen, it will display "HI" or "LO".

Error codes:

AS - Room Temperature Sensor Error

HS - Electric Heating Sensor Error

- - **Evaporator Temperature Sensor error**

Unplug the unit and plug it back in.

If error repeats, call Consumer Services

NOTE: If an error code occurs in Fan only mode, the unit will display "LO" (loose connection) or "HI" (short circuit).

CAUTION If the unit breaks off unexpectedly due to the power cut, it will restart with the previous function setting automatically when the power resumes.

ADDITIONAL THINGS YOU SHOULD KNOW

Now that you have mastered the operating procedure, here are more features in your control that you should become familiar with.

- The Cool circuit has an automatic 3 minutes time delayed start if the unit is turned off and on quickly. This prevents overheating of the compressor and possible circuit breaker tripping. The fan will continue to run during this time.
- The control is capable of displaying temperature in degrees Fahrenheit or degrees Celsius. To convert from one to the other, press and hold the Up and Down (or +/- symbols) buttons at the same time for 3 seconds.

ADJUST YOUR AC DIRECTION

⚠ CAUTION Do not stick your fingers in the air outlet, it may cause an injury.

FOUR-WAY ADJUSTMENT (UP OR DOWN, LEFT OR RIGHT)

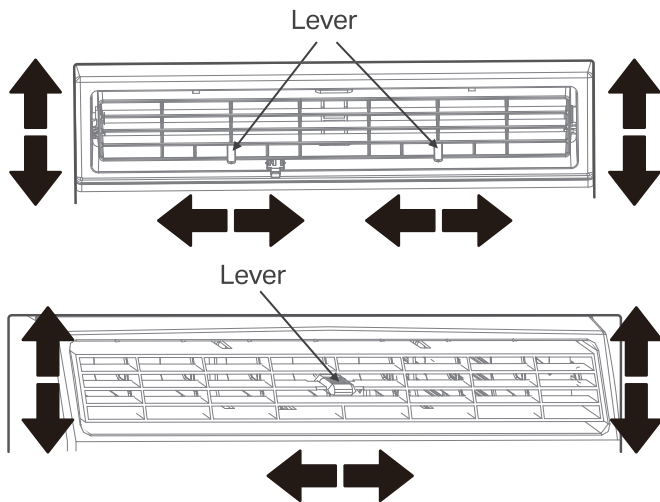

The louvers will allow you to direct the air flow Up or Down and Left or Right throughout the room as needed. Pivot horizontal louvers until the desired Up/Down direction is obtained. Move the Lever(s) from side to side until the desired Left/Right direction is obtained.

FRESH AIR VENT CONTROL

4AW10000A & 4AW12000A only

The Fresh Air Vent allows the air conditioner to:

1. Recirculate inside air - Vent Closed (**See Fig.A**)
2. Draw fresh air into the room - Vent Open (**see Fig.B**)
Knob is half extended.
3. Exchange air from the room and draws fresh air into the room - Vent and Exhaust Open (**see Fig.C**)
Knob is fully extended.

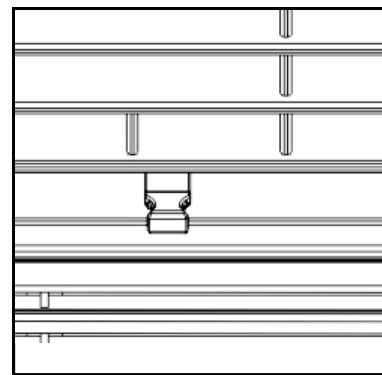

Fig. A (VENT CLOSED)

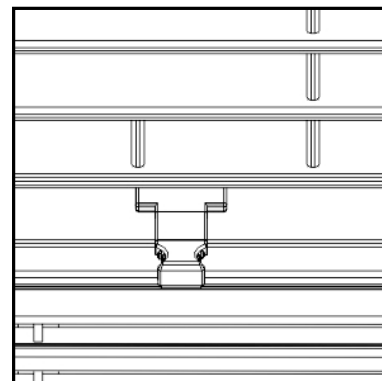

Fig. B (VENT OPEN)

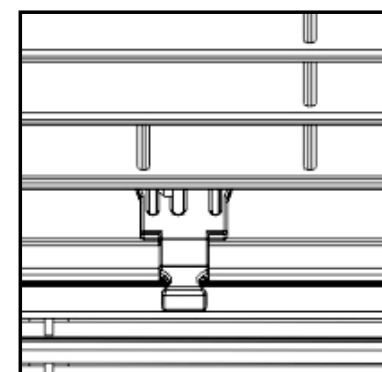

Fig. C (VENT AND EXHAUST OPEN)

CARE & MAINTENANCE

CHECK THE AIR FILTER ONCE A MONTH TO SEE IF CLEANING IS NECESSARY

The air filter should be checked at least once a month to see if cleaning is necessary. Trapped particles in the filter can build up and cause an accumulation of frost on the cooling coils.

If the area usually has high air particle pollution, for example animal fur or smoking, the filter will need to be checked and cleaned more often.

Pull both sides (left and right) of the lower front panel upwards and then out. Refer to the figures on the left for visual guidance.

To clean the filter:

- Remove the filter as shown in the figure on the right.
- Wash the filter using liquid dish washing detergent and warm water.
- Rinse the filter thoroughly.
- Gently shake off excess water from the filter.
- Ensure the filter is completely dry before replacing it.

You can vacuum the filter clean as an alternative to washing.

NOTE: Never use hot water over 104°F (40°C) to clean the air filter. Never attempt to operate the unit without the air filter.

⚠ CAUTION

Clean your air conditioner occasionally to keep it looking new. **Be sure to unplug the unit before cleaning to prevent electric shock or fire hazards.**

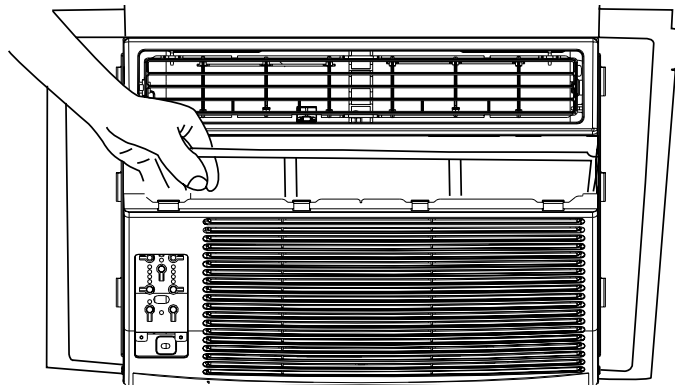

CABINET CLEANING

- Be sure to unplug the air conditioner to prevent shock or fire hazard. The cabinet and front may be dusted with an oil-free cloth or washed with a cloth dampened in a solution of warm water and mild liquid dish washing detergent. Rinse thoroughly and wipe dry.
- Never use harsh cleaners, wax or polish on the cabinet front.
- Be sure to wring excess water from the cloth before wiping around the controls. Excess water in or around the controls may cause damage to the air conditioner.
- Plug in air conditioner.

INSTRUCTIONS FOR WINTER STORAGE

Choose the Storage Location

Select a dry, cool, and indoor location for storage. Avoid places with extreme temperature changes, for example, uninsulated garages, crawlspaces, and sheds should be avoided.

Locate the Original Box

Retrieve the original box and packaging materials that the air conditioner came in. If the original box is unavailable, find a suitable cardboard box that is close in size and provides a snug fit for the unit and accessories.

- 1. Power Down and Unplug:**
Turn off the air conditioner using the power button or remote control. Unplug the unit from the electrical outlet.
- 2. Remove Any Attachments:**
If there are any detachable parts or accessories, such as side accordion panels, carefully remove them from the air conditioner.
- 3. Clean the Air Conditioner:**
Allow the unit to cool down if recently used. Use a soft, damp cloth to clean the air conditioner's exterior, removing dirt or dust.
ALLOW THE AIR CONDITIONER TO DRY A FULL 48 HOURS BEFORE STORAGE
- 4. Position the Air Conditioner in the Box:**
Pack any detachable parts in Step 2 alongside the air conditioner and user manual inside the box. Make sure they are properly secured to avoid damage during storage. Carefully place the air conditioner inside the original or suitable replacement box. Ensure the unit fits securely, leaving little to no room for movement. Never use a tarp, garbage bag, or similar material to wrap the air conditioner, this will trap moisture. Always store upright, NEVER store on the side or upside down!

- 5. Store the Remote Control:**
If your air conditioner has a remote control, remove the batteries before storage to prevent potential corrosion. Always use fresh batteries the following year.
- 6. Seal the Box:**
Close the box securely and seal all the seams and edges using packing tape. This will prevent dust and debris from getting inside during storage.
- 7. Elevate the Air Conditioner:**
Place the air conditioner on a clean and dry surface. Elevate the unit slightly off the ground using wooden blocks or other suitable supports to protect it from moisture damage.

Periodically check the air conditioner during winter to ensure no water or moisture buildup inside the box. If you notice any issues or damage following summer, contact a technician before using the unit again.

TROUBLESHOOTING

Before calling for service, review this list. It may save your time and expense. This list includes common occurrences that are not the result of defective workman-ship or materials in this appliance.

Problem	Solution
AIR CONDITIONER NOT COOLING ROOM, OR NOT BLOWING COLD AIR	Be sure unit is not too large or too small for the area of the room.
	Verify that all doors, windows, curtains and any other openings are closed.
	Verify nothing is obstructing the front grille of unit, such as curtains, etc.
	Allow enough time for room to cool, especially if outside temp is very high.
	Check that the filter is not dirty and louvers are open all the way and blowing in the desired direction.
	Check that unit is set to COOL mode and that temperature is down enough (but not too low).
	If unit is near a heat source, such as a stove, etc., relocate unit.
	If air coming from unit is cool to the touch, then unit is working properly; please double check the first three bullet points above.
	If using Follow Me remote feature, move remote away from unit.
	Temperature sensor behind air filter touching cold coil. These two elements should not be touching. Carefully straighten tube away from coil.
AIR CONDITIONER COOLING BUT ROOM IS TOO WARM - ICE FORMING ON COOLING COIL BEHIND DECORATIVE FRONT	Unplug unit for at least 5 minutes. Follow Reset instructions on plug.
	Outdoor temperature is below 64°F (18°C). To defrost the coil, set to FAN only mode.
	Air filter may be dirty. Clean filter. Refer to Care and Cleaning section. To defrost, set to FAN only mode.
AIR CONDITIONER CYCLING ON AND OFF TOO FREQUENTLY OR NOT ENOUGH	Thermostat is set too cold for night-time cooling. To defrost the coil, set to FAN only mode. Then, set temperature to a higher setting.
	Be sure unit is not too large or too small for the area of the room.
	Remove grille and make sure the temperature sensor is not too close to the coils. These two elements should not be touching. Carefully straighten tube away from coil.
	Make sure nothing is blocking the grille or side vents.
UNIT WILL NOT TURN ON	Make sure there is no dirt or debris inside the unit or on the filter.
	Reset circuit breaker. Make sure there are not too many items (i.e. lamps, TV's, etc.) working off the same breaker.
	Check plug connection.
	If plug is operating on an on/off switch, be sure that the switch is 'on'.
	Try plugging unit into another outlet.
	Unplug unit for at least 5 minutes. Follow Reset instructions on plug.

Problem	Solution
UNIT BLOWS FUSES OR POPS CIRCUIT BREAKER	Make sure there are enough available amps on the circuit for the air conditioner.
	Large units which run on a 230v will require a dedicated 20 or 30 amp circuit.
AIR CONDITIONER IS MAKING NOISES	Check to be sure the unit is free from debris such as leaves, sticks, etc. Verify nothing is obstructing the unit.
	Check the fan blade for cracks or chips.
	Make sure the unit is properly and securely mounted inside the window or wall.
	Clean the air filter.
WATER PUDDLES INSIDE UNIT OR IS COMING INTO ROOM	Adjust the slope of the unit so that it drains downward toward the exterior of the home. (See Installation Instructions.)
	Make sure that there is no debris blocking the drainage area of the unit.
WATER DRIPPING OUTSIDE	Unit is removing a large quantity of moisture from a humid room. This is normal during excessively humid days.
REMOTE SENSING / FOLLOW ME DEACTIVATING PREMATURELY	Remote control not located within range. Place remote control within 20 ft and 180° radius of the front of the unit.
	Remote control signal obstructed. Remove obstruction.

NOTE: A highly recommended troubleshoot for any issue in general consists of turning off unit and unplugging for 5 minutes. It is also recommended to try another wall outlet. For further assistance, contact customer service at 855-663-9463.

The design and specifications are subject to change without prior notice for product improvement. Any updates to the manual will be uploaded to the Arctic Wind website (www.arcticwindac.com), please check for the current version.



5401 Dansher Road
Countryside, IL 60525

855-663-9463 | support@arcticwindac.com | www.arcticwindac.com