

# WOODLAND M-PACT®

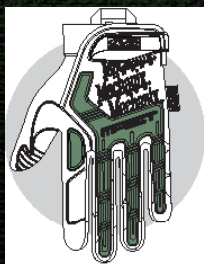

## TACTICAL HAND PROTECTION

The Woodland M-Pact® tactical glove is designed to protect and conceal military and special forces in mountainous regions with varying vegetation. Impact-absorbing Thermoplastic Rubber (TPR) delivers flexible protection in the field against impact injuries and skin abrasions. Our patented Impact Guard™ frees the index finger for smooth trigger guard entry and mobility during hard-charging operations. The dual-layer internal fingertip construction reinforces your thumb and index finger to provide improved abrasion resistance. D30® palm padding absorbs and dissipates high-impact energy through the palm when you're fully engaged so you can maintain your focus.



### NUCKLE GUARD

Impact Guard™ frees the index finger and molded Thermoplastic Rubber (TPR) disperses impact and skin abrasions.

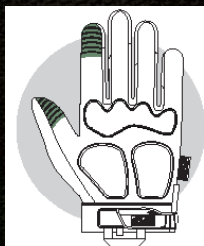





### REINFORCED FINGERTIPS

Dual-layer internal fingertip construction reinforces the index finger and thumb.

# WOODLAND M-PACT<sup>®</sup>

## AVAILABLE COLORS

 MPT-55 COVERT	 MPT-72 COYOTE	 MPT-77 WOODLAND	 MPT-78 MULTICAM	 MPT-88 WOLF GREY
---	---	---	---	--

XXXS	XXS	XS	S	M	L	XL	XXL	XXXL
05	06	07	08	09	10	11	12	13

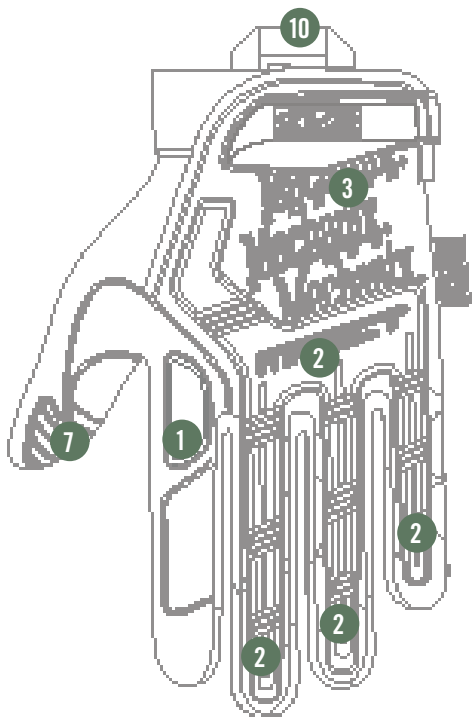

## FEATURES

1. Impact Guard™ protects first knuckle with EVA foam padding.
2. Thermoplastic Rubber (TPR) knuckle guard and finger guards protect against impact.
3. Form-fitting Woodland camo TrekDry® helps keep hands cool and comfortable.
4. Thermoplastic Rubber (TPR) closure with hook and loop provides a secure fit to the wrist.
5. Armortex® palm reinforcement panel.
6. Dual-layer internal fingertip reinforcement provides added durability.
7. Embossed and textured index finger and thumb provides grip.
8. D30® palm padding absorbs dissipates high-impact energy and vibration.
9. Durable synthetic leather palm.
10. Nylon web pull.

## CERTIFICATIONS



## INTENDED USES

- Military
- Law Enforcement
- Shooting Sports
- Maintenance Repair Operations

## FURTHER INFORMATION AVAILABLE AT:

Ref: M-Pact® Woodland

USA  
1-800-222-4296  
CANADA  
1-877-278-5822

Mechanix Wear, Inc.  
28525 Witherspoon Parkway  
Valencia CA 91355  
www.mechanix.com

