

2504653 LENNON 2-4 PERSON CUBE SAUNA Container Loading Diagram

(1 set=6 boxes 44 sets/40HQ, 25 pallets/ 40HQ, Gross Weight: 13716kg)

Top view

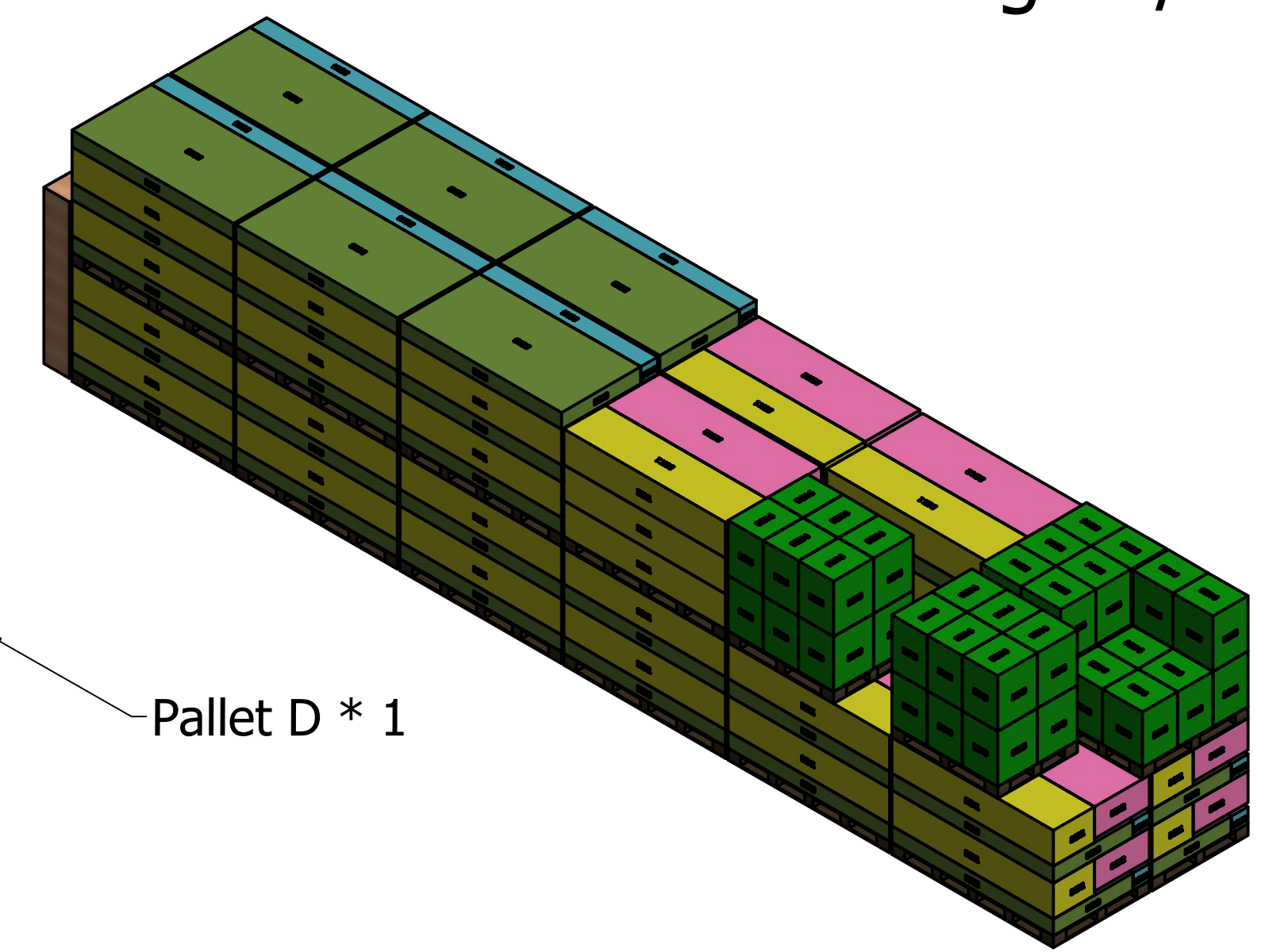
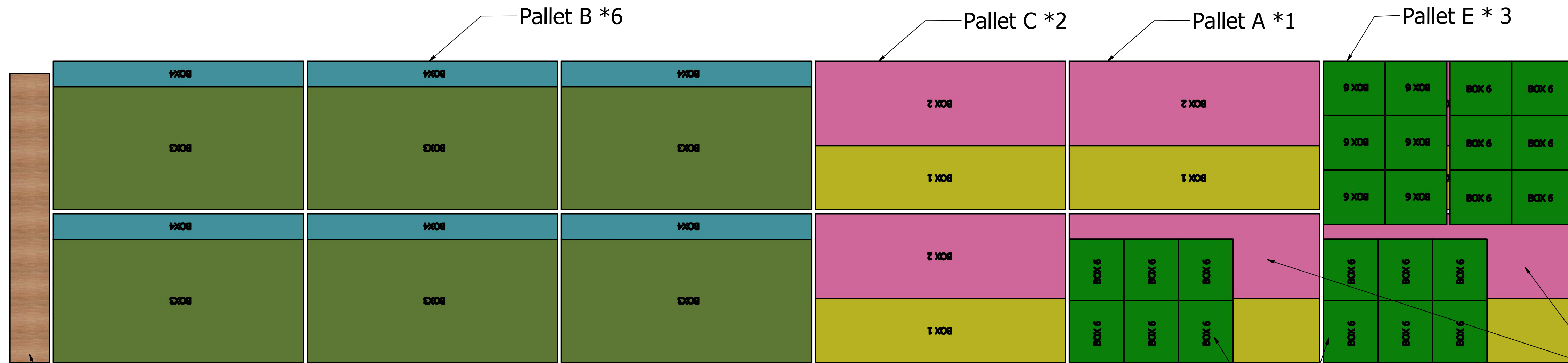

这两个位置需要使用装柜气泡袋进行填充, 避免托盘在运输过程中移动的可能。

这两托Pallet E 需要使用塑钢带与底部托盘进行固定, 避免运输过程中移动。

Side view

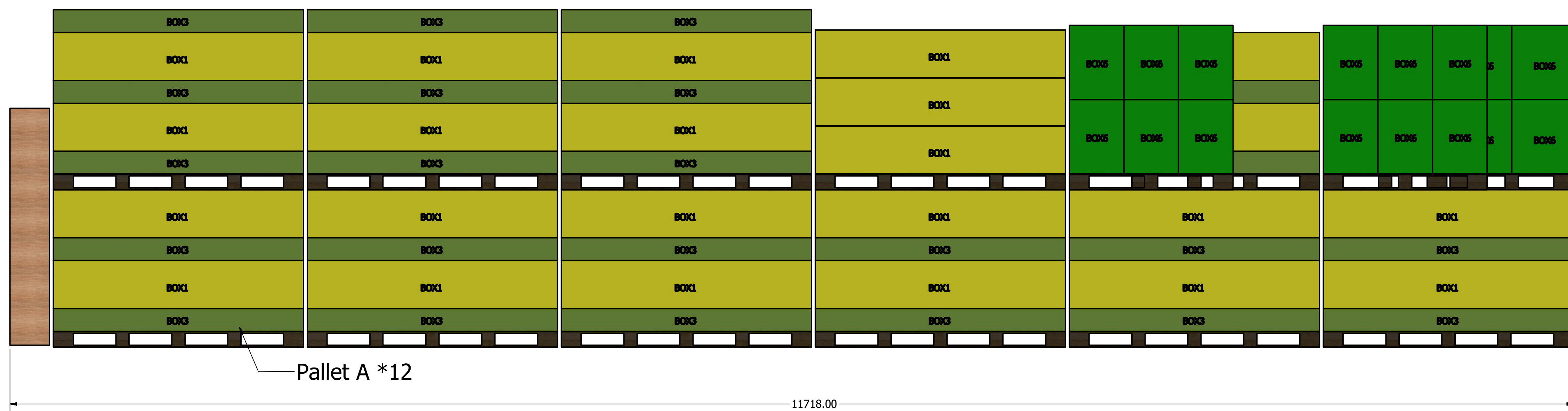

End view

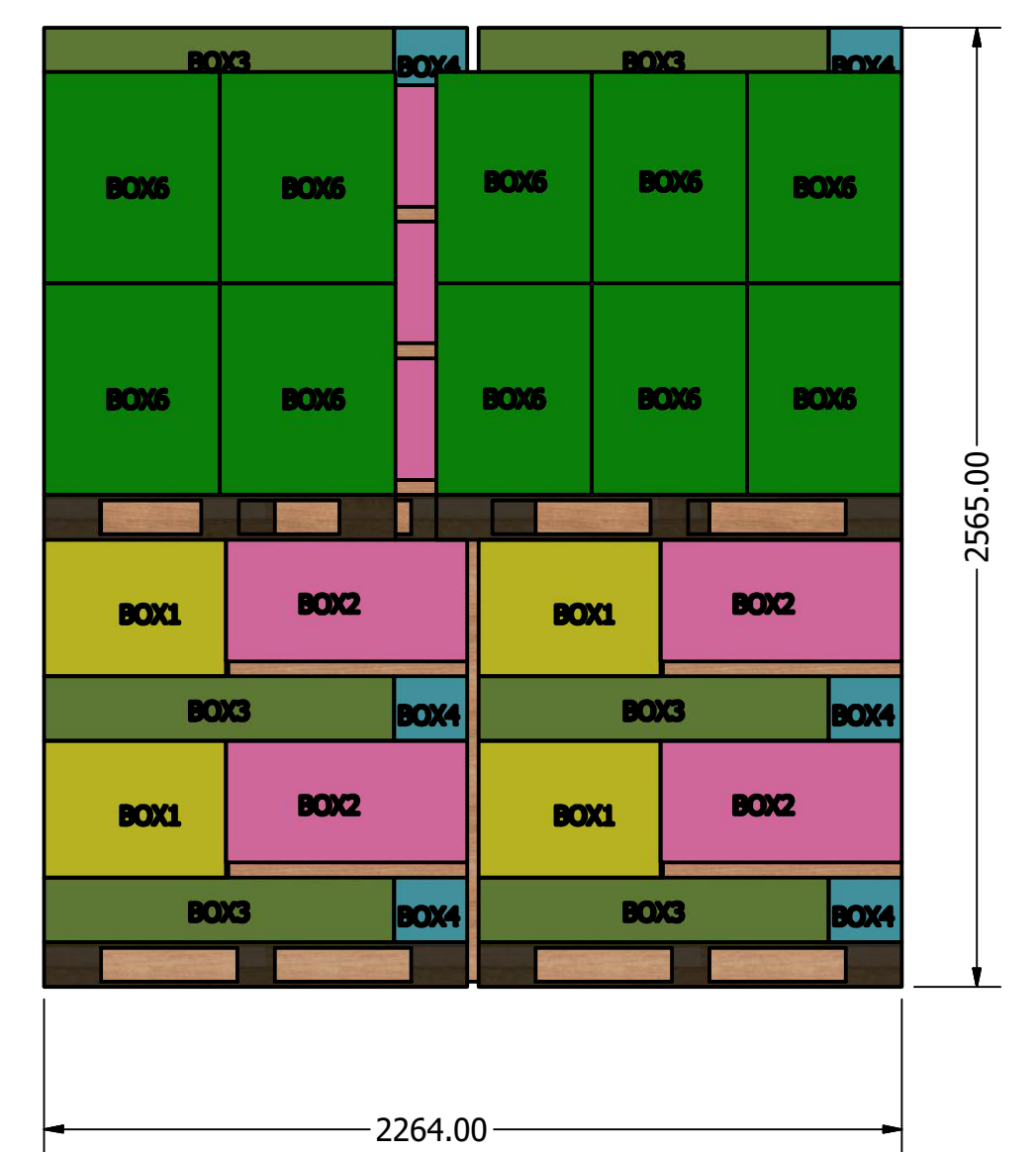

- Pallet A * 13
- Pallet B * 6
- Pallet C * 2
- Pallet D * 1
- Pallet E * 3

DRAWN	Rudy	2019/8/19	TITLE	
CHECKED				
QA				
MFG				
APPROVED				
			SIZE	DWG NO
			D	2006522
			SCALE	1 / 20
				SHEET 1 OF 1

Pallet A (2 wood kits)

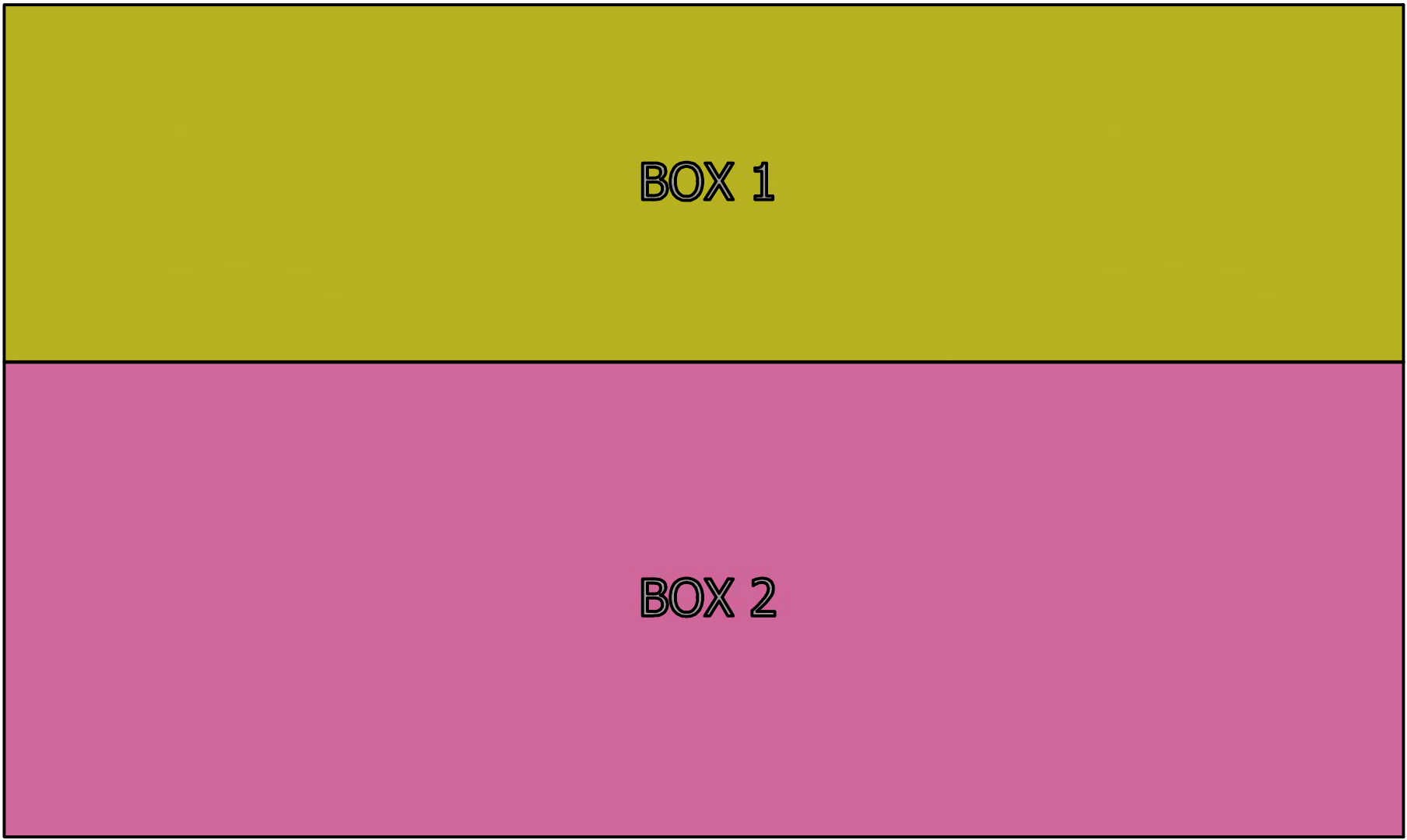

胶合板块 * 2 (640mm*60mm*38mm)
 Plywood block * 2 (640mm*60mm*38mm)

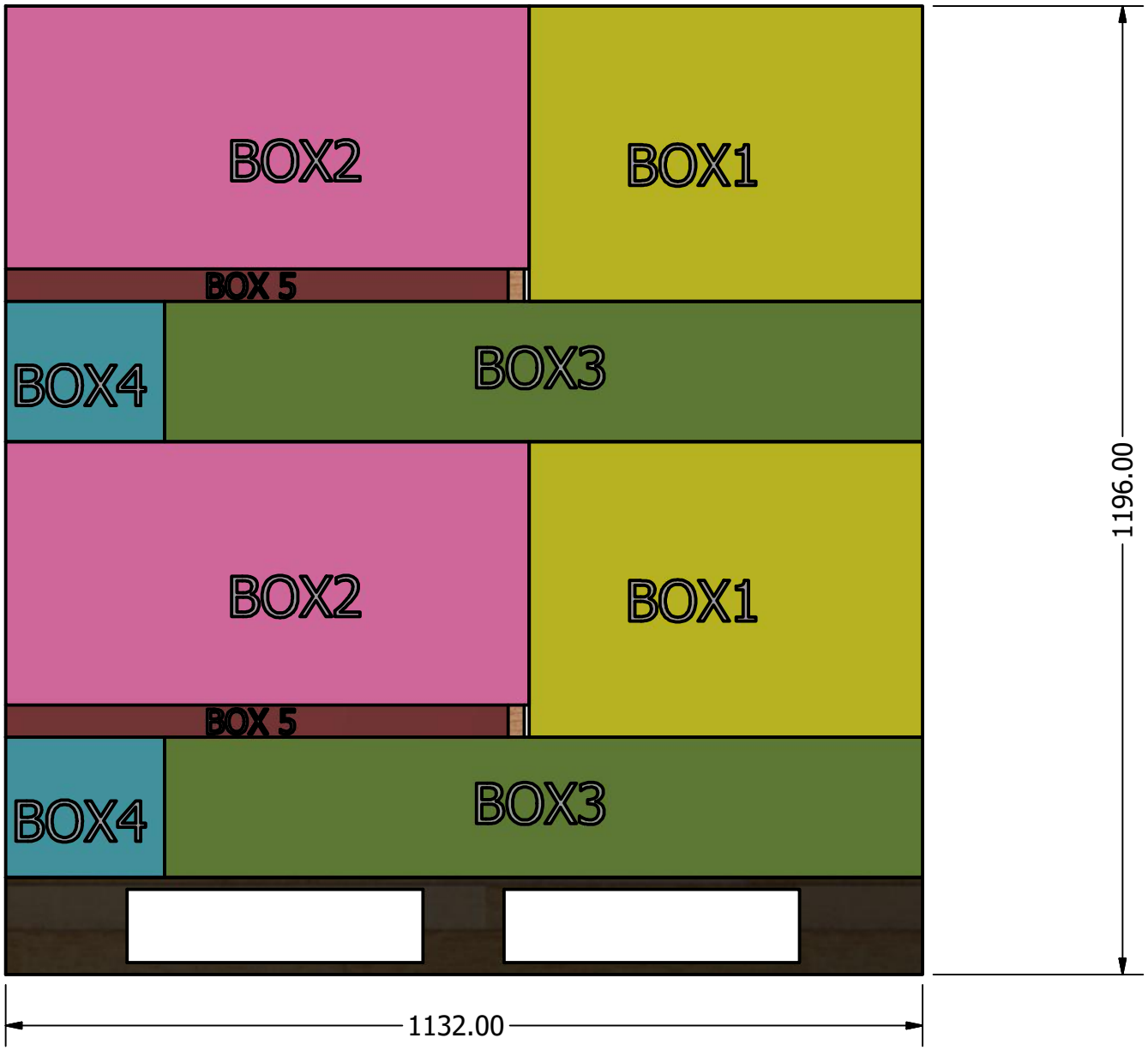
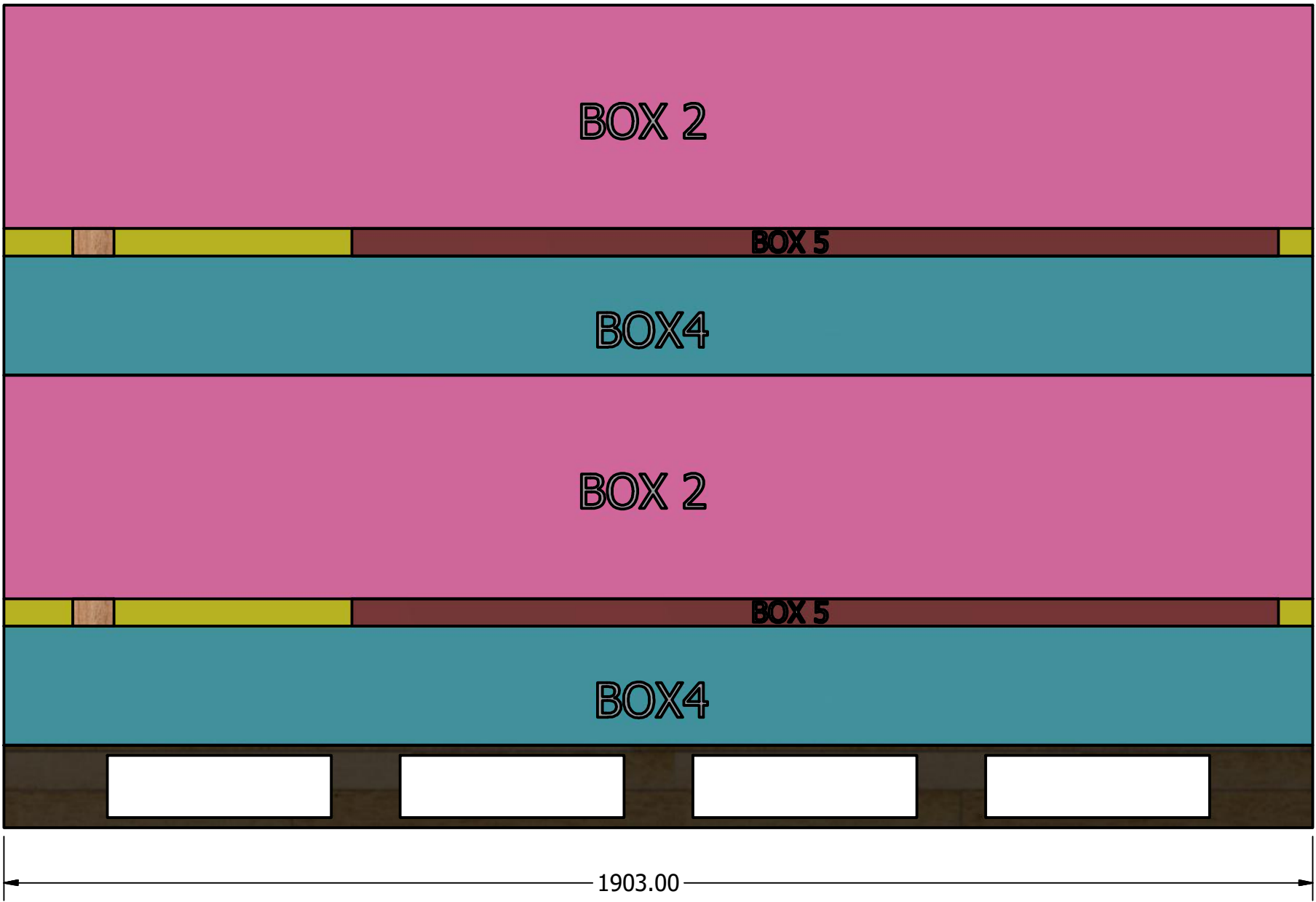
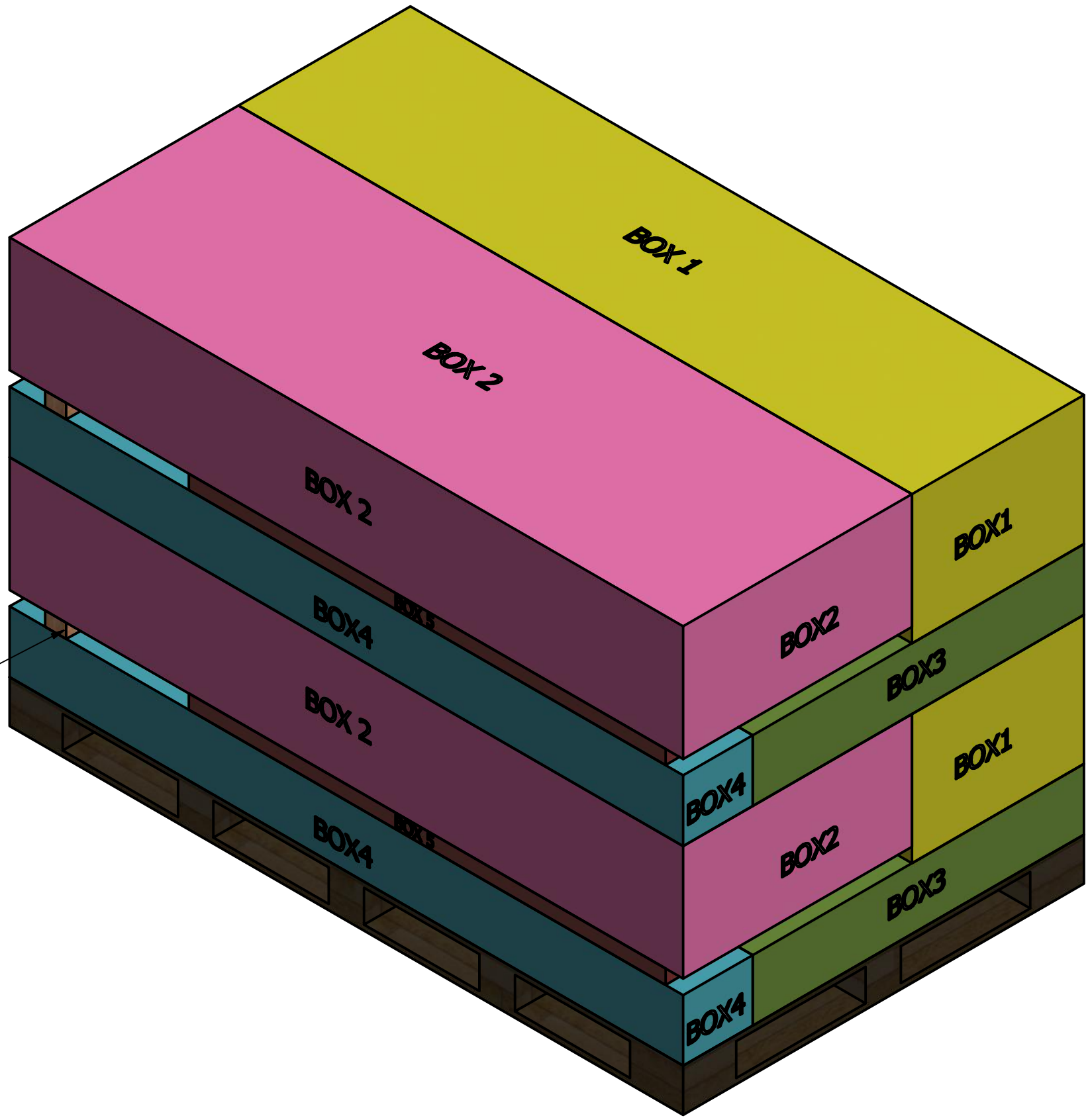

DRAWN		TITLE		
CHECKED		TITLE		
QA		TITLE		
MFG		TITLE		
APPROVED		TITLE		
		SIZE	DWG NO	REV
		D		
		SCALE	SHEET 1 OF 1	
		1 : 10		

Pallet B (2 wood kits+ BOX3*1+BOX4 *1)

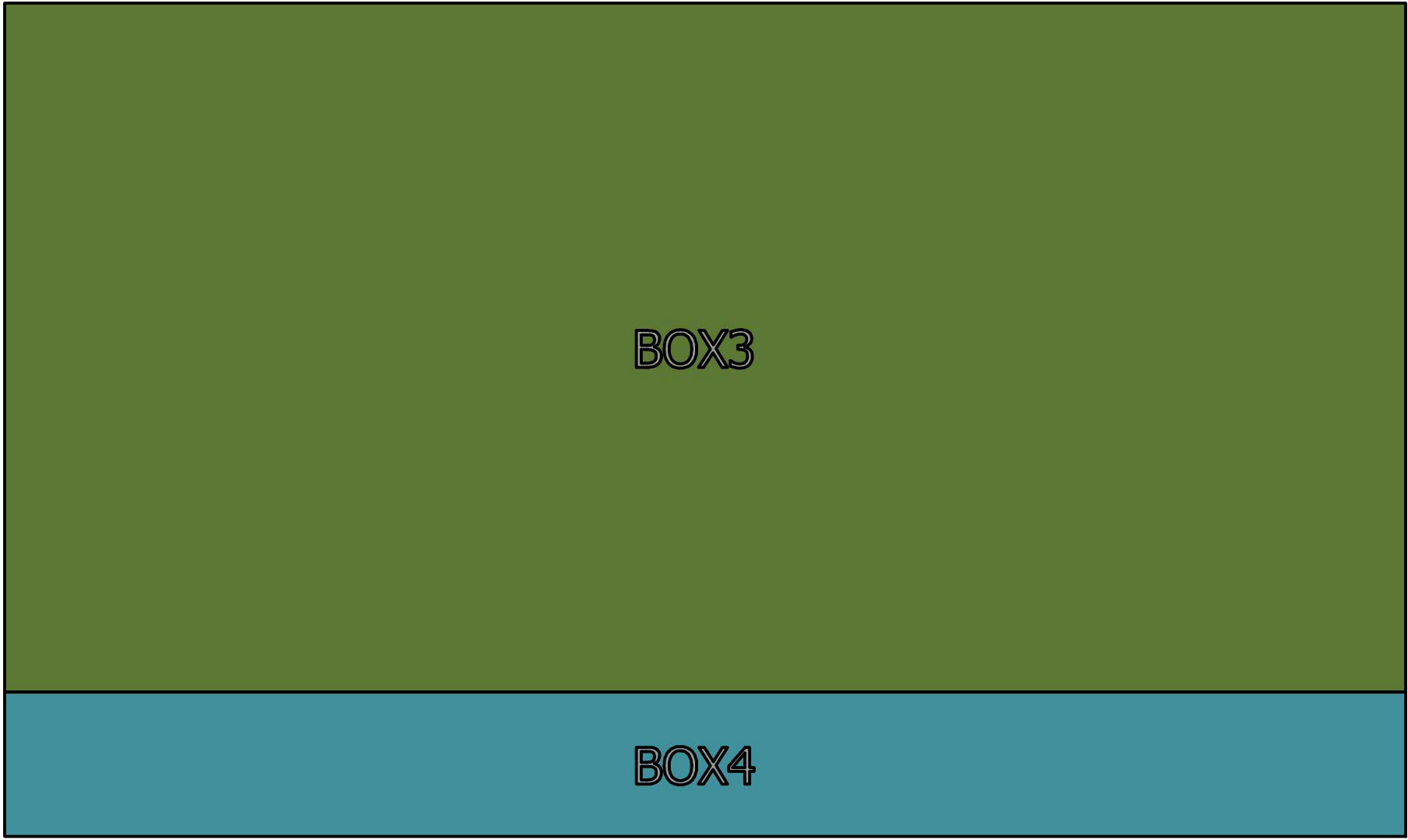

胶合板块 * 2 (640mm*60mm*38mm)
Plywood block * 2 (640mm*60mm*38mm)

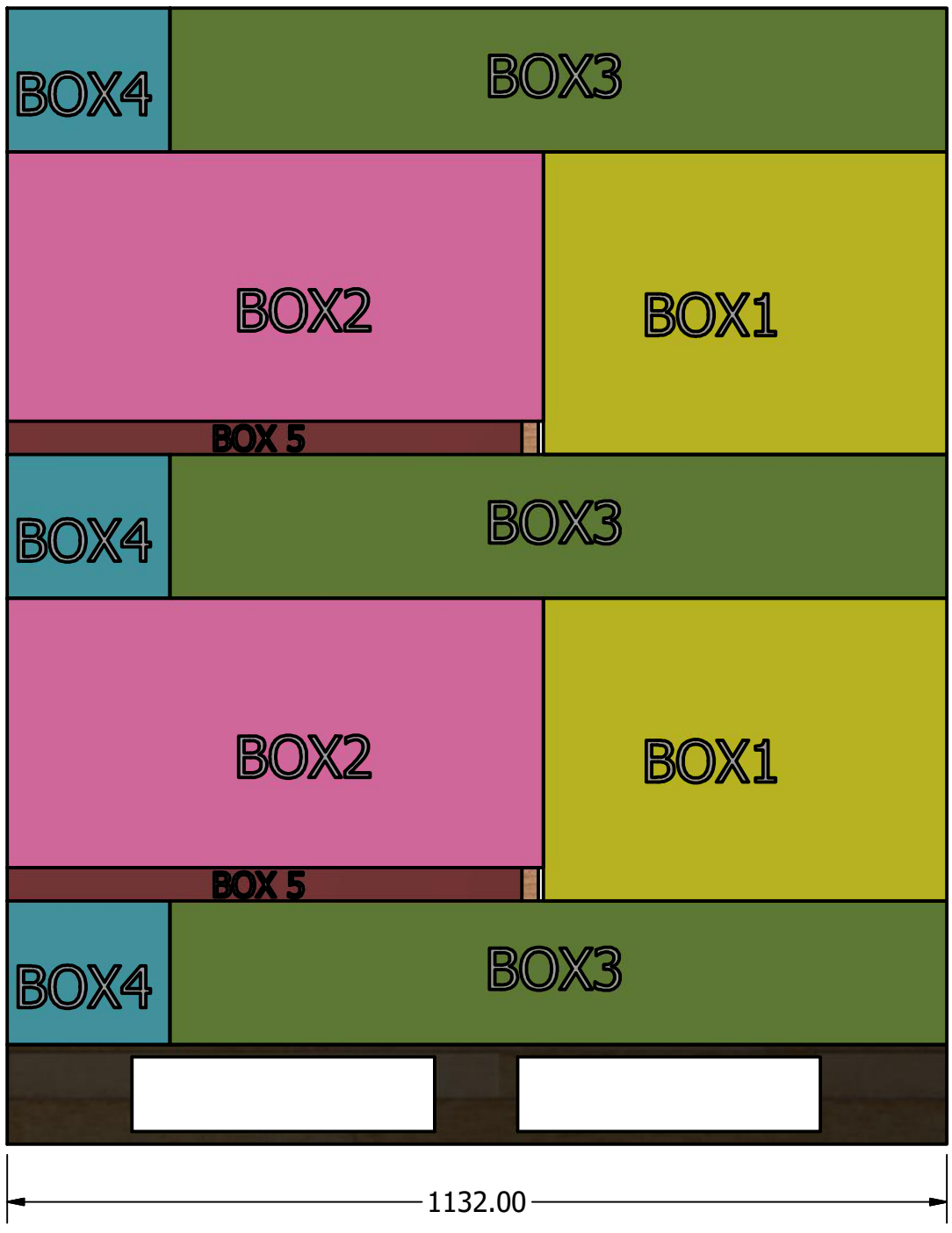
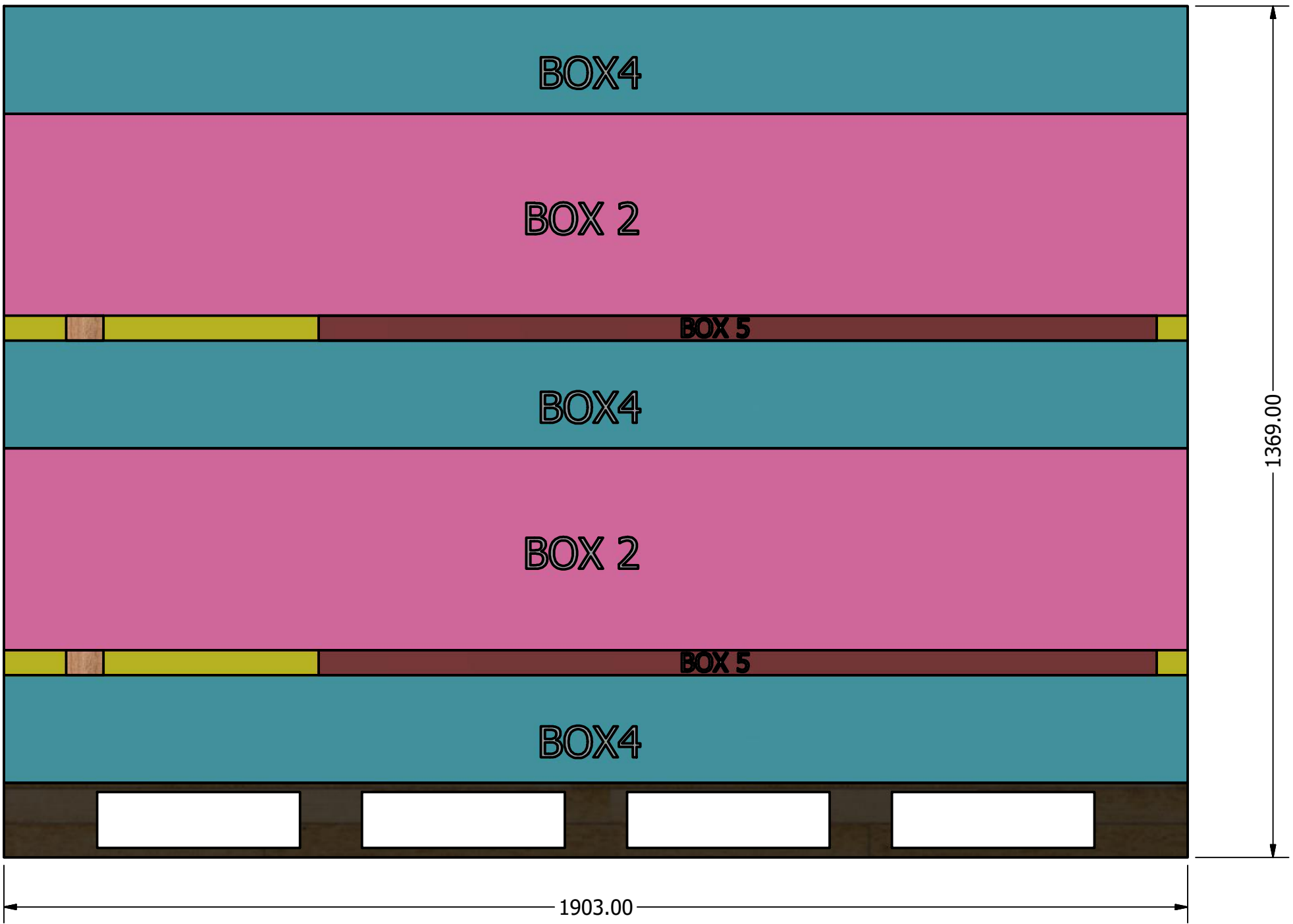
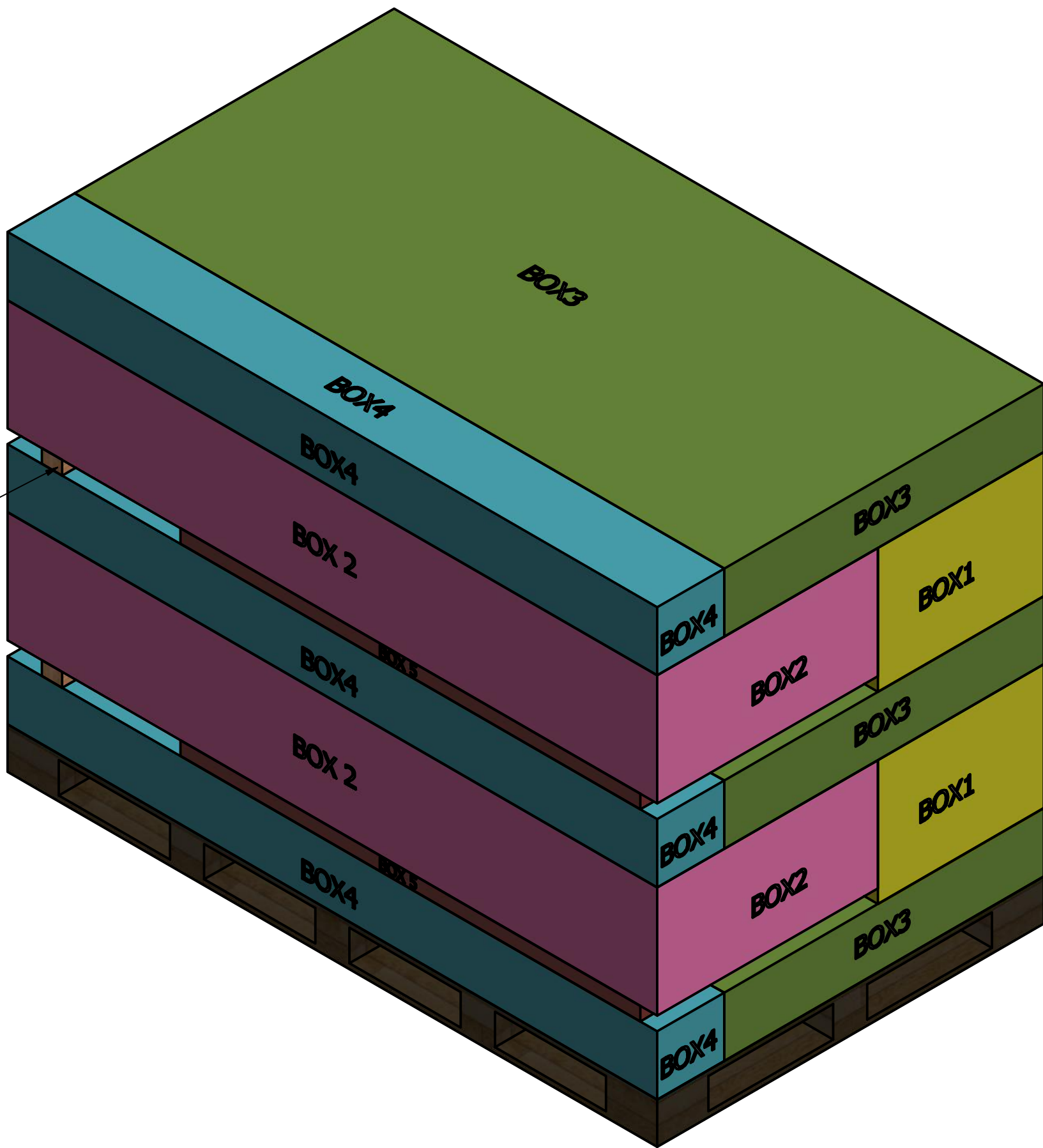

DRAWN		TITLE		
CHECKED				
QA				
MFG				
APPROVED		SIZE	DWG NO	REV
		D		
		SCALE	1: 8	SHEET 1 OF 1

Pallet C (BOX1*3+BOX2 *3+BOX5 *3)

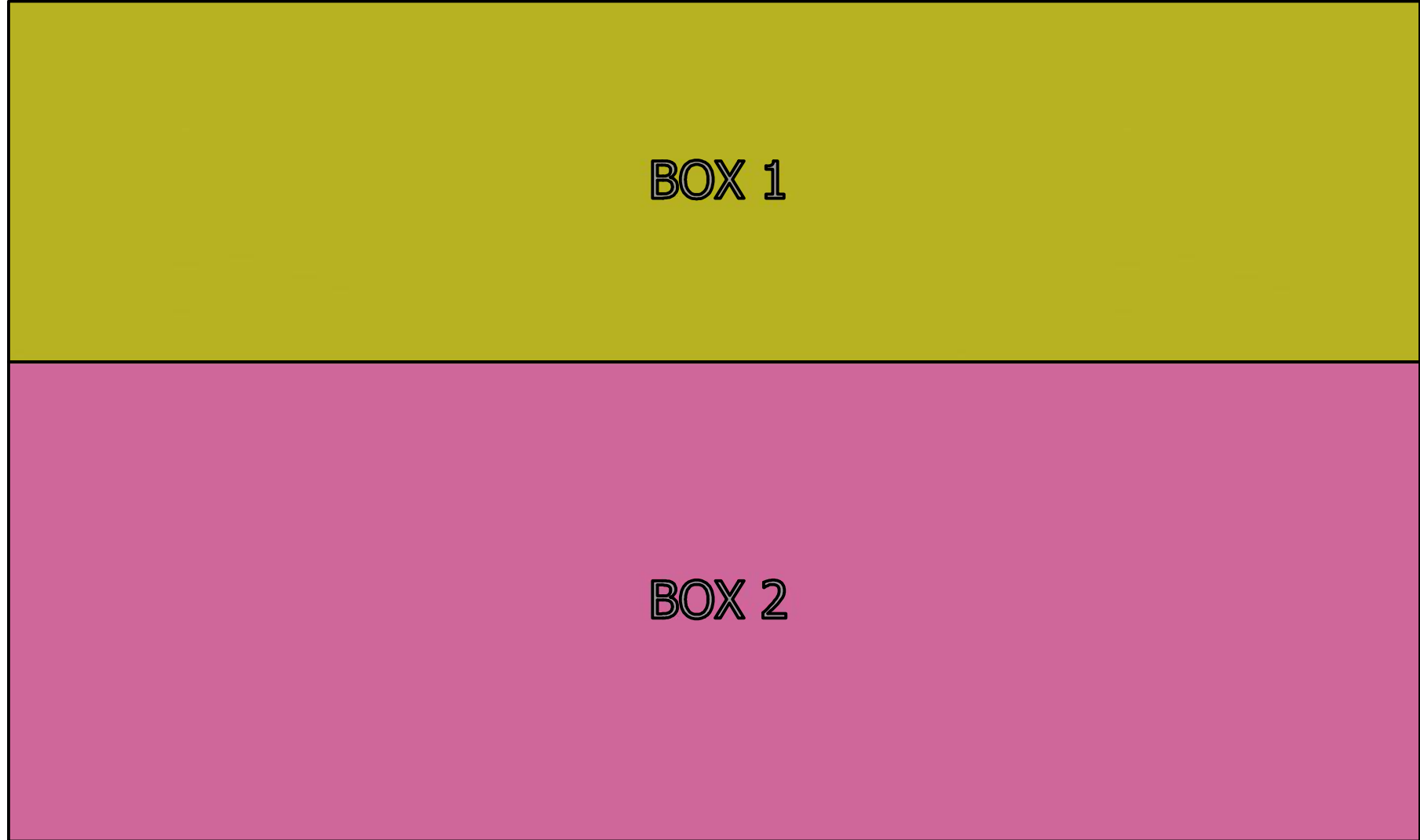

胶合板块 * 3 (640mm*60mm*38mm)
 Plywood block *3 (640mm*60mm*38mm)

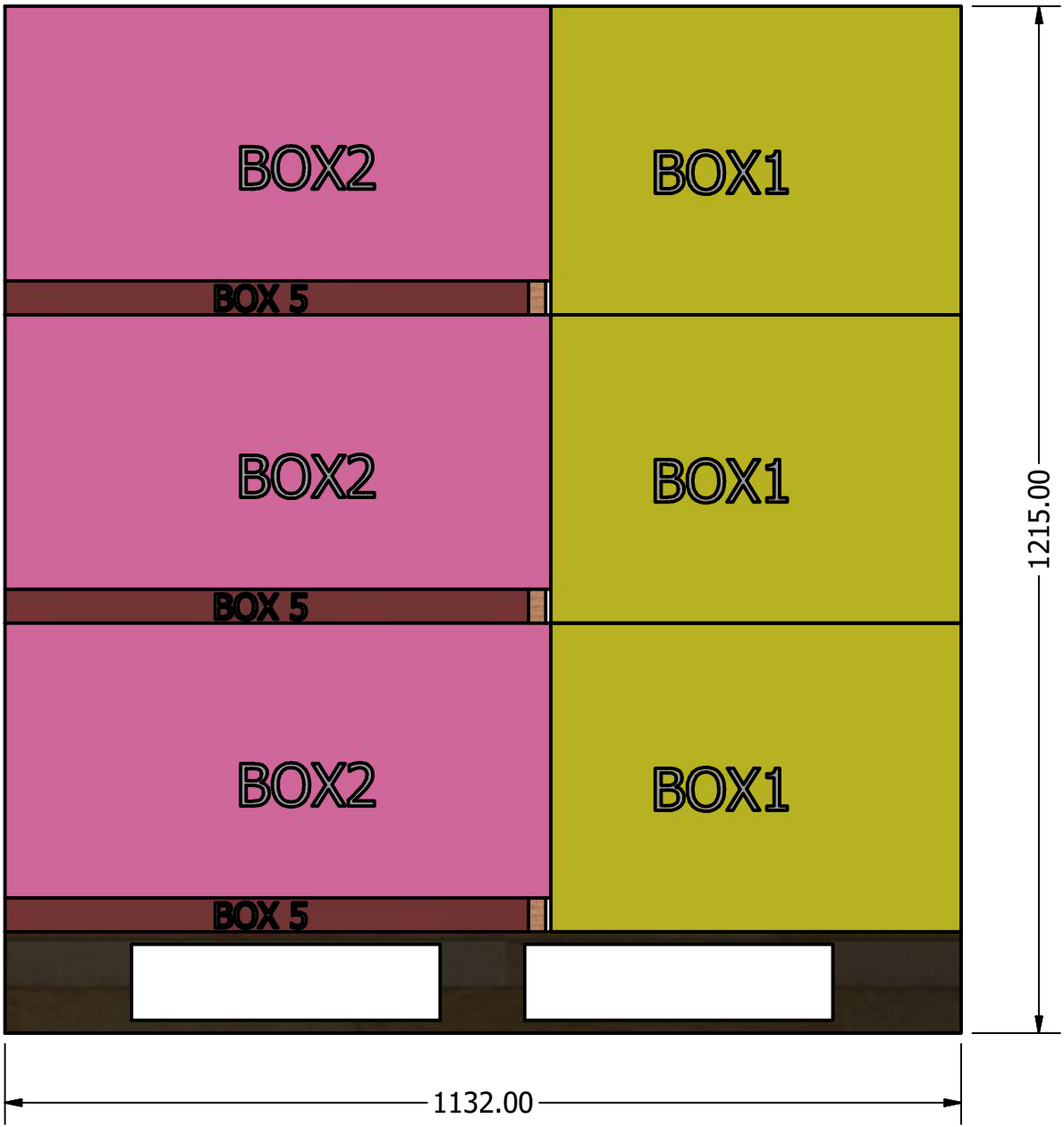
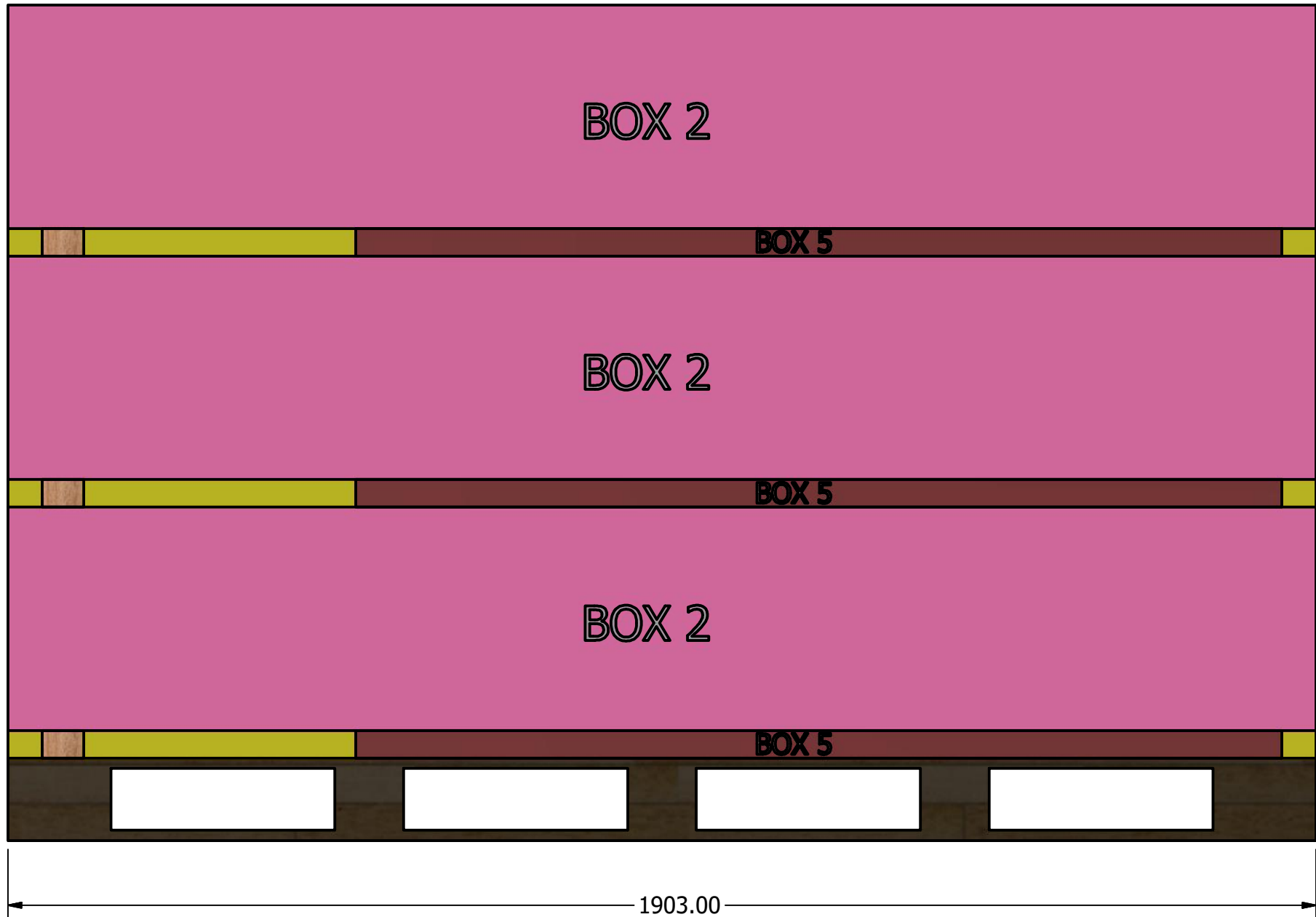
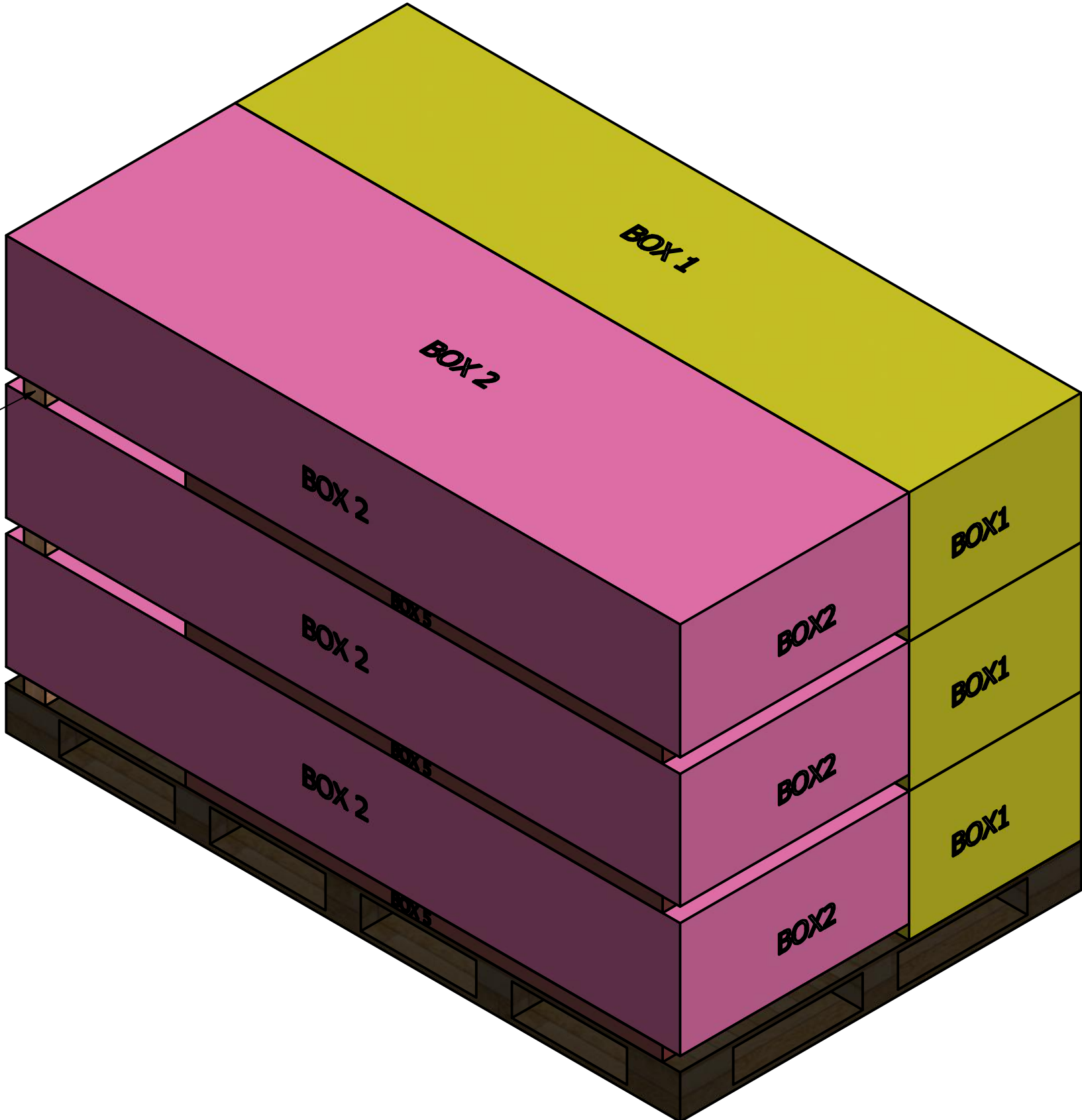

DRAWN		TITLE		
CHECKED				
QA				
MFG				
APPROVED		SIZE	DWG NO	REV
		D		
		SCALE	SHEET 1 OF 1	
		1: 8		

Pallet D (BOX6*8)

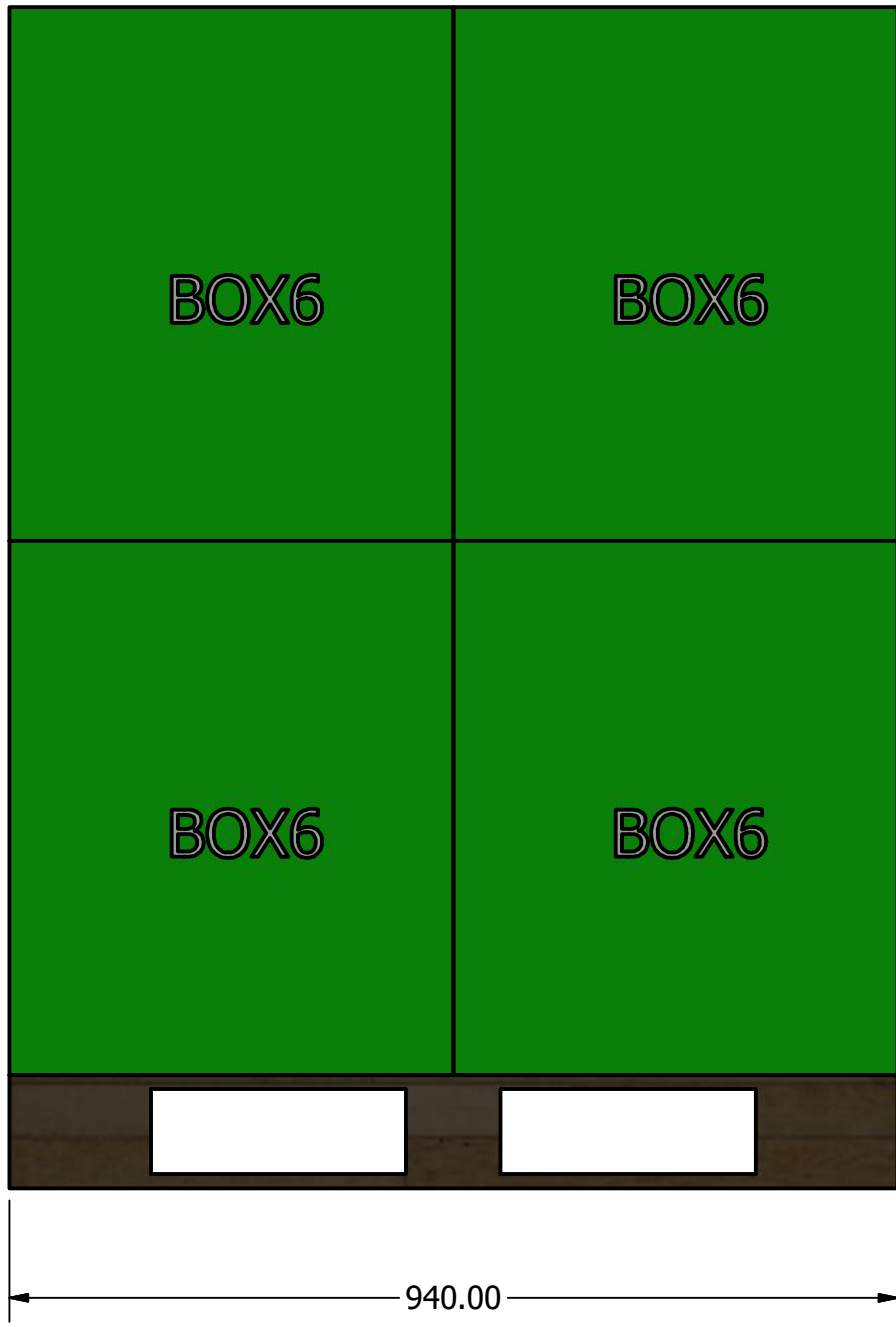
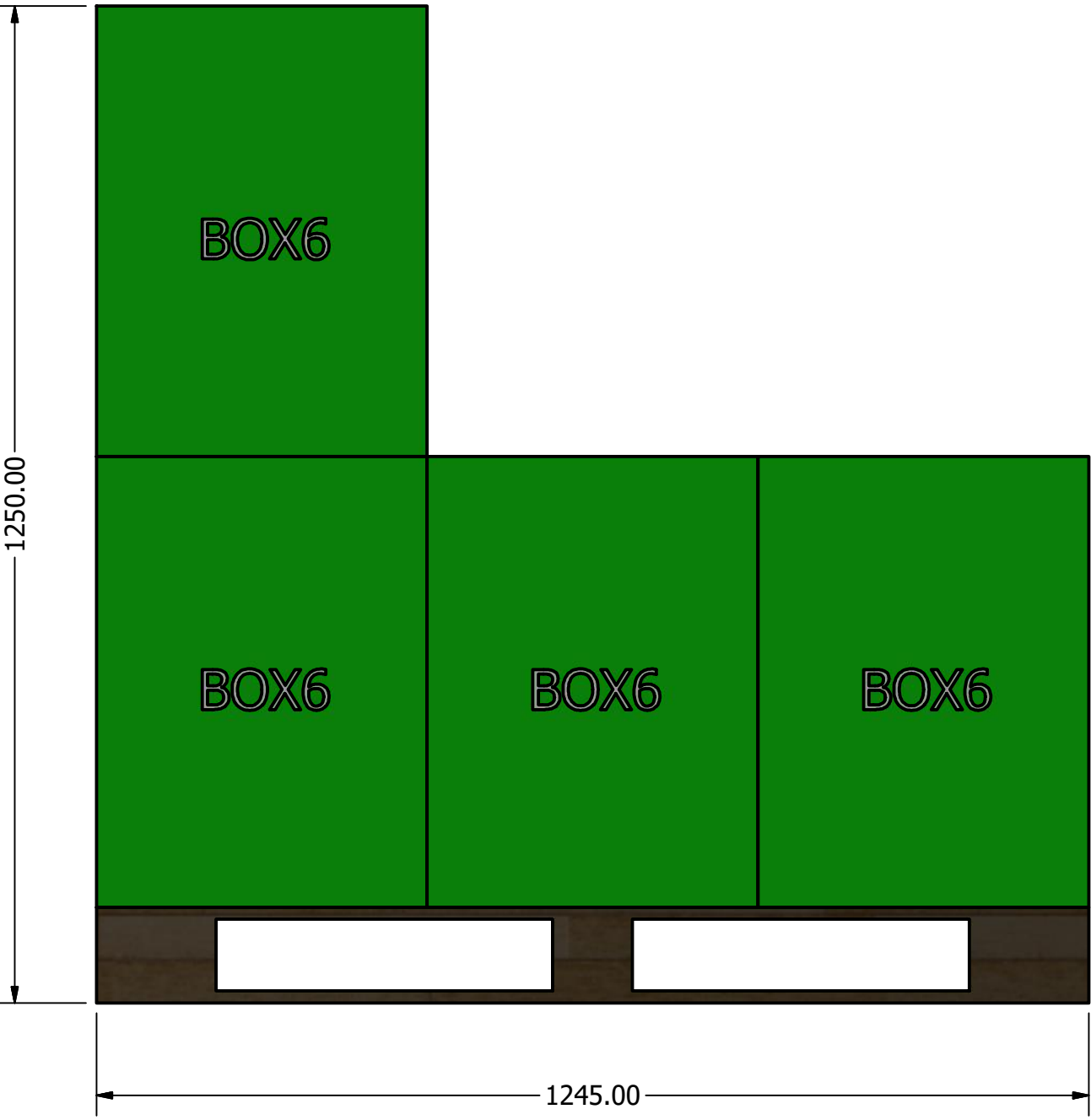
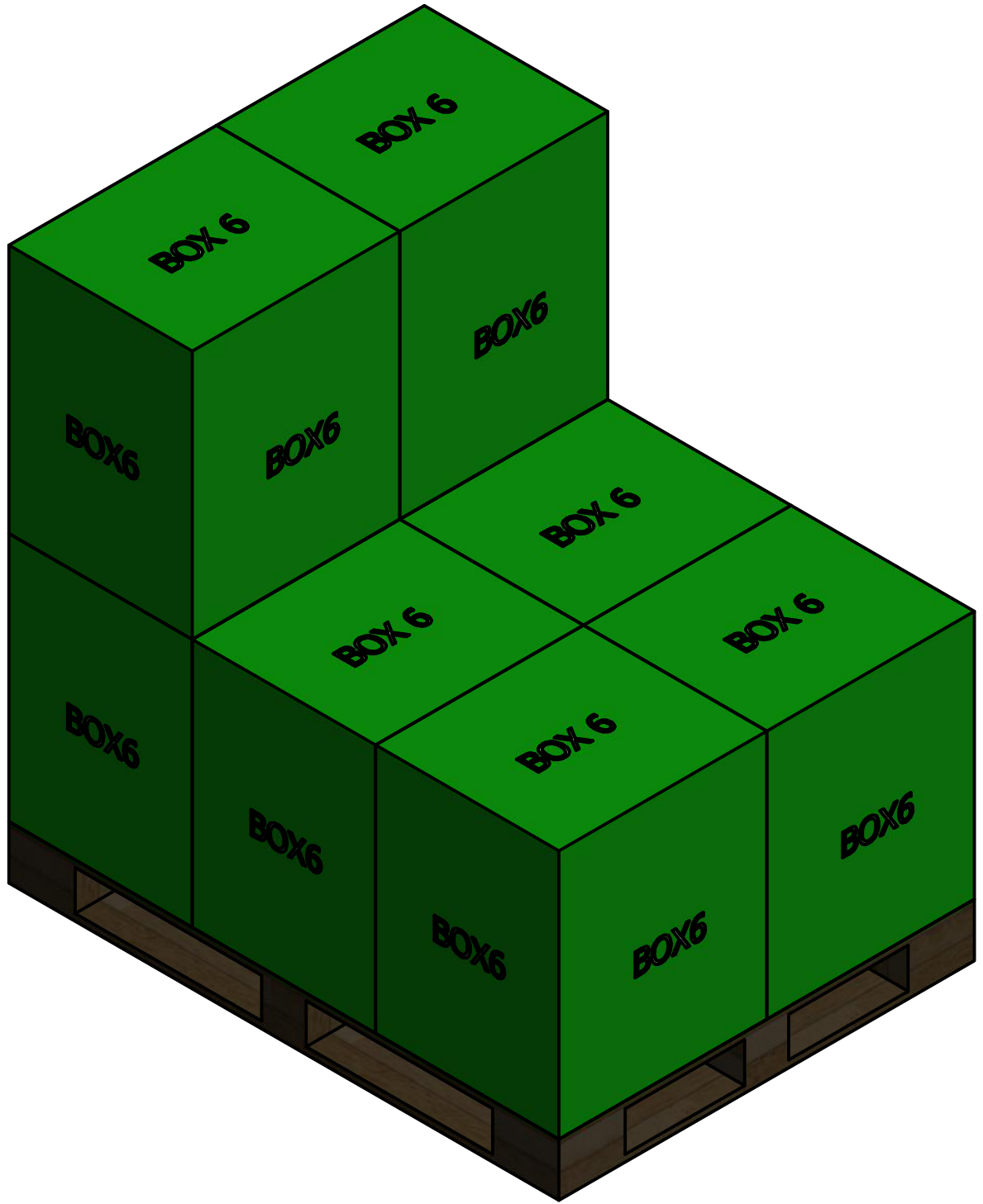
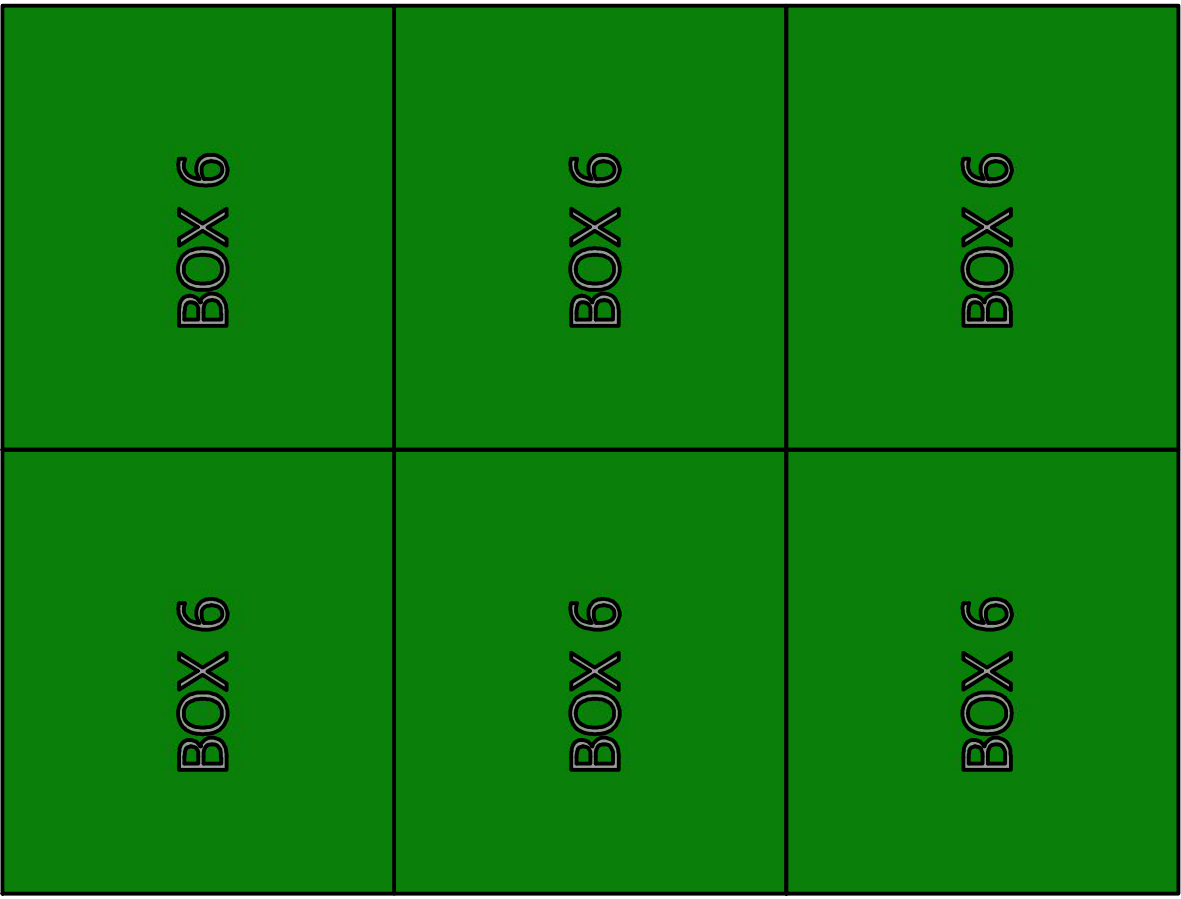

DRAWN				
CHECKED		TITLE		
QA				
MFG				
APPROVED				
		SIZE	DWG NO	REV
		D		
		SCALE	1 : 8	SHEET 1 OF 1

Pallet E (BOX6*12)

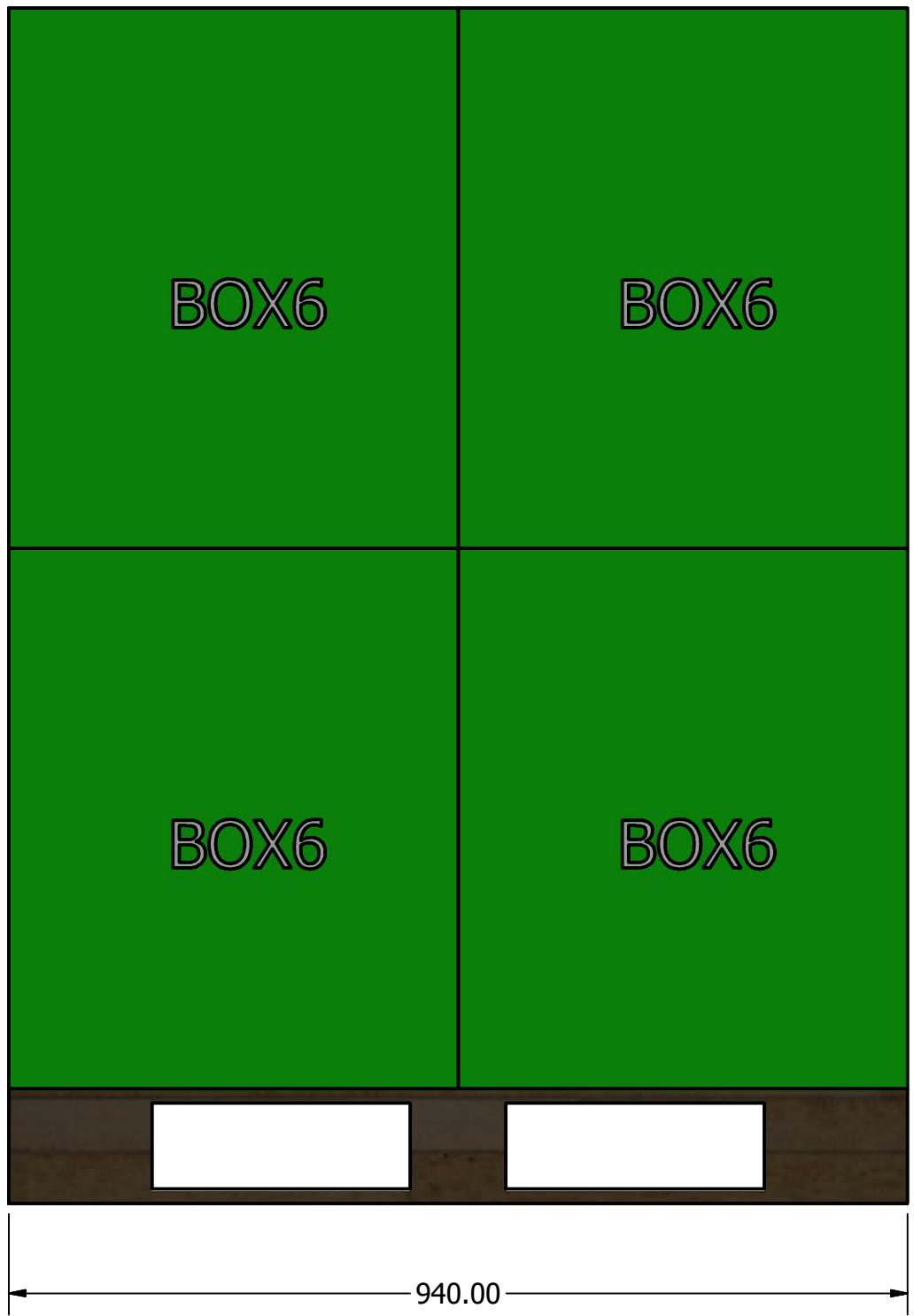
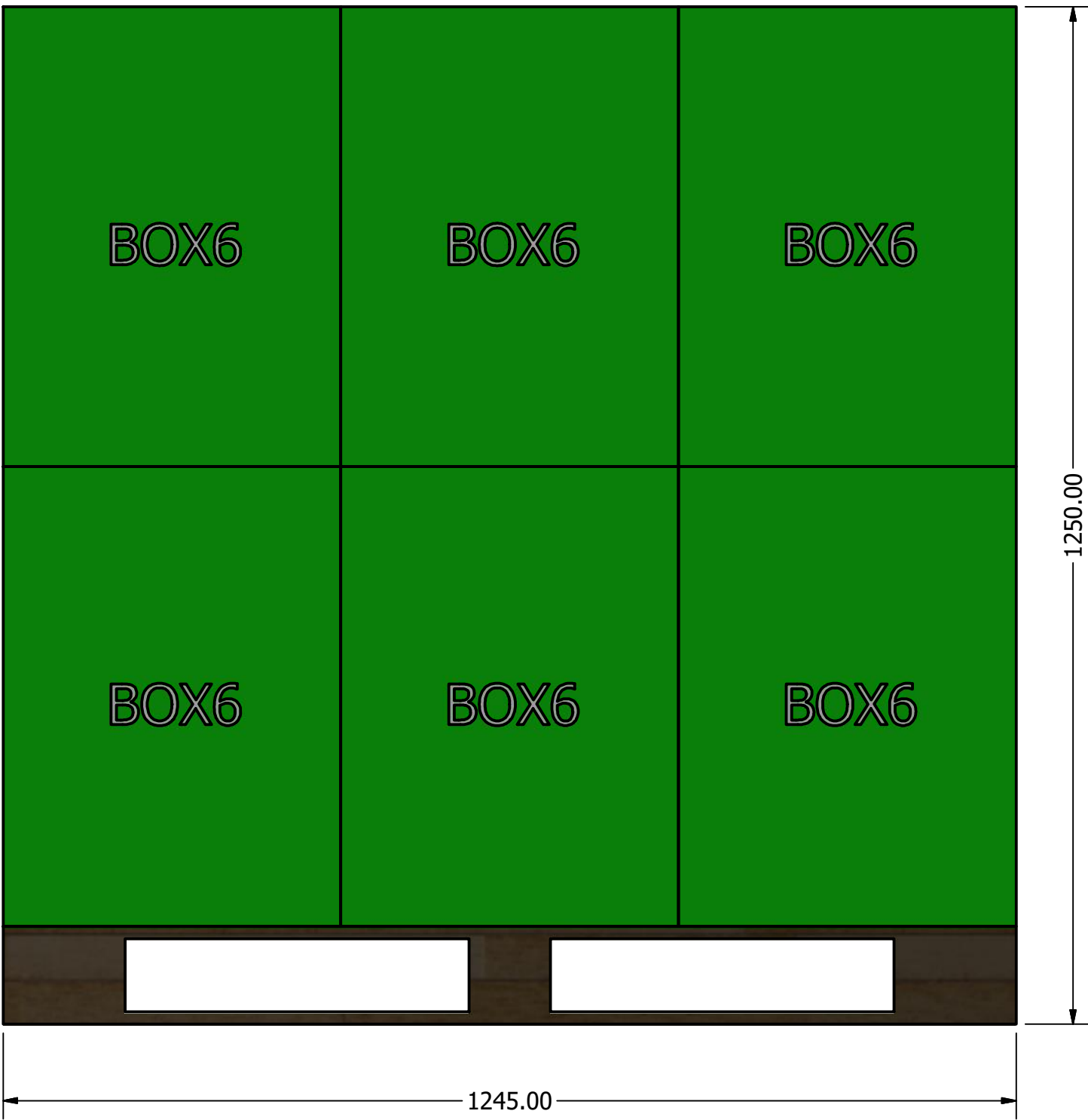
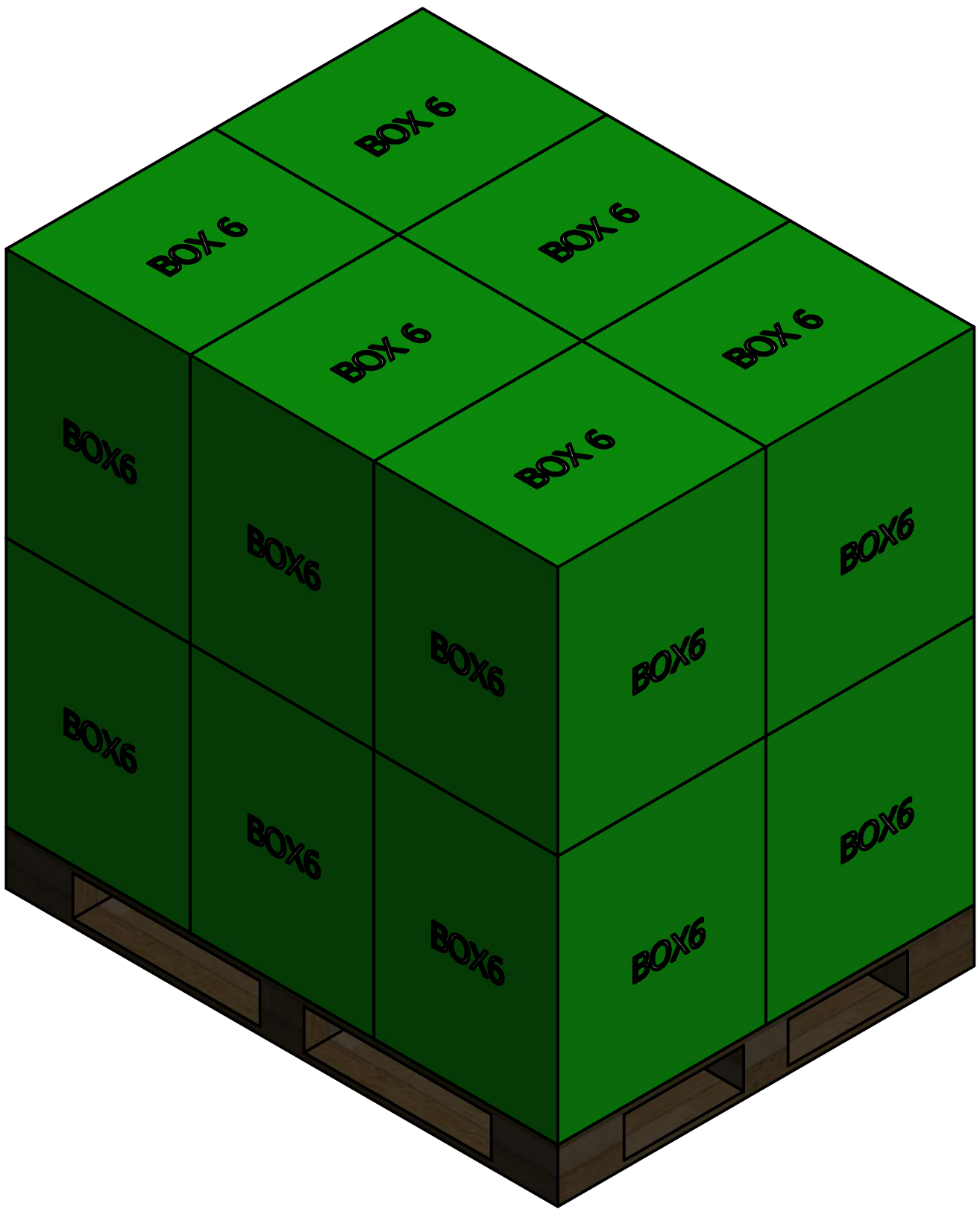
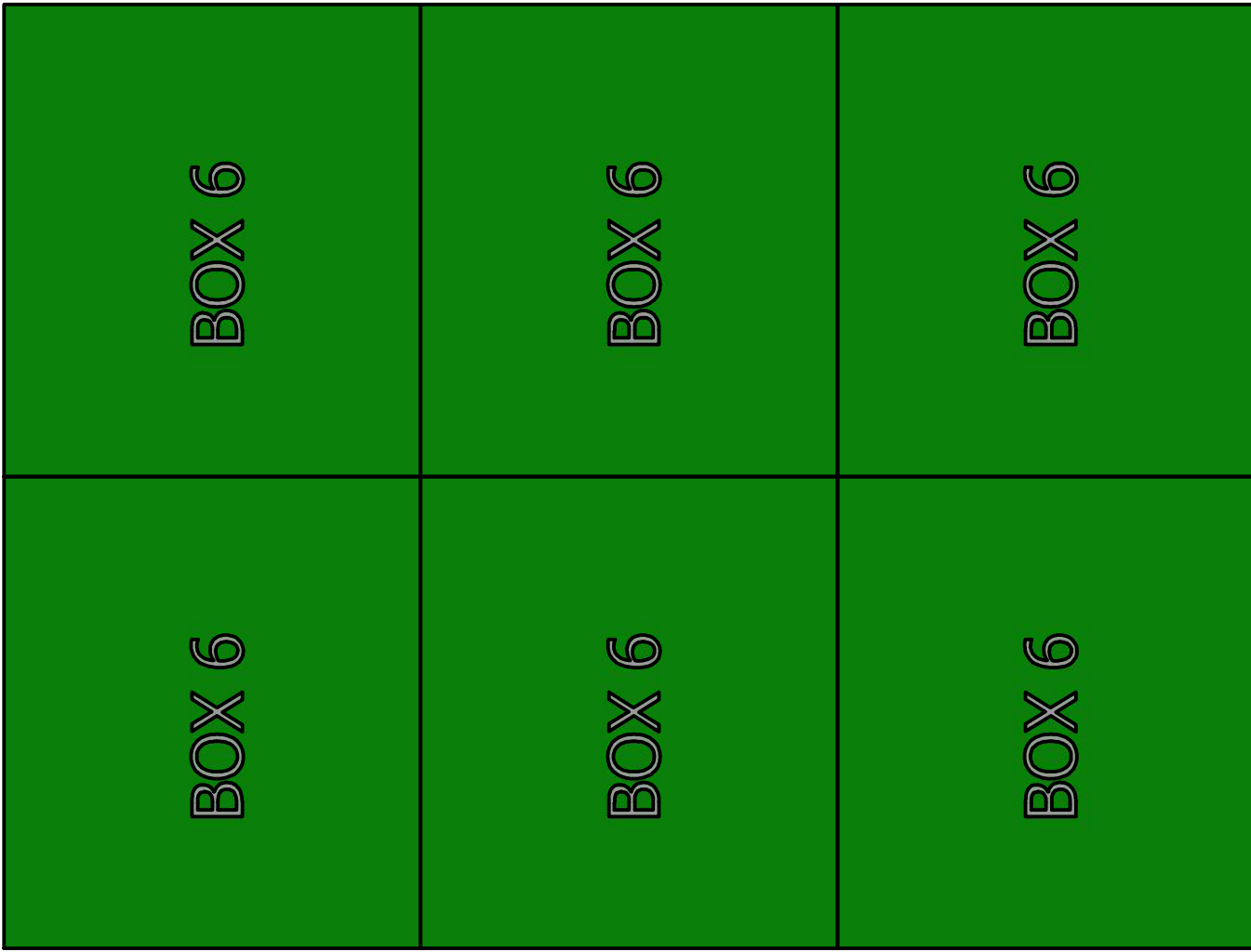

DRAWN		TITLE		
CHECKED		TITLE		
QA		TITLE		
MFG		TITLE		
APPROVED		TITLE		
		SIZE	DWG NO	REV
		D		
		SCALE	1 : 7	SHEET 1 OF 1

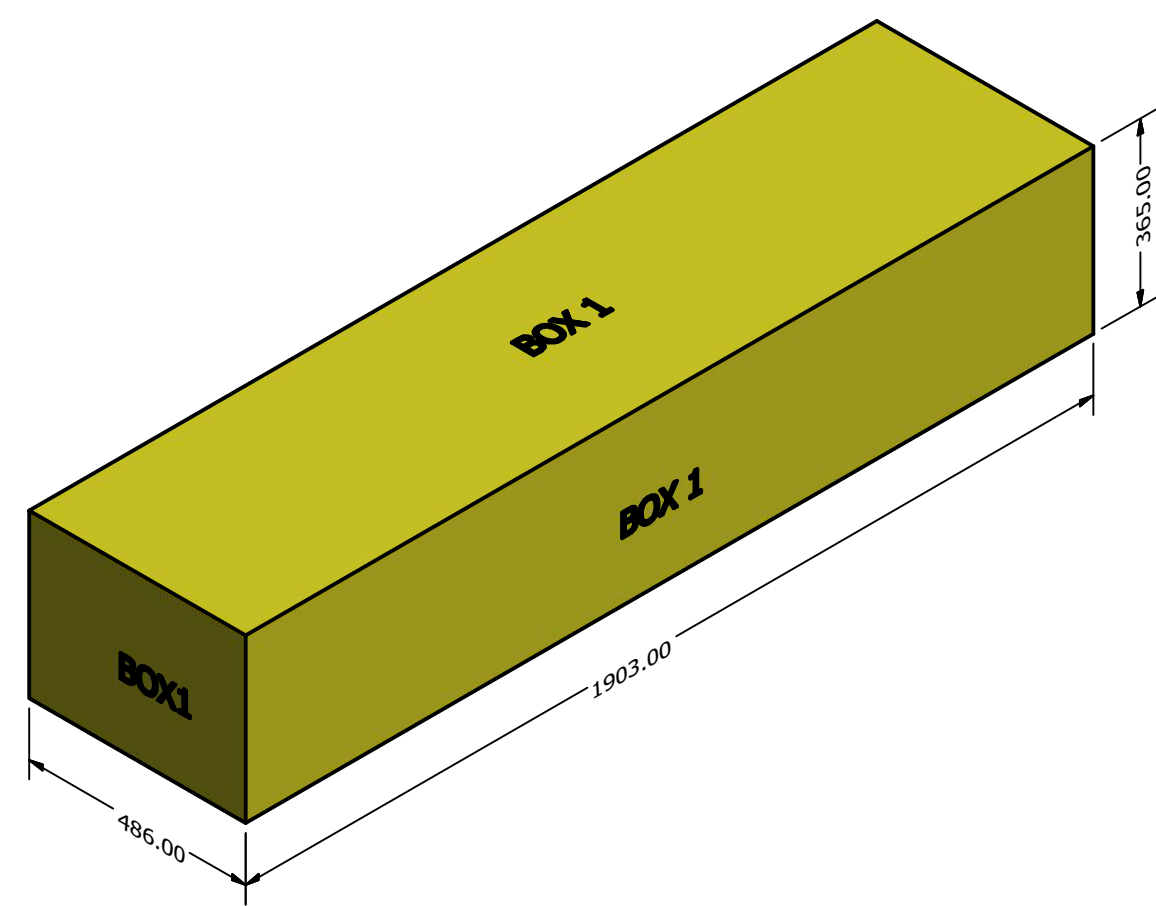

BOX1: 76kg

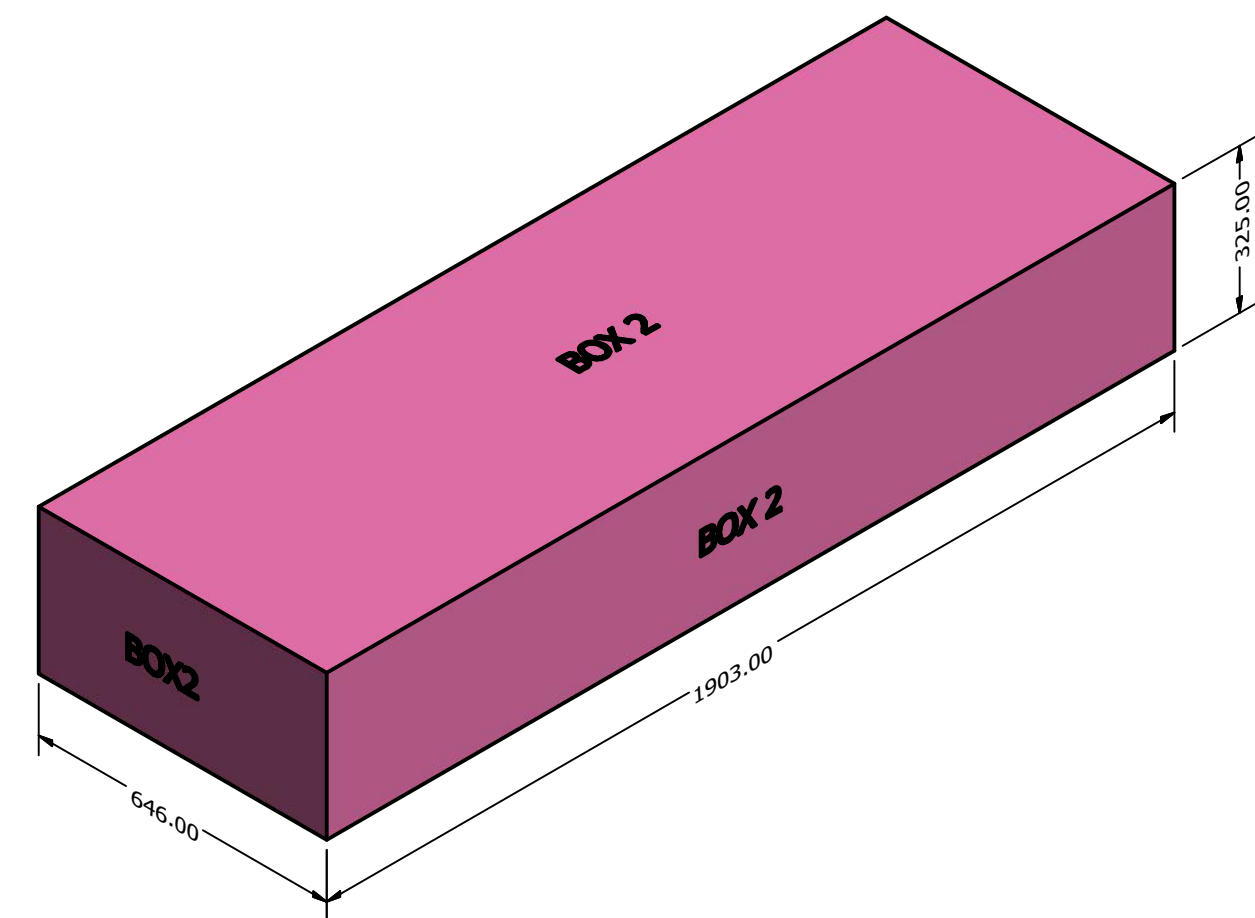

BOX2: 85kg

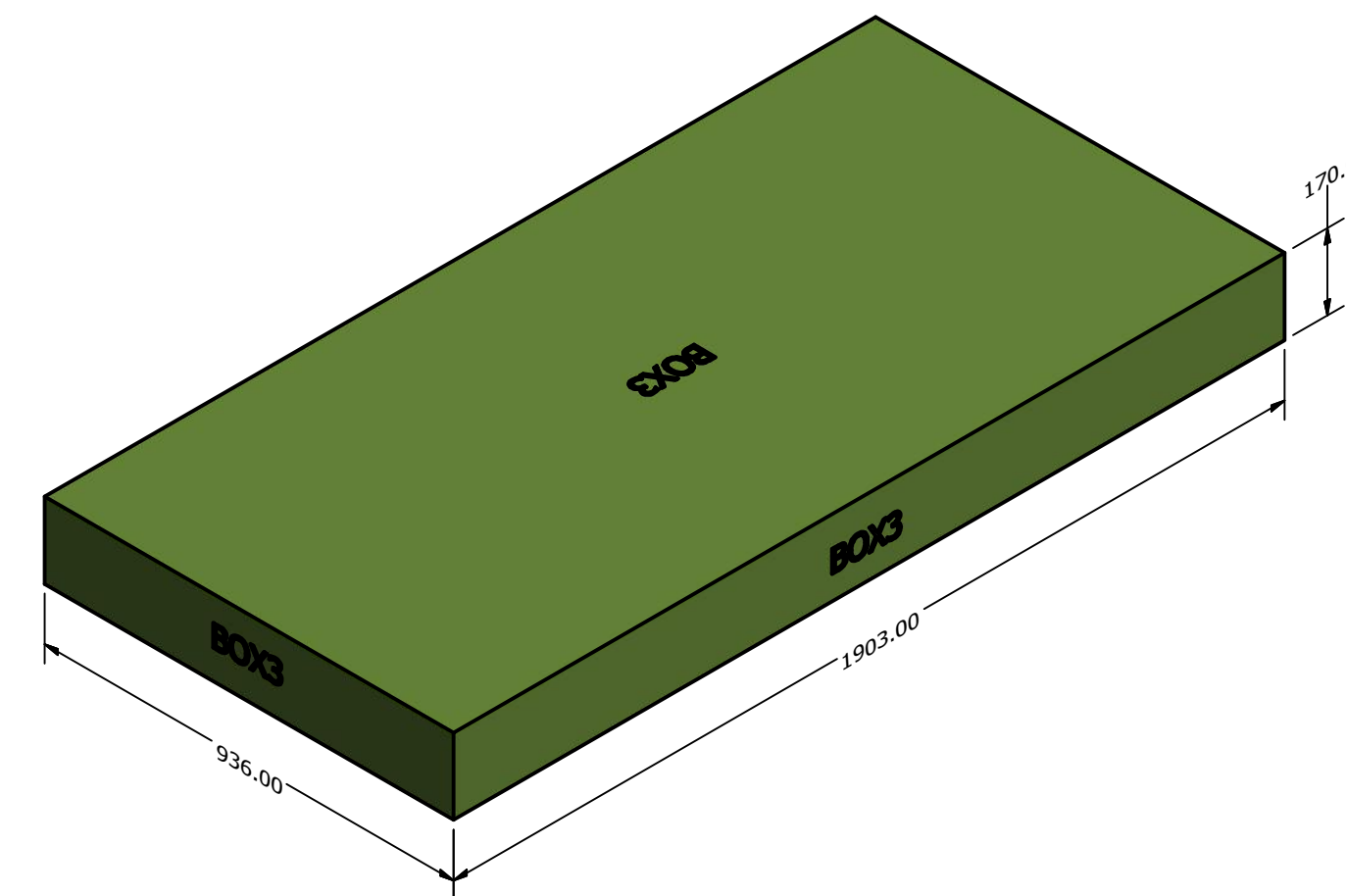

BOX3: 74kg

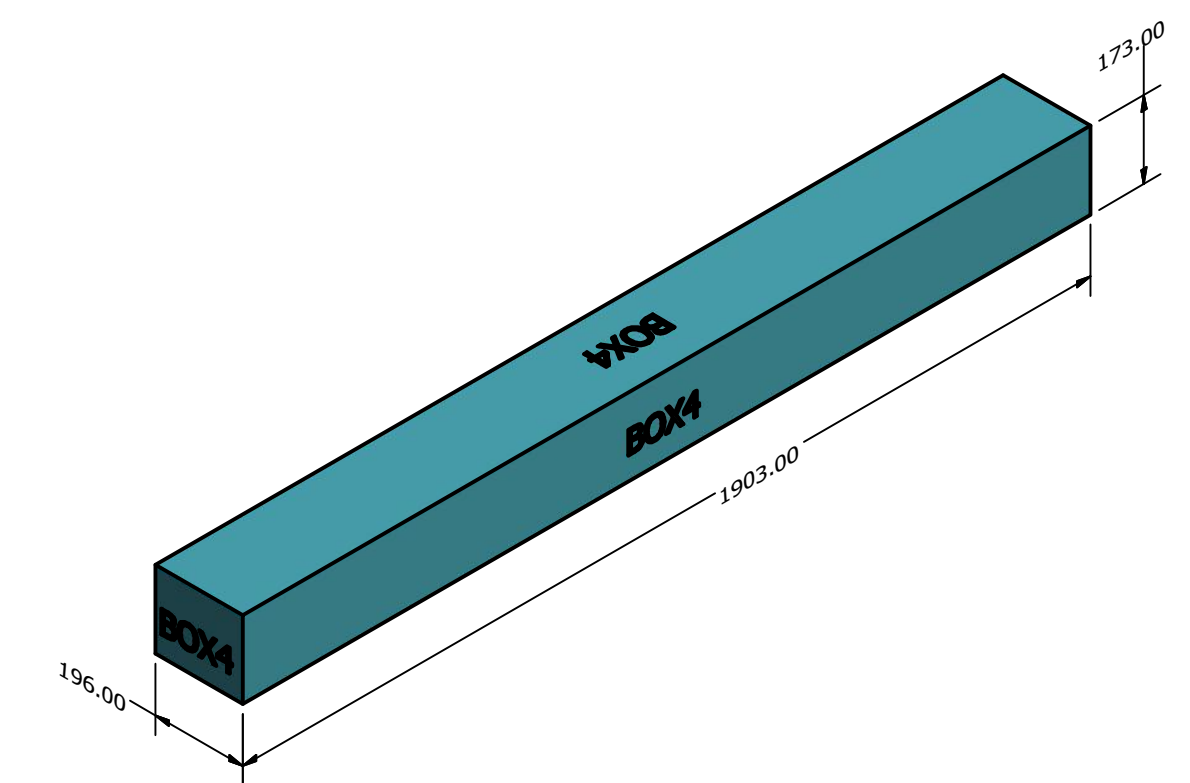

BOX4: 13kg

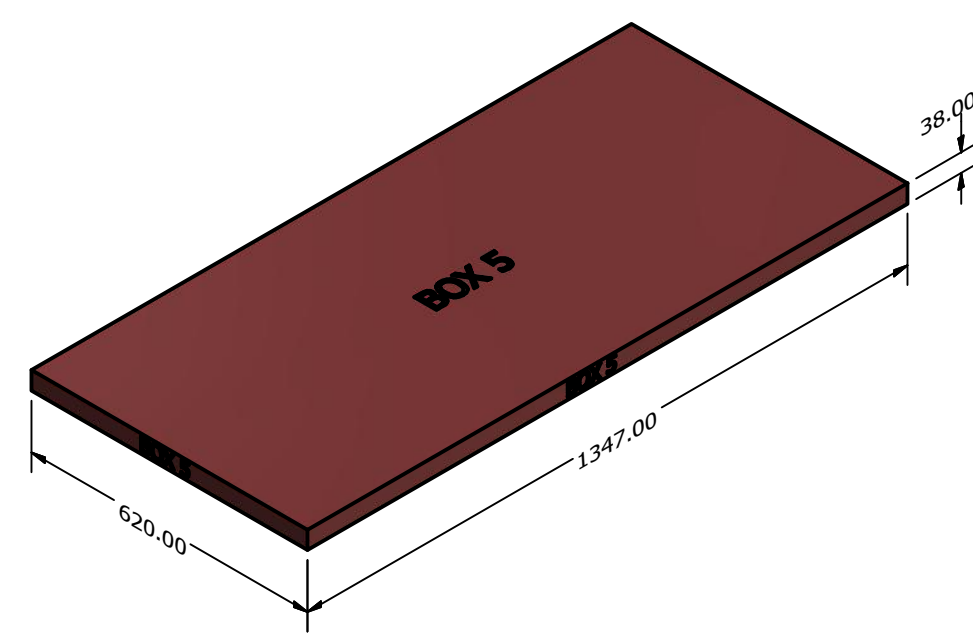

BOX5:21kg

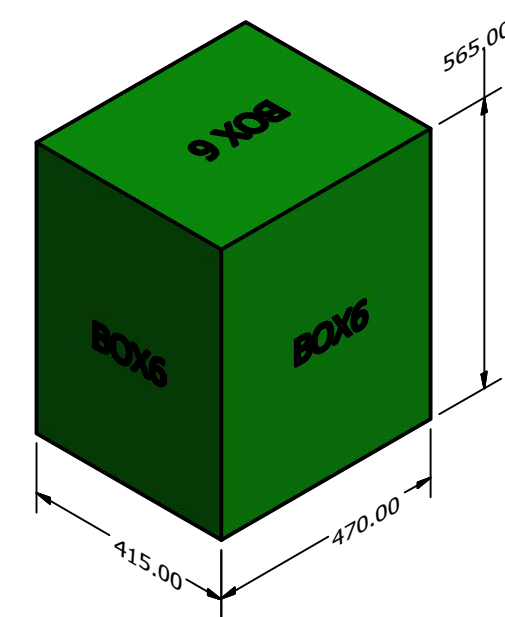

BOX6:20kg

DRAWN				
CHECKED		TITLE		
QA				
MFG				
APPROVED				
		SIZE	DWG NO	REV
		D		
		SCALE	1 / 12	SHEET 1 OF 1