



**ATTENZIONE**

È necessario il montaggio di un adulto.  
Non adatto per bambini sotto i due anni,  
a causa di punti appuntiti e piccole parti.



tempo medio di assemblaggio di 2 persone



il tempo di assemblaggio può variare in base al livello di abilità



**SEMPLICI ISTRUZIONI  
INTERATTIVE PASSO-  
PASSO 3D**



Per la maggior parte fino ad oggi il manuale di montaggio, per registrare il tuo set o per ordinare parti di ricambio si prega di visitare il sito web

**[www.backyarddiscovery.com](http://www.backyarddiscovery.com)**

*Salvare questo assemblaggio manuale per riferimento futuro  
nel caso in cui avete bisogno di ordinare parti di ricambio.*

# INFORMAZIONI SULLA SICUREZZA E SUL MONTAGGIO

LA SCELTA DELLA POSIZIONE CORRETTA PER IL VOSTRO GIOCO È IMPORTANTE PER LA SICUREZZA DEI VOSTRI BAMBINI E LA LONGEVITÀ DEL PRODOTTO

## Dimensioni:

- La Timberlake ha una opzione di layout.

Dimensione della messa a terra  
3'-6" x 3'-10 11/16" x 56" Altezza

Area di gioco sicura\*  
15'-6" x 15'-10 3/4"

\*Superficie del terreno a livello - Vedere sotto

## Informazioni Generali:

Il set è stato progettato e progettato esclusivamente per bambini e solo per uso residenziale.

Un massimo di 150 libbre per ogni bambino è consigliato per le attività ludiche progettate per l'uso individuale.

Un massimo di 120 libbre per ogni bambino è consigliato per le attività ludiche destinate all'uso multiplo.

Per questo set d'oscillazione si raccomanda un massimo di 6 bambini.

## Area di gioco sicura:

- L'area di gioco sicura si riferisce ad una zona che si estende 6' oltre il gioco su tutti i lati, compreso lo spazio sopra il gioco.
- La superficie del terreno deve essere piana. Installare il gioco su un terreno in pendenza può far sì che si inclini o "rompa". L'inclinazione di questo sistema sollecita ulteriormente tutti i collegamenti e le giunzioni e nel tempo causerà l'allentamento e il cedimento di tali collegamenti.
- L'area di gioco sicura deve essere libera da qualsiasi struttura, paesaggio, alberi e rami, rocce, fili e altri ostacoli che impediscano un gioco sicuro. I bambini possono essere gravemente feriti durante la corsa o l'oscillazione in questi ostacoli.
- Rimuovere tutti i pericoli di inciampo dall'area di gioco sicura. I pericoli di inciampo comprendono: radici, ceppi, rocce, elementi da giardinaggio, teste spruzzatrici, legami ferroviari, impianti idraulici e collegamenti elettrici.
- il gioco deve essere installato su terreno solido.

## AREA DI GIOCO SICURA DIAGRAMMA

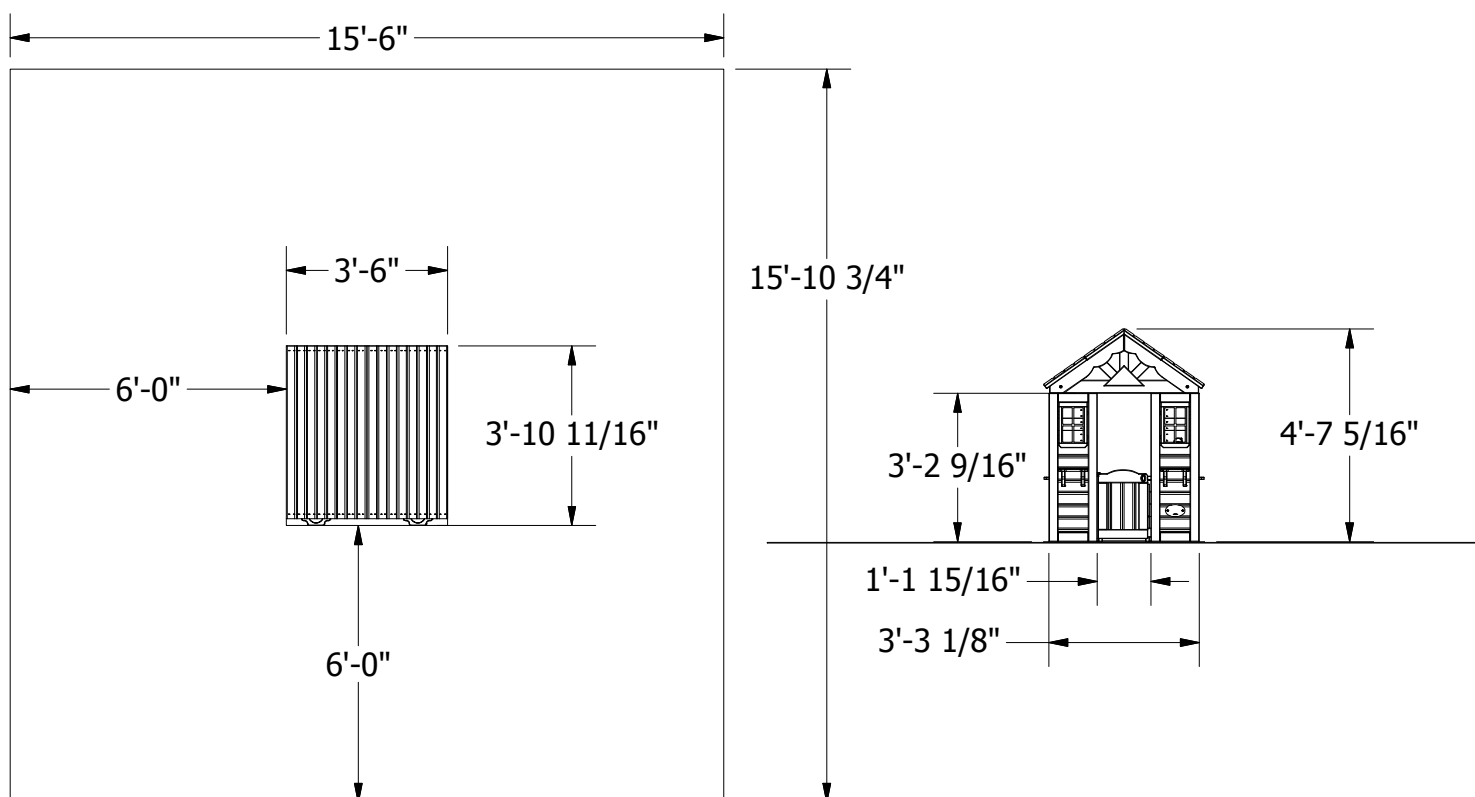

# Identificazione delle Parti

## Componenti in Legno (NON IN SCALA)

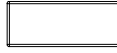

- (1) **J1 - SUPPORTO BANCONE - W4L04753**  
1"x2 3/8"x5 7/8" (24x60x150)

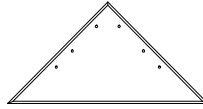

- (2) **K1 - TRIANGOLO SOLARE - W4L04871**  
5/8"x5 1/4"x10 3/8" (16x134x265)

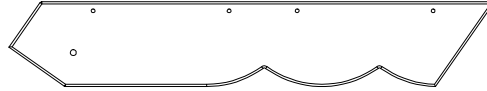

- (4) **L1 - TAVOLA DA MURO - W4L04755**  
5/8"x4 3/8"x25 3/8" (16x112x643)



- (2) **M1 - BANCONE - W4L04754**  
5/8"x3 3/8"x23 5/8" (16x86x600)

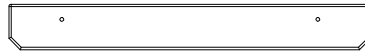

- (2) **N1 - RIPIANO DI FINESTRA LATERALE - W4L04751**  
5/8"x2 3/8"x18 7/8" (16x60x479)



- (1) **N2 - RIPIANO DI FINESTRA POSTERIORE - W4L04760**  
5/8"x2 3/8"x19 1/8" (16x60x485)



- (1) **N3 - FERMO PORTA - W4L04761**  
5/8"x2 3/8"x3 7/8" (16x60x100)



- (8) **N4 - CINTURINO - W102424**  
5/8"x2"x3 1/8" (16x50x80)



- (2) **N5 - GAMBA SOLARE - W4L04872**  
5/8"x2 3/8"x10 1/4" (16x60x260)



- (4) **N6 - GAMBA SOLARE - W4L04873**  
5/8"x2 3/8"x8 1/4" (16x60x210)

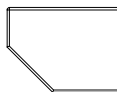

- (1) **Q1 - SUPPORTO BANCONE - W4L04752**  
1"x4 3/8"x5 7/8" (24x112x150)

# Identificazione delle Parti

Componenti in Legno

(NON IN SCALA)

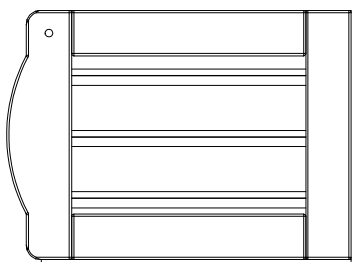

(1) DP1 - ASSEMBLAGGIO  
PORTA - W2A01511

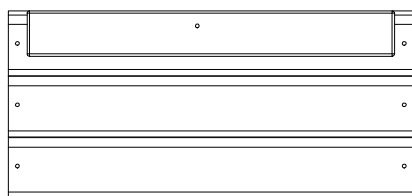

(1) WP7 - PARETE CENTRALE  
POSTERIORE SUPERIORE - W2A01522

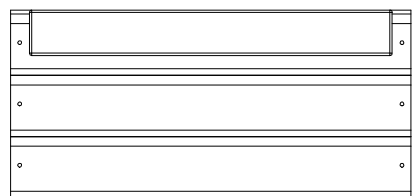

(2) WP6 - PARETE CENTRALE  
SUPERIORE - W2A01510

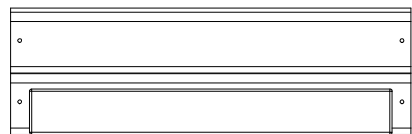

(2) WP5 - PARETE CENTRALE  
INFERIORE - W2A01509

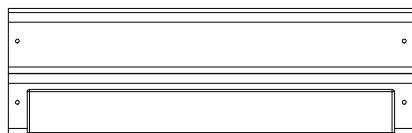

(1) WP8 - PARETE CENTRALE  
POSTERIORE INFERIORE - W2A01523

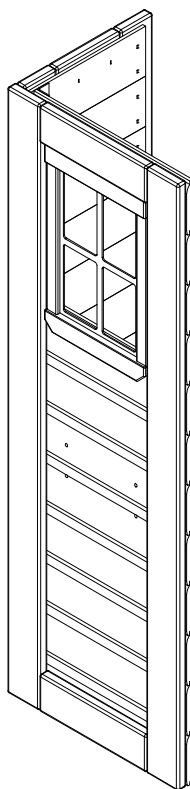

(1) WP1 - PANNELLO ANGOLARE  
ANTERIORE SINISTRA - W2A01524

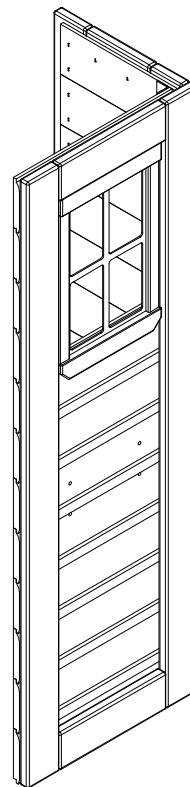

(1) WP2 - PANNELLO ANGOLARE  
ANTERIORE DESTRA - W2A01525

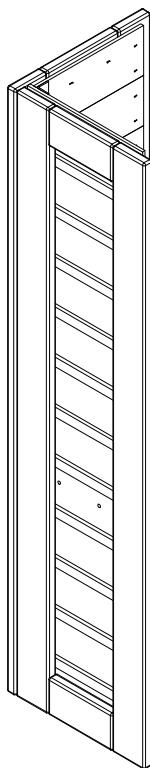

(1) WP3 - PANNELLO ANGOLARE  
POSTERIORE SINISTRA - W2A01526

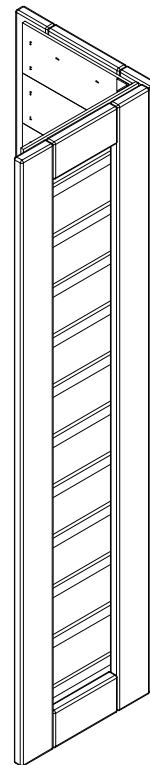

(1) WP4 - PANNELLO ANGOLARE  
POSTERIORE DESTRA - W2A01527

# Identificazione delle Parti

Componenti in Legno

(NON IN SCALA)

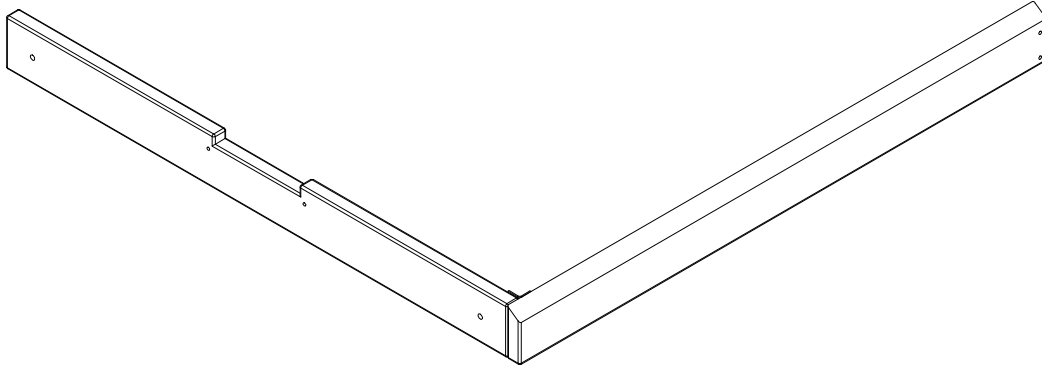

(2) WP9 - ASSEMBLAGGIO TESTATA - W2A01539

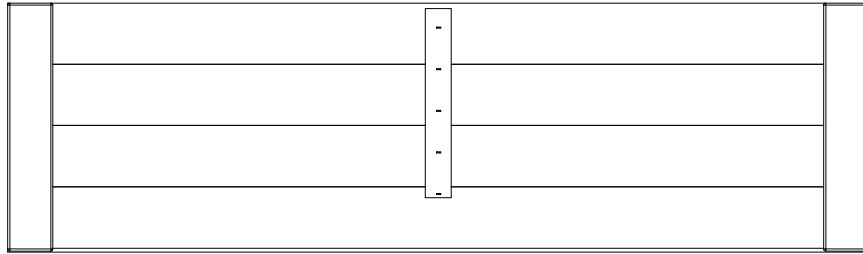

(2) RP1 - PANNELLO DEL TETTO INFERIORE - W2A01513

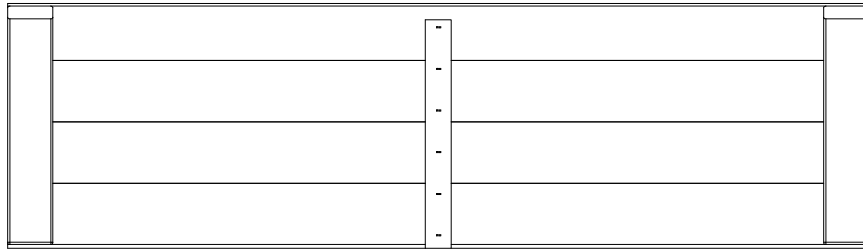

(2) RP2 - PANNELLO DEL TETTO SUPERIORE - W2A01514

# Identificazione delle Parti

## Ferramenteria



(2) VITE PFH 8x1/2 - H100124

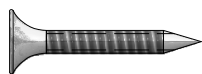

(41) VITE PFH 8x1 - H100085



(33) VITE PFH 8x1 1/8 - H100088



(51) VITE PFH 8x1 1/4 - H100087



(24) VITE PFH 8x1 1/2 - H100086



(1) VITE PFH 8x2 - H100111

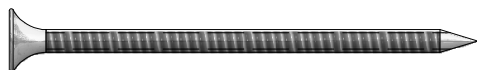

(4) VITE PFH 8x2 1/2 - H100090

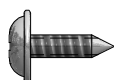

(2) VITE PWH 8x7/16 - H100361

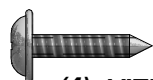

(4) VITE PWH 8x5/8 - H100128



(9) VITE PWH 8x3/4 - H100070

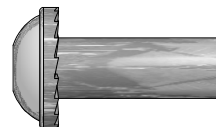

(4) BULLONE WH 1/4x7/8 - H100140

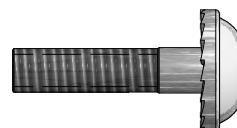

(4) BULLONE WH 1/4x1 - H100137

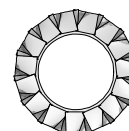

(4) RONDELLA DI BLOCCAGGIO EXT 8x15 - H100139

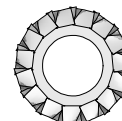

(4) RONDELLA DI BLOCCAGGIO 6x15 - H100138

9220119 | Kit di Strumenti  
(1)

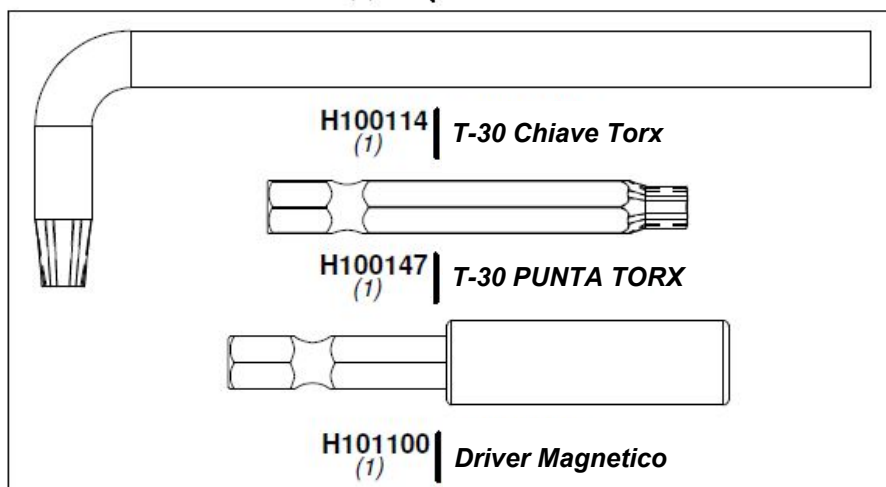

# Identificazione delle Parti

Accessori  
(NON IN SCALA)

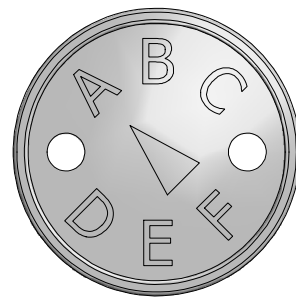
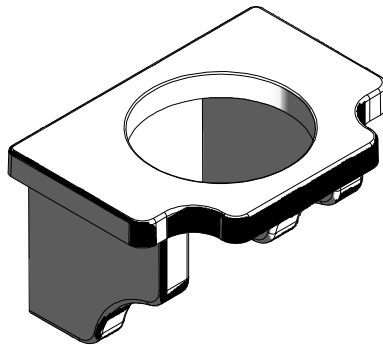

(1) KIT PER TELEFONO - A100132 (2) PORTA VASO DA FIORI - A6P00023 (1) TARGETTA "A" REVISIONE - A100314

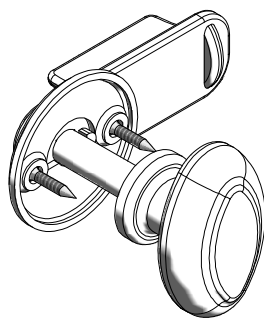

(1) KID DEL POMELLO - A6P00020

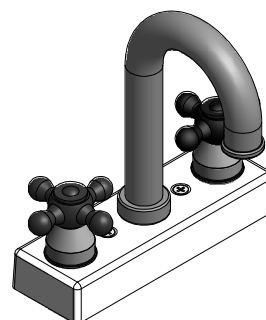

(1) KIT DEL RUBINETTO - A6P00024

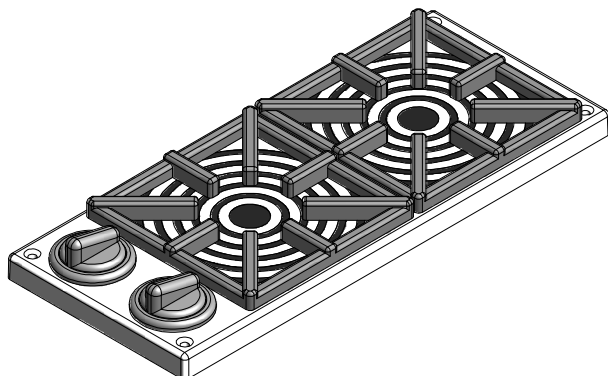

(1) KIT FORNELLI - A6P00025



(1) BYD TARGETTA ID (MEDIA) ETA' DA 2 A 10 - A4M00528

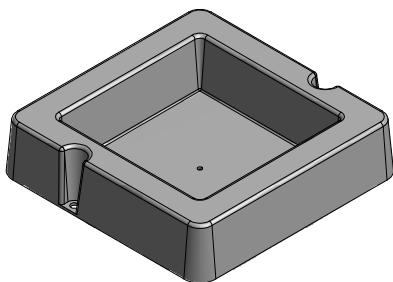

(1) VASCA DI MONTAGGIO DELLA SUPERFICIE - A6P00032

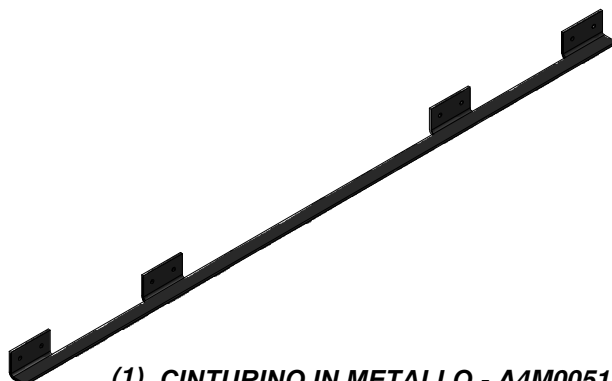

(1) CINTURINO IN METALLO - A4M00517

# FASE DI PRE-ASSEMBLAGGIO 1 - ORDINAMENTO DELLE PARTI

È fondamentale per facilitare il montaggio dedicare del tempo a ordinare e organizzare il legno e l'hardware.

---

## PARTI IN LEGNO:

- Organizzare le parti in legno in base al numero alfanumerico a tre cifre stampato su ogni scheda (es. P01).
- Se ci sono più schede con lo stesso numero timbrato, impilare questi pezzi insieme.
- I timbri possono essere trovati sulla superficie piana delle tavole o sull'estremità delle tavole.
- Concediti molto spazio: i pezzi di legno possono occupare una notevole quantità di spazio.

**NOTA: I CARTONI NON SONO ORGANIZZATI PER NUMERO DI SCHEDA.**

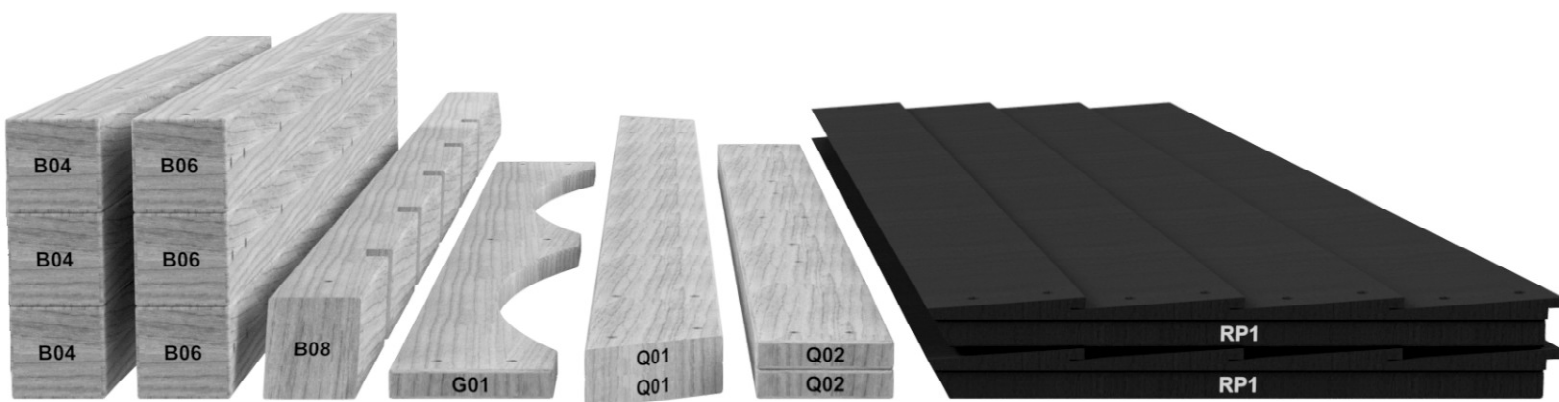

## PARTI HARDWARE:

- Si consiglia di avere una tabella separata per organizzare l'hardware.
- I sacchetti di ferramenta sono stampati con un codice alfanumerico di sette cifre.
- È possibile organizzare l'hardware per numero di parte o raggruppare per tipo di hardware (ad esempio bulloni, dadi, ecc.).
- Durante il montaggio è sufficiente fare riferimento alle ultime quattro cifre del numero.

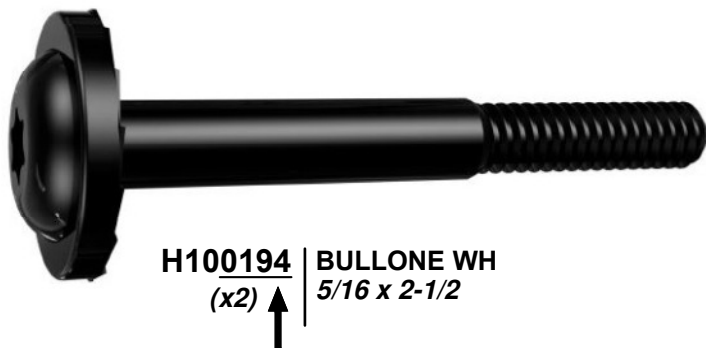

# FASE DI PRE-ASSEMBLAGGIO 2 - UTENSILI NECESSARI



**Trapano a  
Batteria o  
Trapano  
Elettrico**



**Accessori per  
trapano: Phillips  
Head**



**Punte da 1/8", 3/16",  
3/8" e 7/16"**



**Cacciavite Phillips**



**Chiavi aperte 1/2" & 9/16"**



**Cricchetto unità da 3/8", 1/2" e  
Prese STD da 9/16" 1/2" e prese  
profonde da 9/16"**

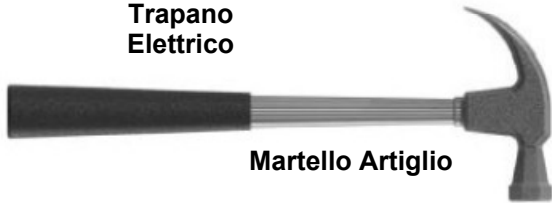

**Martello Artiglio**



**Mazzo di Gomma - Opzionale**



**Metro a Nastro**

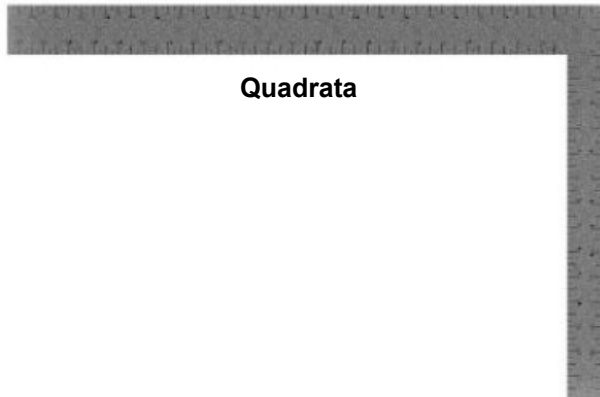

**Quadrata**



**Livello 24"**

# FASE DI PRE-ASSEMBLAGGIO 3 - SCEGLI IL TUO METODO DI ASSEMBLAGGIO

Sono disponibili diversi tipi di istruzioni di montaggio.

1. Manuale di montaggio stampato incluso nel set
2. BILT APP - istruzioni interattive 3D
3. Combinazione del manuale stampato e dell'APP BILT (Nota: i numeri di passo possono differire tra i due metodi)



## Scan for easy 3D instructions

Download the BILT app  
before you begin

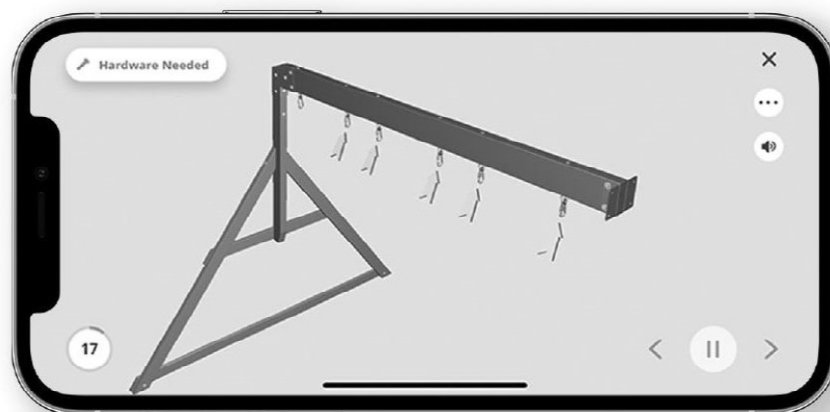

# Assemblaggio Casa Giocattolo

## **PASSO 1:**

ALZA I 4 GRUPPI ANGOLARI A PARETE COME MOSTRATO DI SEGUITO.

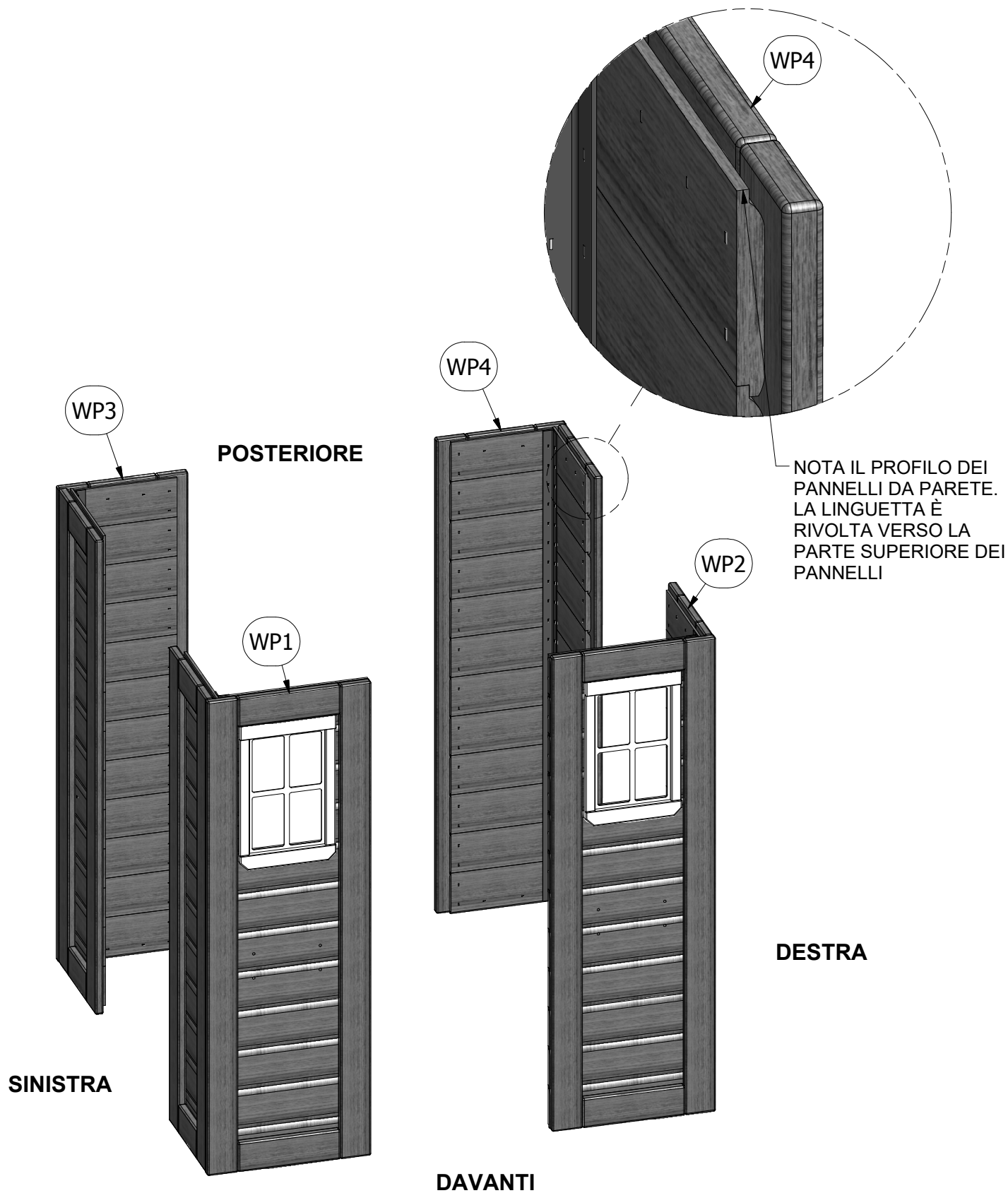

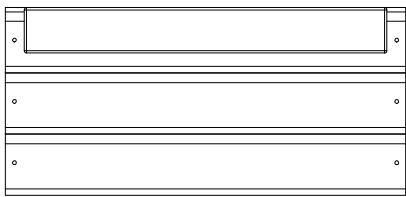

(1) WP6 - PARETE CENTRALE SUPERIORE - W2A01510

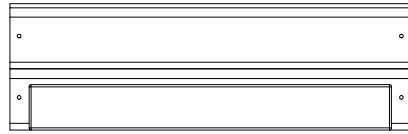

(1) WP5 - PARETE CENTRALE INFERIORE - W2A01509

**PASSO 2:**

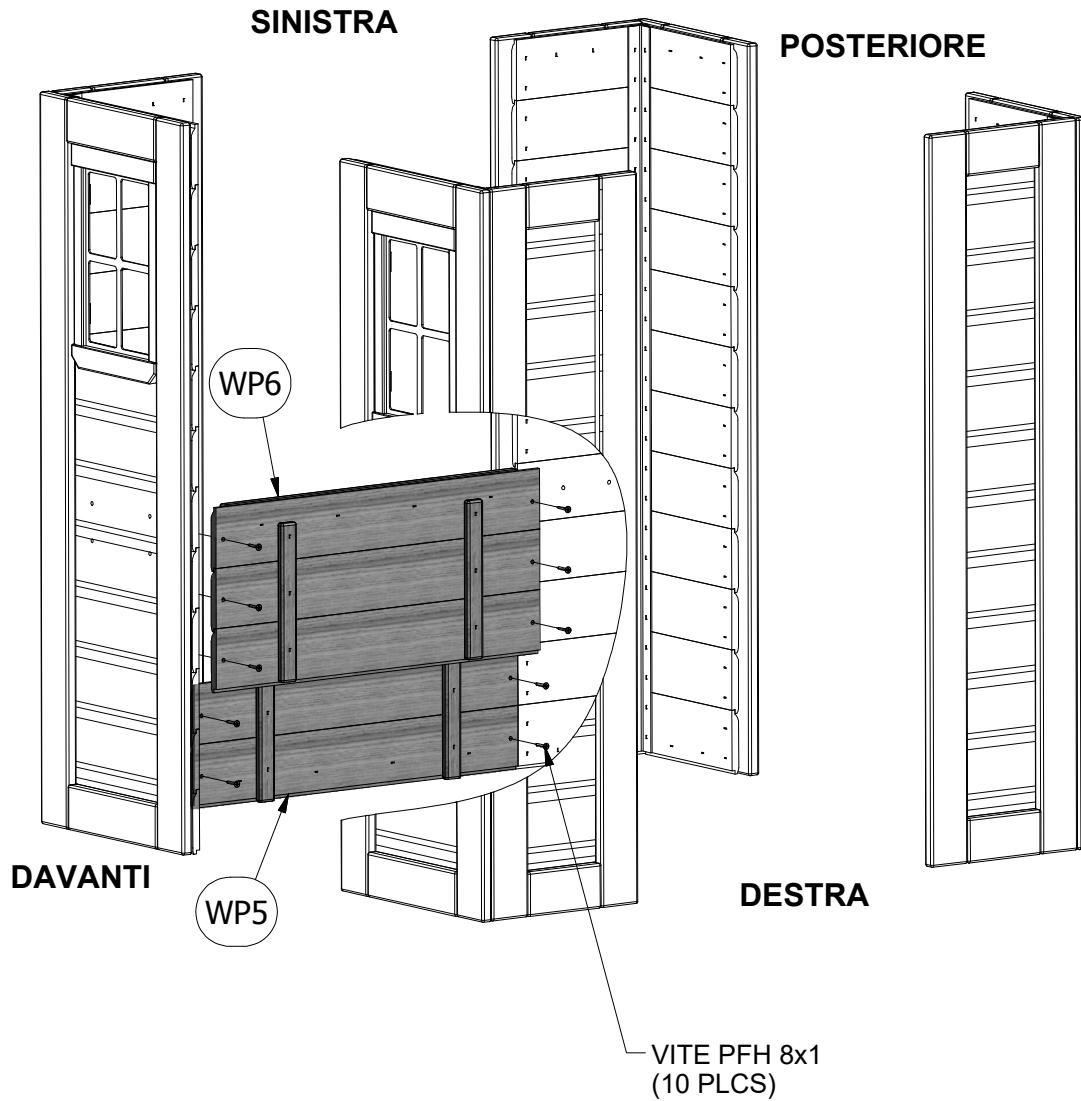
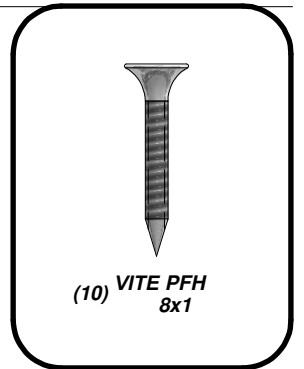

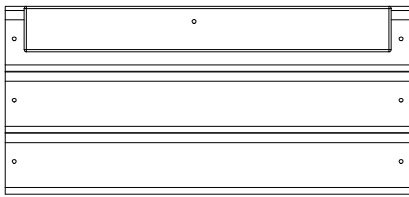

(1) WP7 - PARETE CENTRALE  
POSTERIORE SUPERIORE - W2A01522

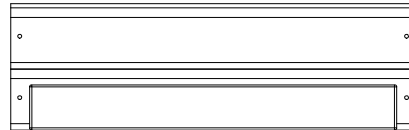

(1) WP8 - PARETE CENTRALE  
POSTERIORE INFERIORE - W2A01523

**PASSO 3:**

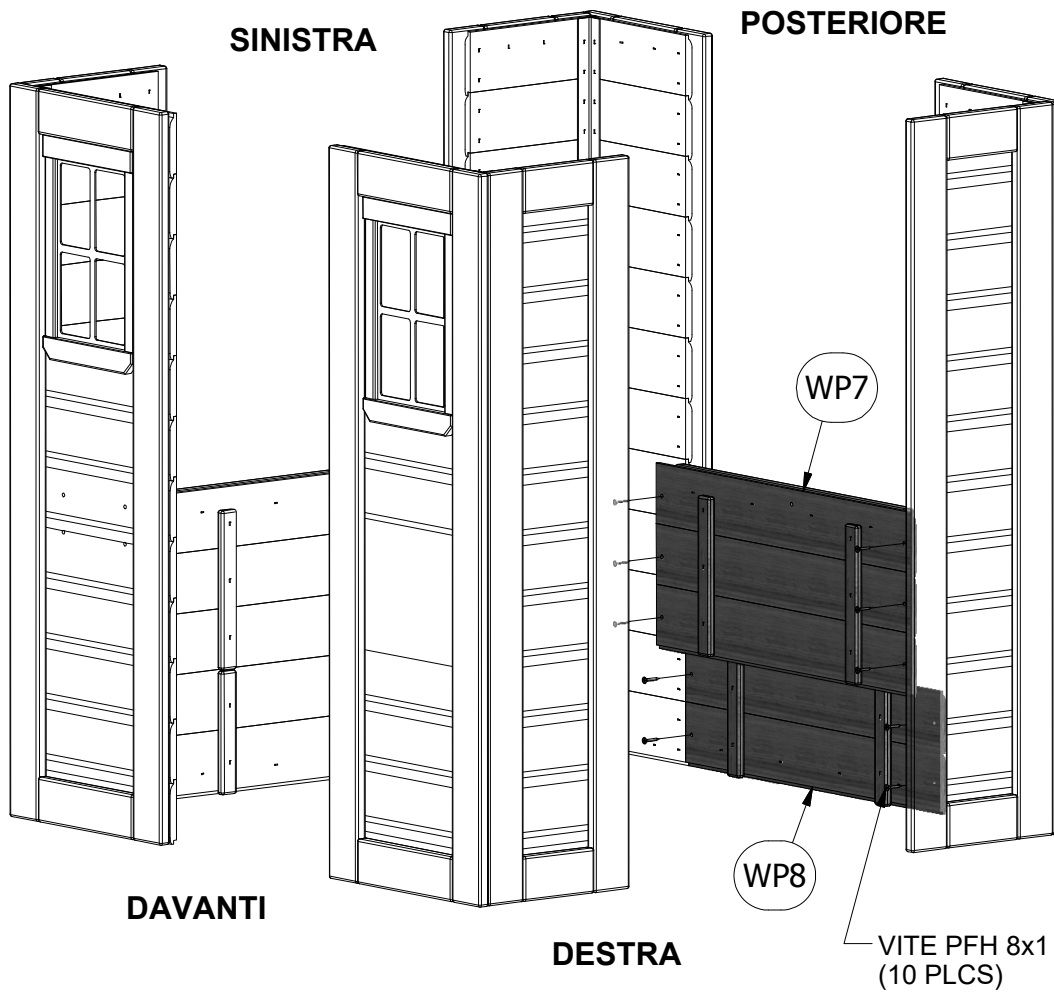
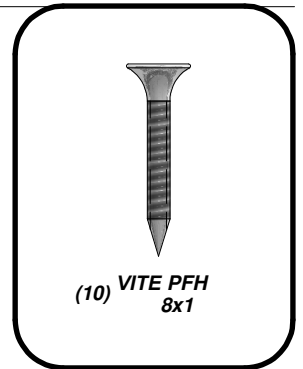

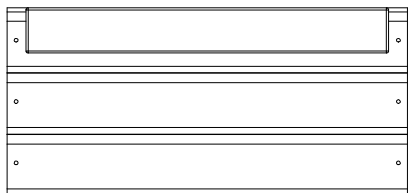

(1) WP6 - PARETE CENTRALE SUPERIORE - W2A01510

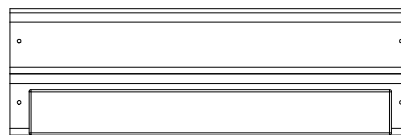

(1) WP5 - PARETE CENTRALE INFERIORE - W2A01509

**PASSO 4:**

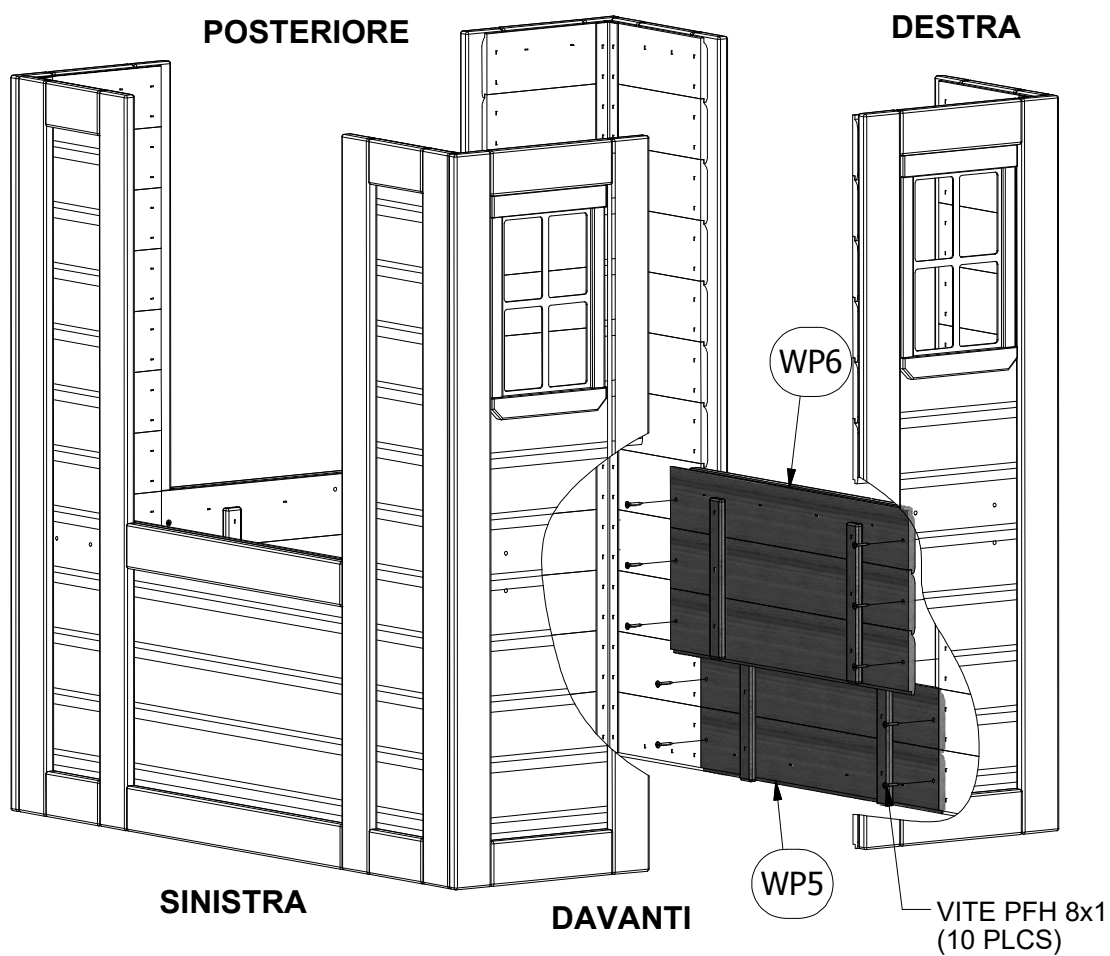
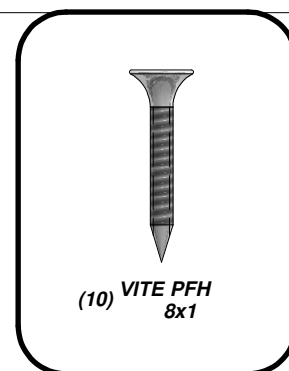

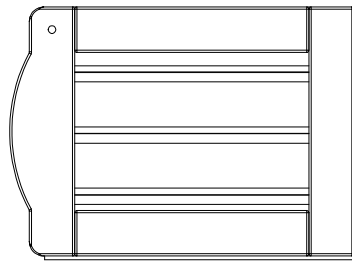

(1) DP1 -ASSEMBLAGGIO PORTA - W2A01511

**PASSO 5:**

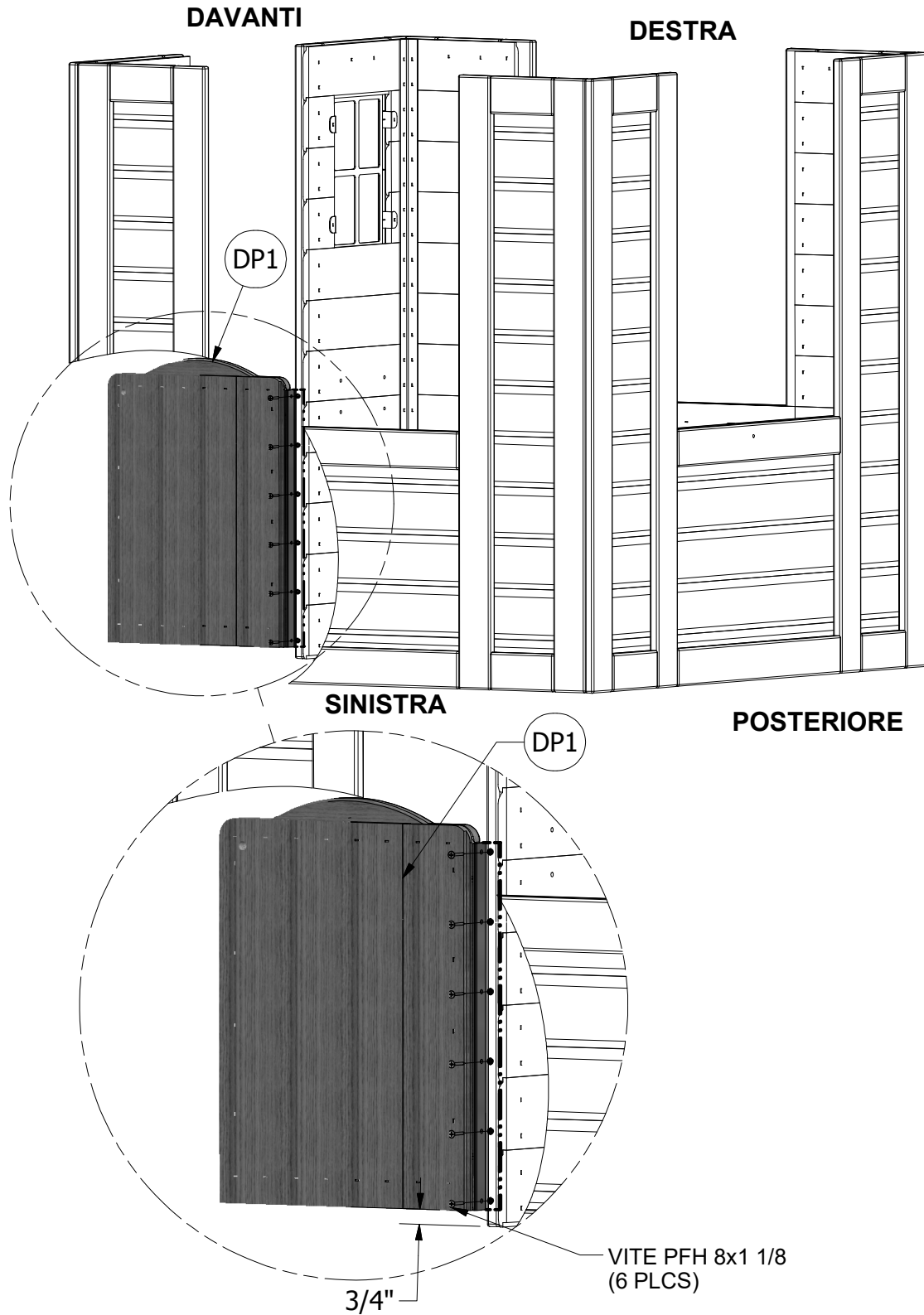
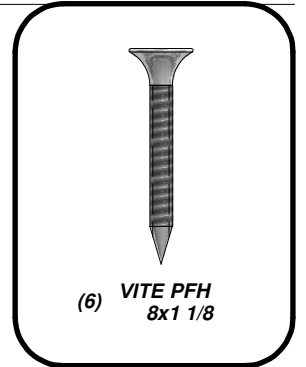



(1) CINTURINO IN METALLO - A4M00517

PASSO 6:

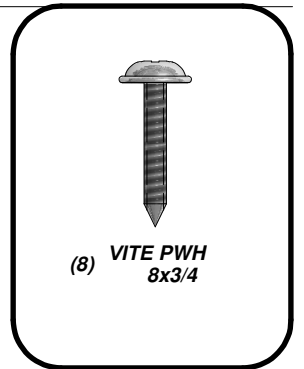

(8) VITE PWH  
8x3/4

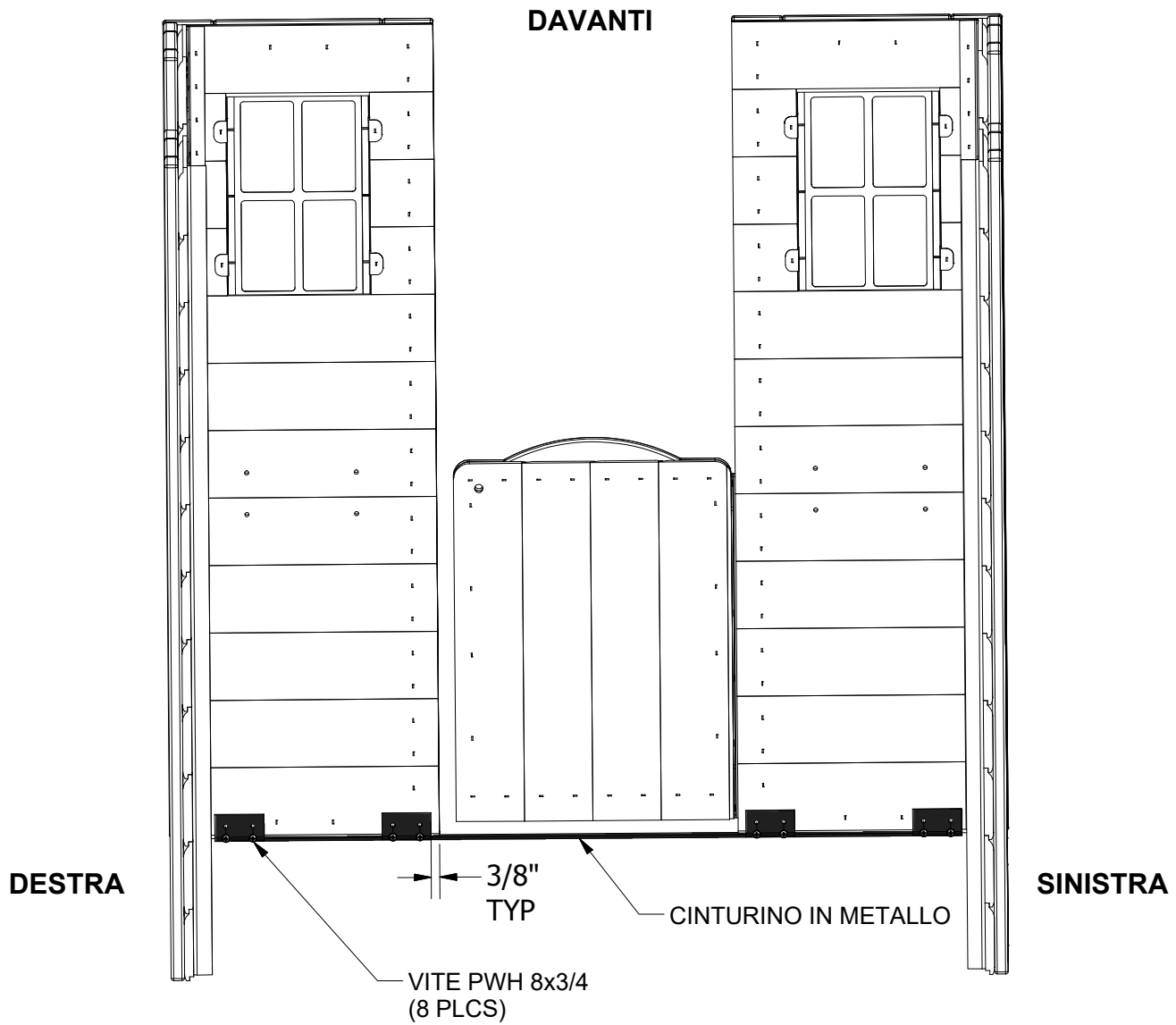

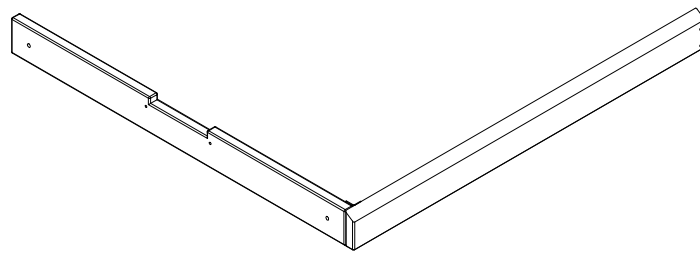

(2) WP9 - ASSEMBLAGGIO TESTATA - W2A01512

**PASSO 7:**

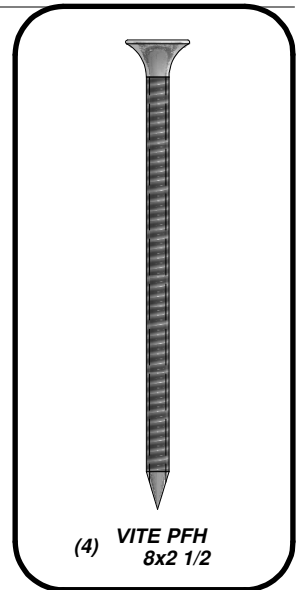
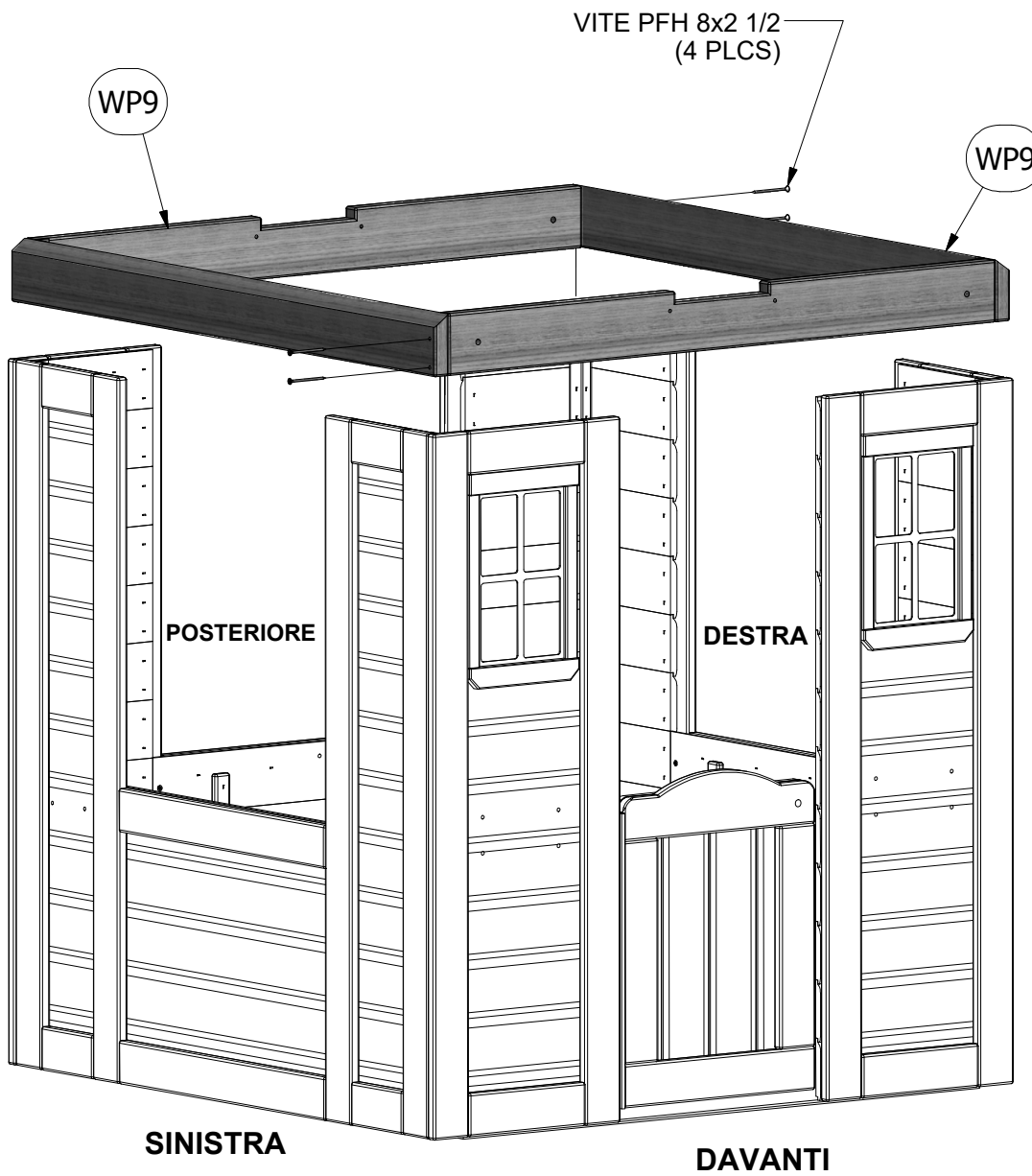

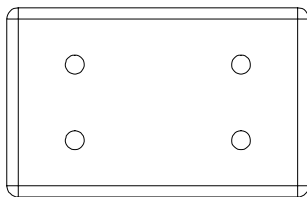

**N4 - CINTURINO - W102424**  
**(8) 5/8"x2"x3 1/8" (16x50x80)**

**PASSO 8:**

VITE PFH 8x1 1/4  
(32 PLCS)

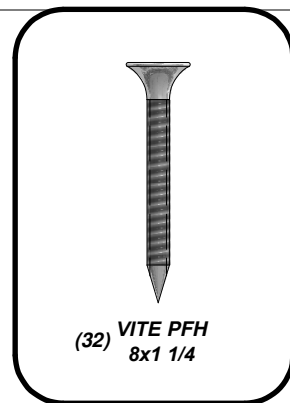
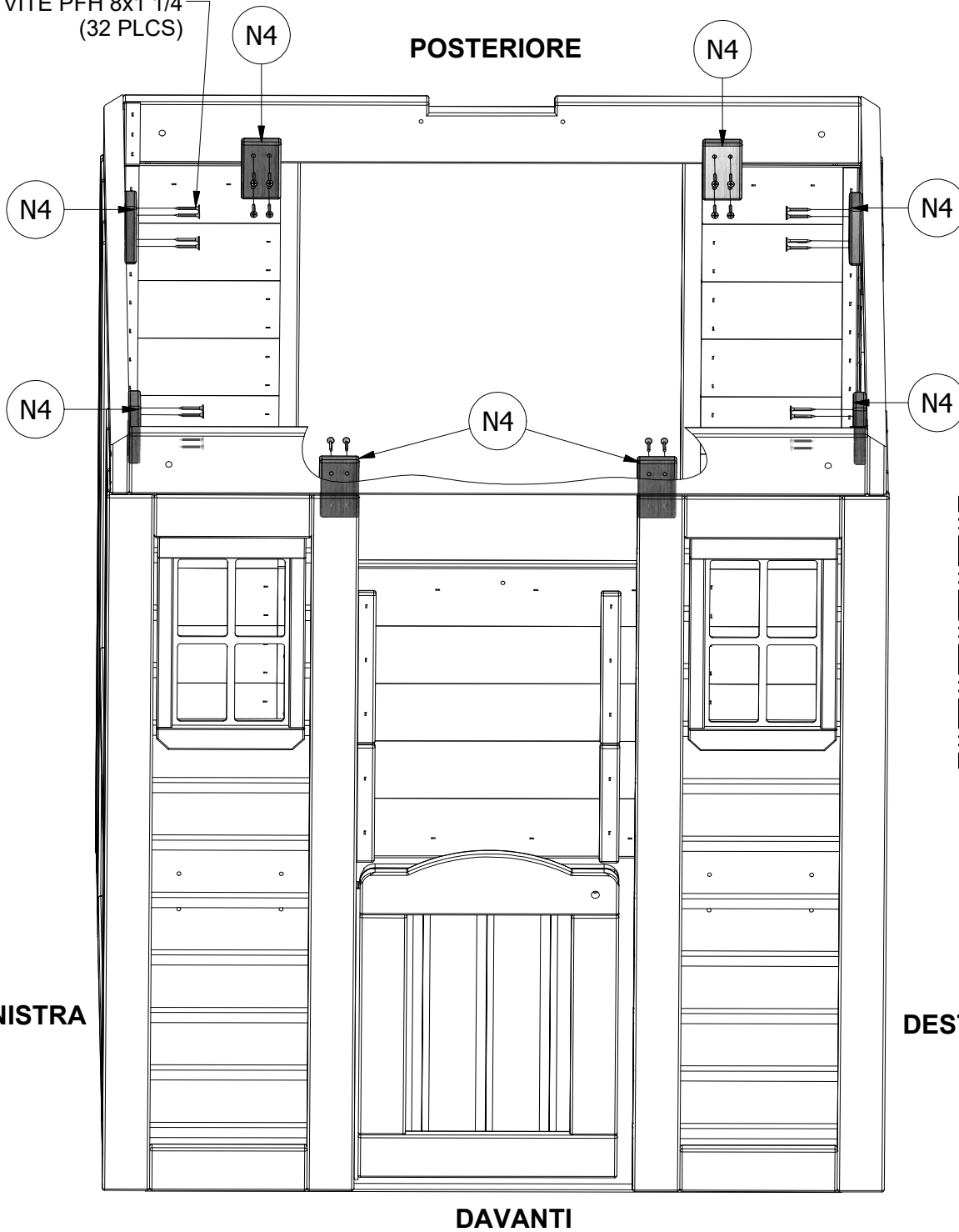

**(32) VITE PFH**  
**8x1 1/4**

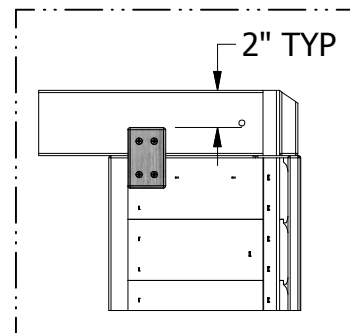

**SINISTRA**

**DESTRA**

**DAVANTI**



**L1 - TAVOLA DA MURO - W4L04755**  
**(4) 5/8"x4 3/8"x25 3/8" (16x112x643)**

**PASSO 9:**

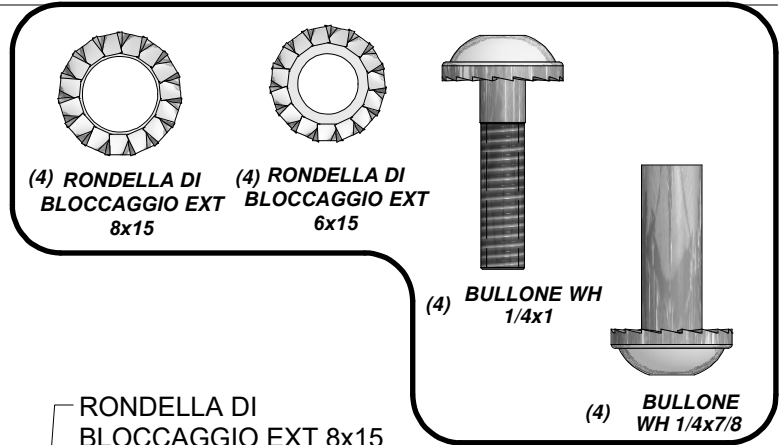

RONDELLA DI BLOCCAGGIO EXT 6x15 (4 PLCS)

BULLONE WH 1/4x1 (4 PLCS)

L1

L1

RONDELLA DI BLOCCAGGIO EXT 8x15 (4 PLCS)

BULLONE WH 1/4x7/8 (4 PLCS)

L1

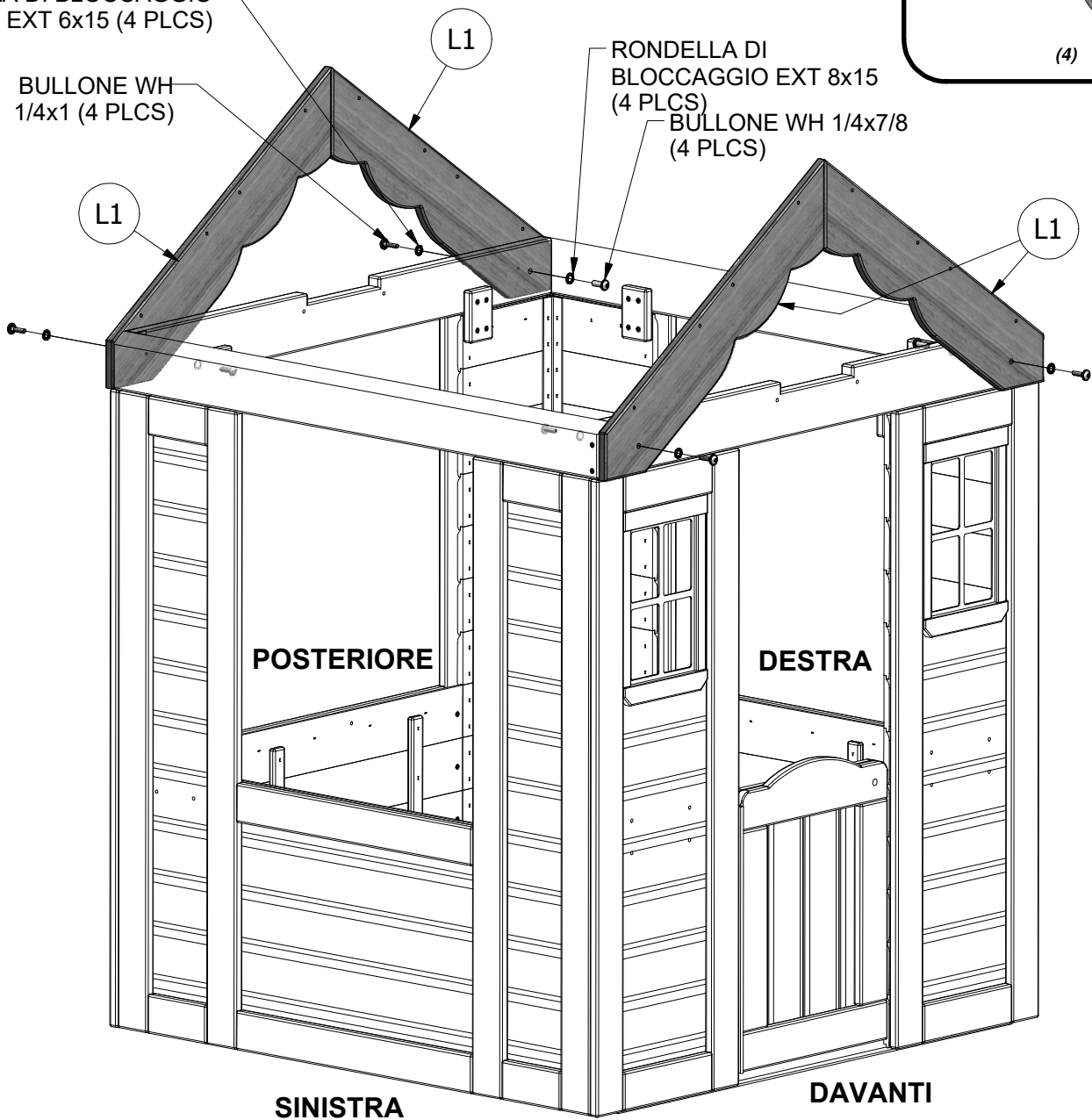

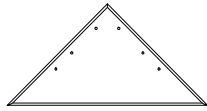

- (2) **K1 - TRIANGOLO SOLARE - W4L04871**  
5/8"x5 1/4"x10 3/8" (16x134x265)



- (2) **N5 - GAMBA SOLARE - W4L04872**  
5/8"x2 3/8"x10 1/4" (16x60x260)



- (4) **N6 - GAMBA SOLARE - W4L04873**  
5/8"x2 3/8"x8 1/4" (16x60x210)

**PASSO 10:**

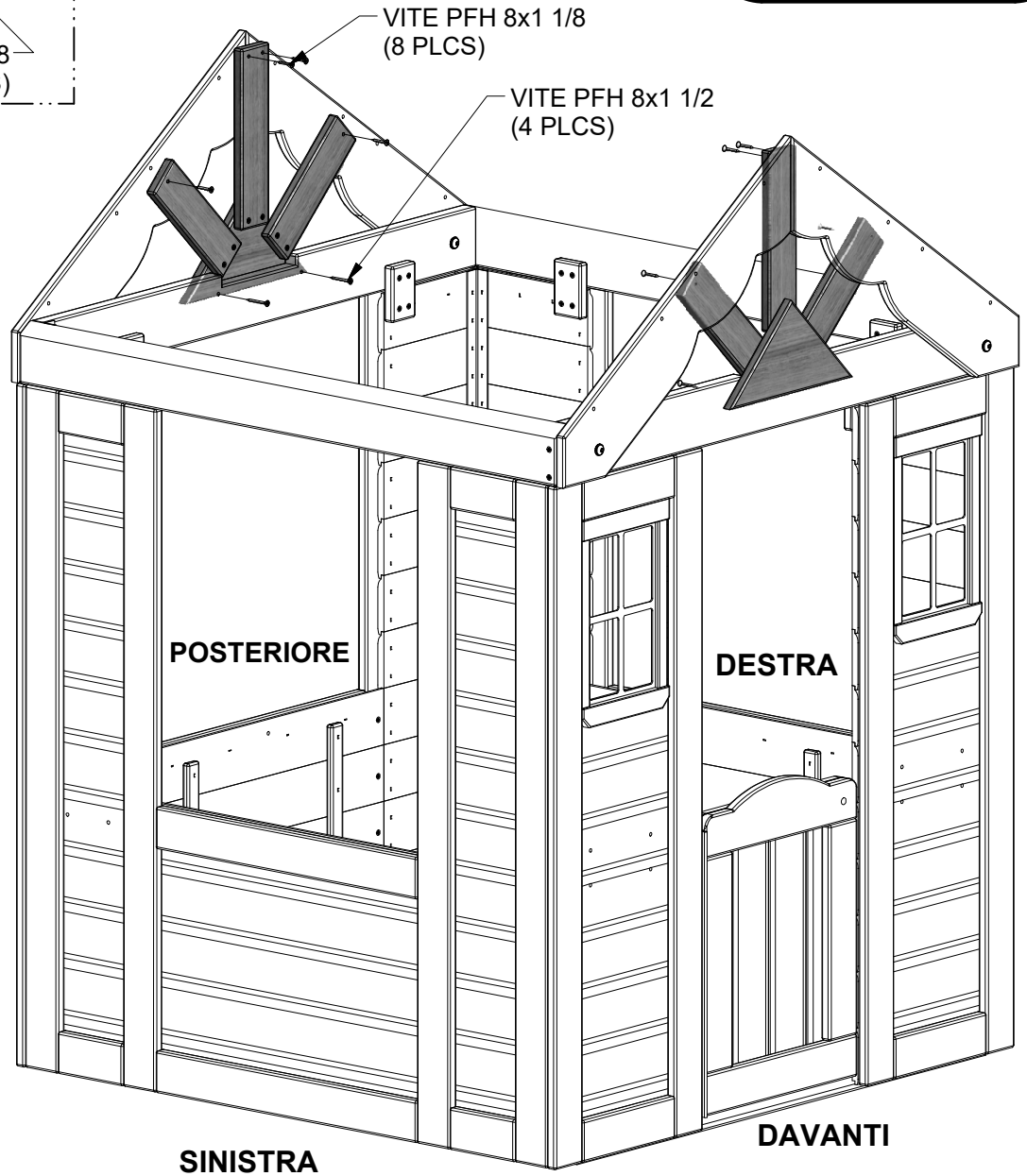
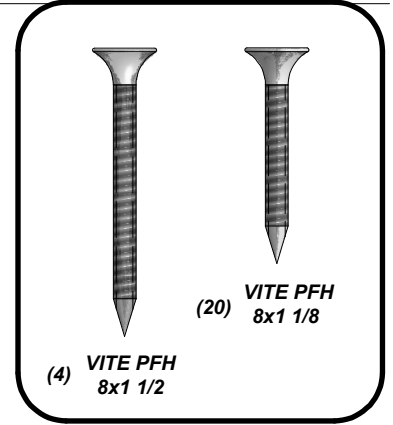
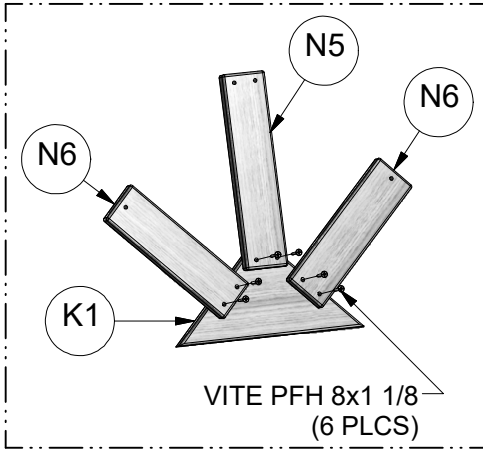

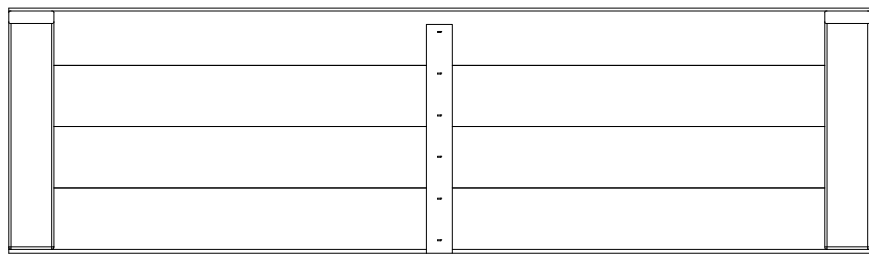

(2) RP2 - PANNELLO DEL TETTO SUPERIORE - W2A01514

**PASSO 11:**

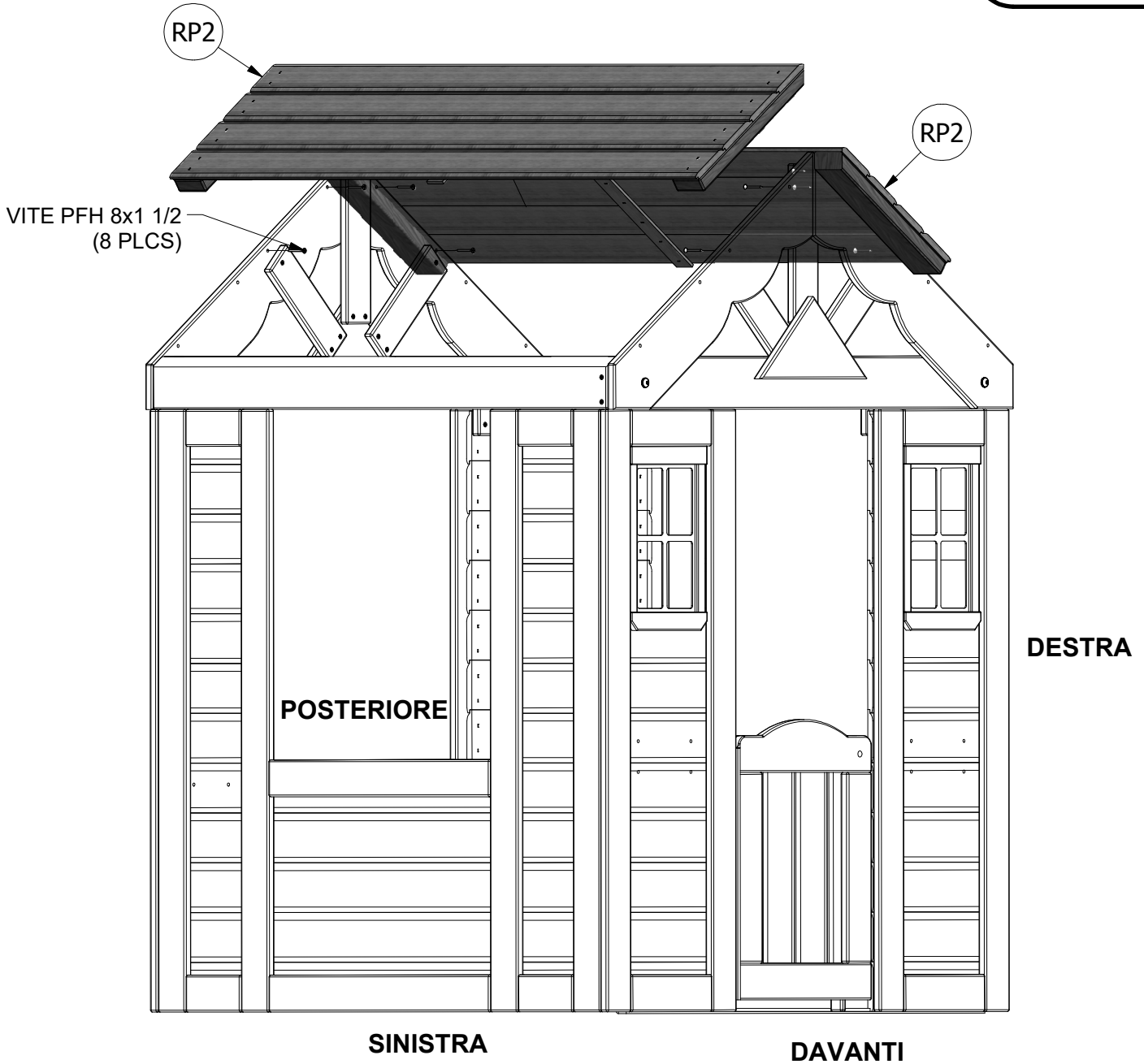
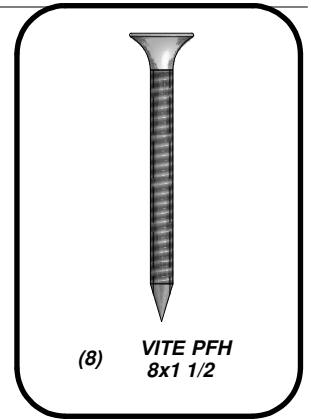
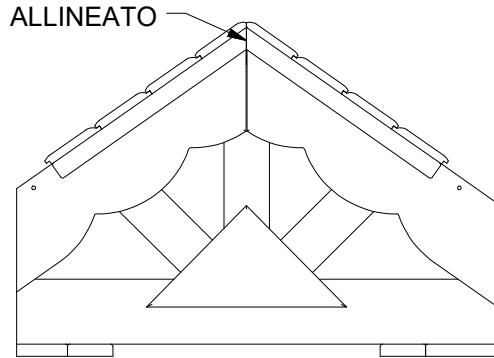

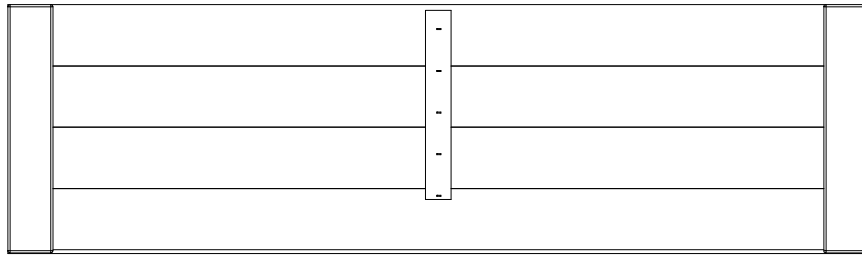

(2) RP1 - PANNELLO DEL TETTO INFERIORE- W2A01513

**PASSO 12:**

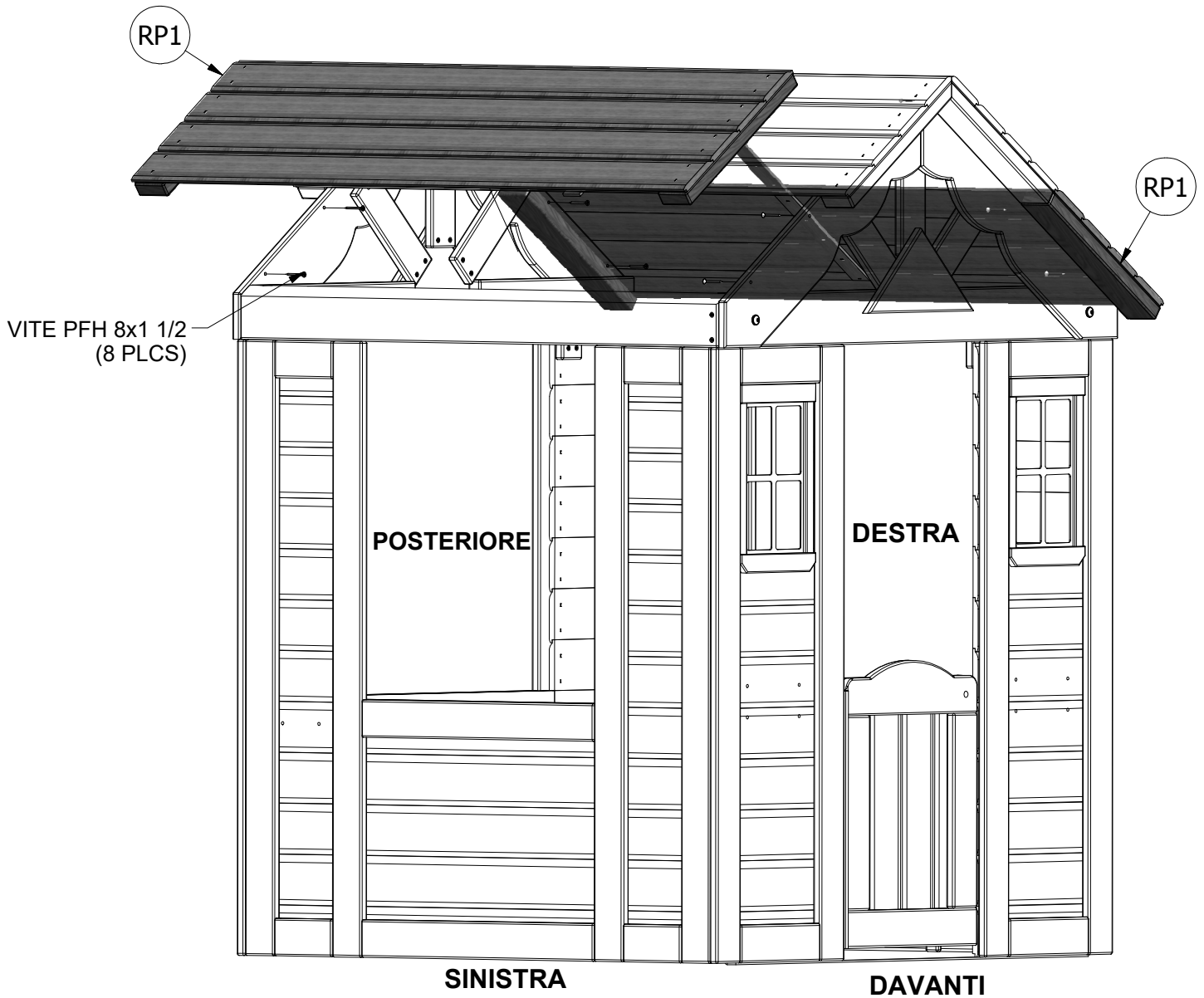
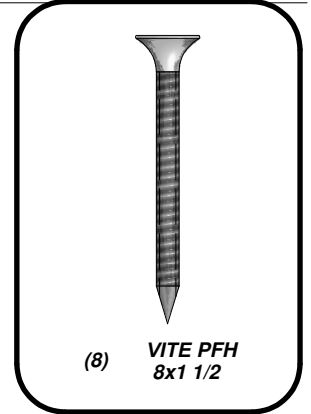

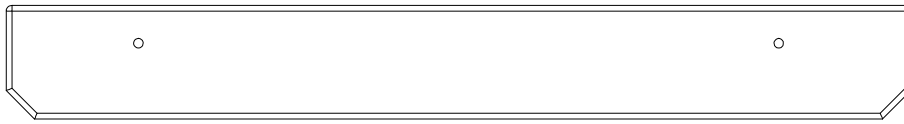

(1) **N1 - RIPIANO DI FINESTRA LATERALE - W4L04751**  
**5/8"x2 3/8"x18 7/8" (16x60x479)**

**PASSO 13:**

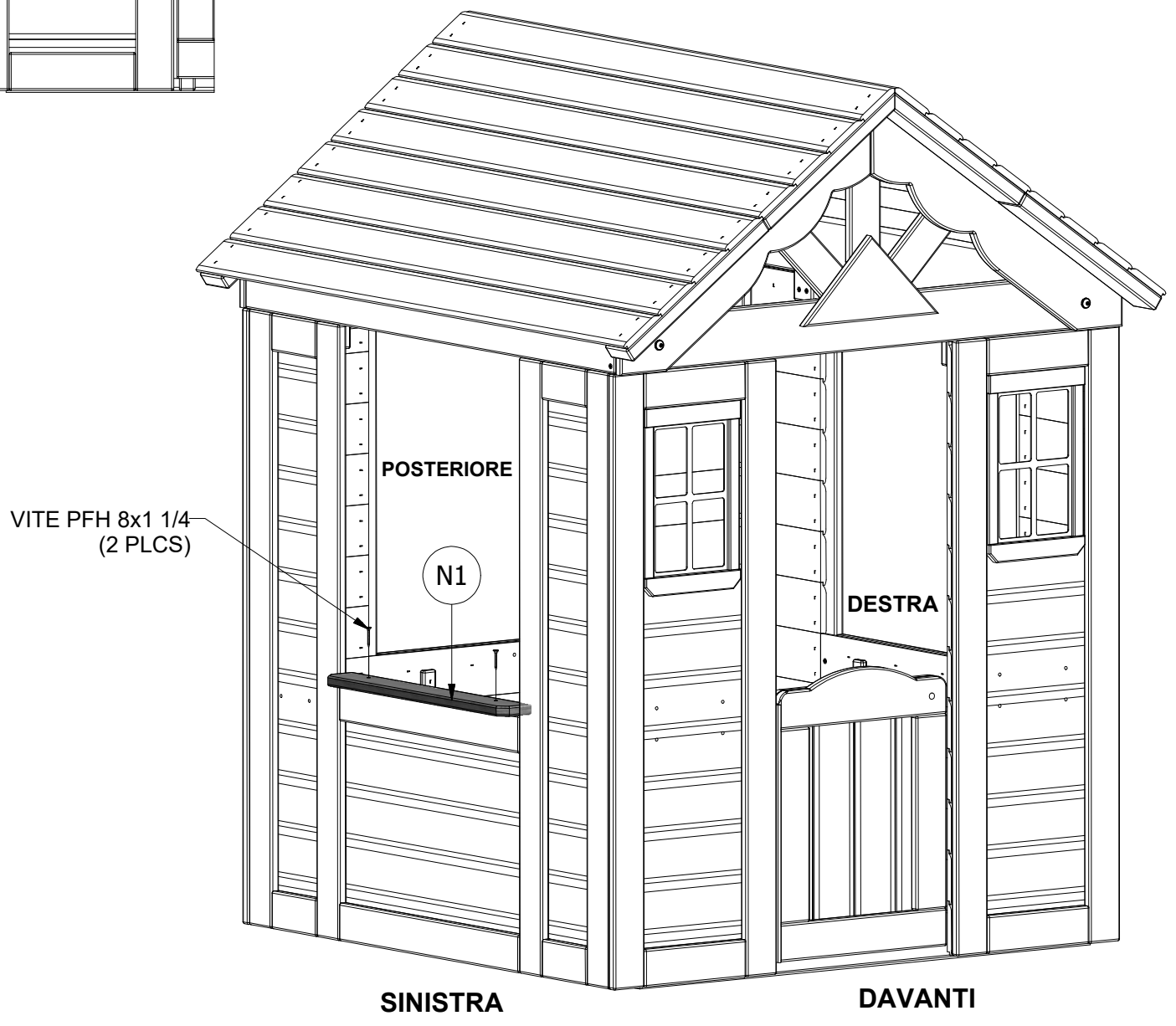
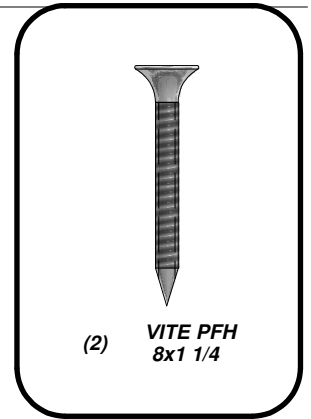
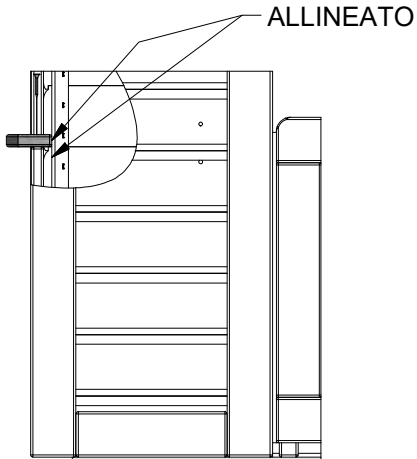

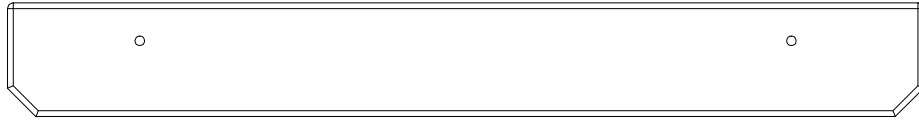

(1) **N2 - RIPIANO DI FINESTRA POSTERIORE - W4L04760**  
5/8"x2 3/8"x19 1/8" (16x60x485)

**PASSO 14:**

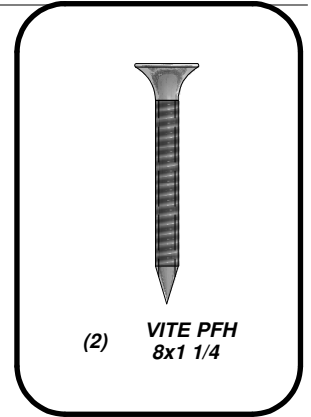
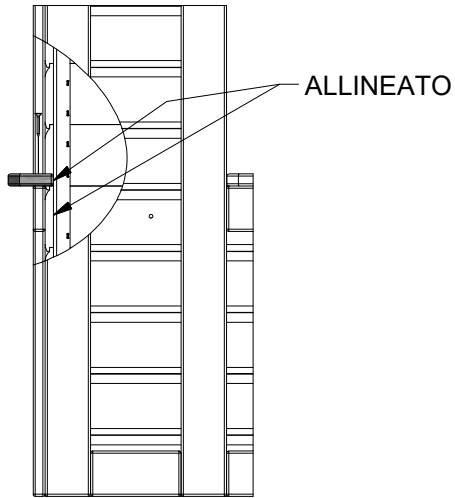

VITE PFH 8x1 1/4  
(2 PLCS)

DESTRA

N2

POSTERIORE

SINISTRA

DAVANTI

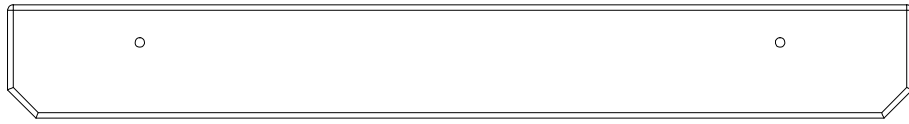

(1) **N1 - RIPIANO DI FINESTRA LATERALE - W4L04751**  
5/8"x2 3/8"x18 7/8" (16x60x479)

**PASSO 15:**

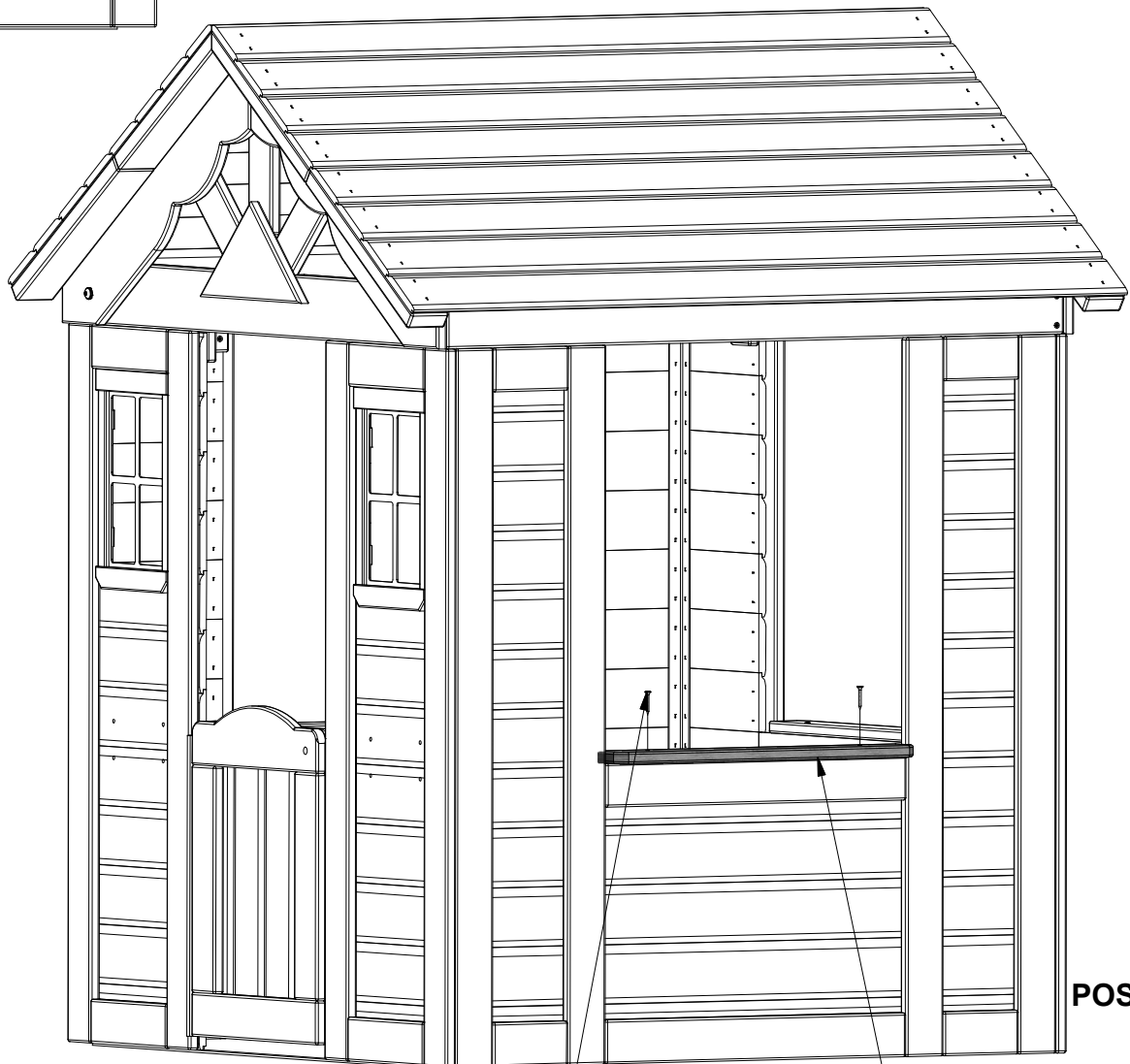
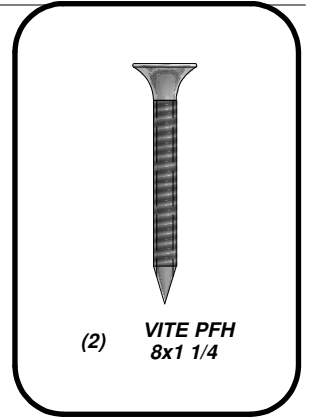
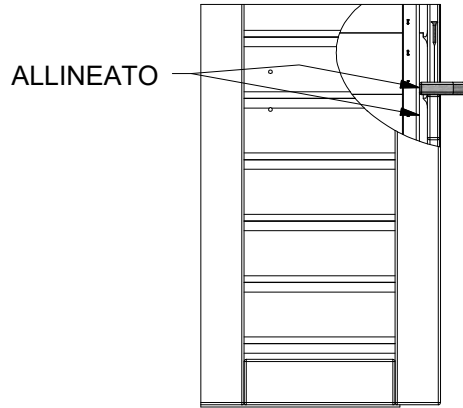

**DAVANTI**

**DESTRÀ**

**POSTERIORE**

VITE PFH 8x1 1/4  
(2 PLCS)

**N1**

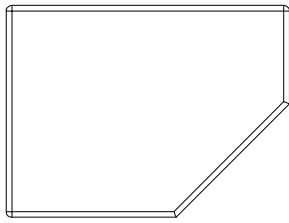

(1) **Q1 - SUPPORTO BANCONE - W4L04752**  
**1"x4 3/8"x5 7/8" (24x112x150)**

**PASSO 16:**

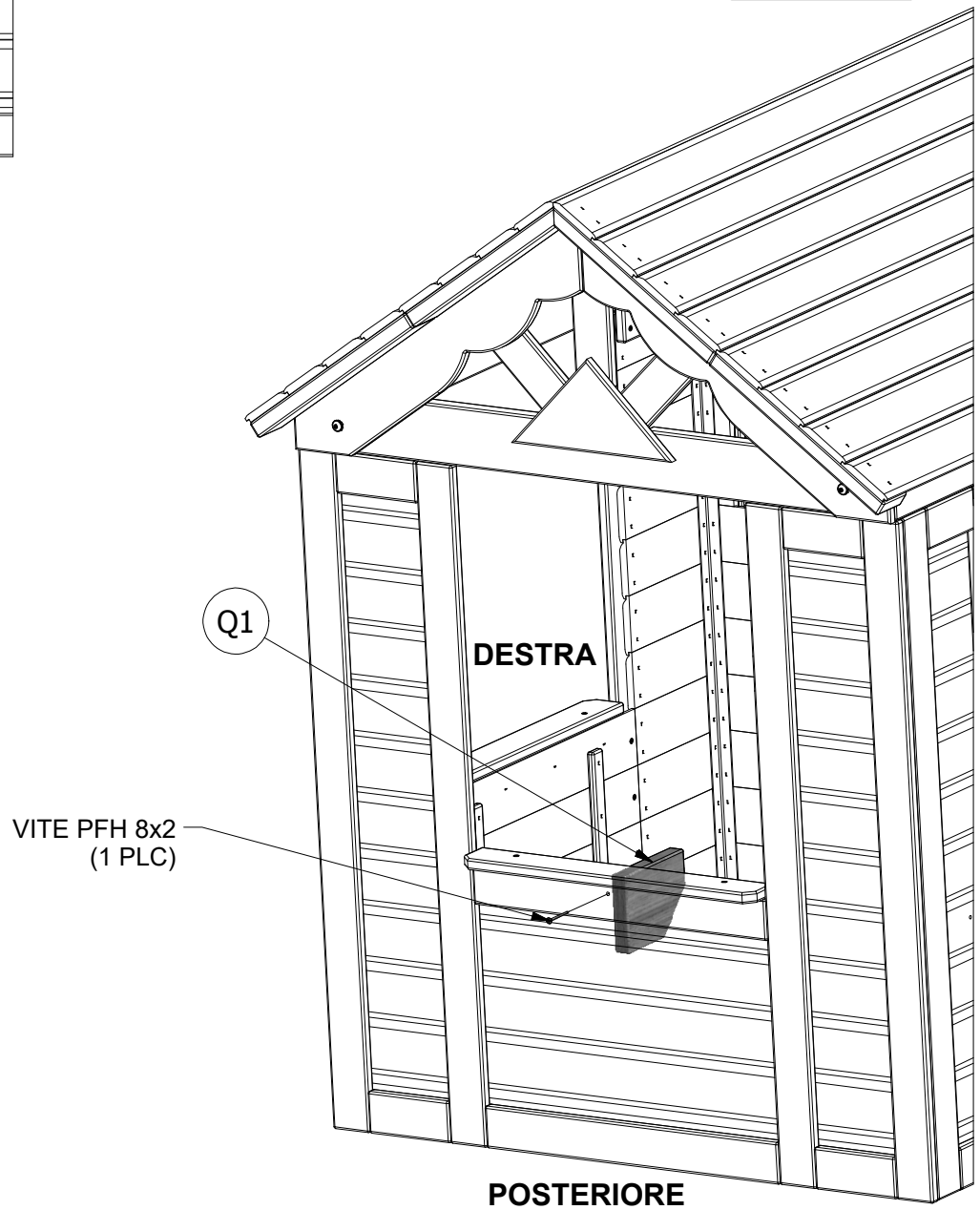
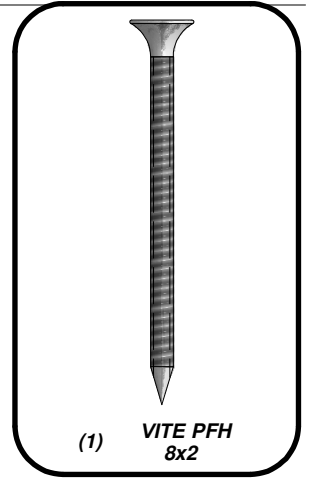
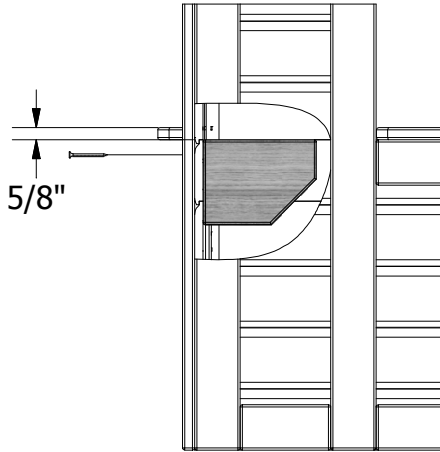

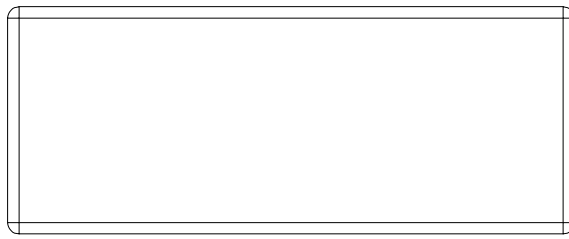

(1) **J1 - SUPPORTO BANCONE - W4L04753**  
1"x2 3/8"x5 7/8" (24x60x150)

**PASSO 17:**

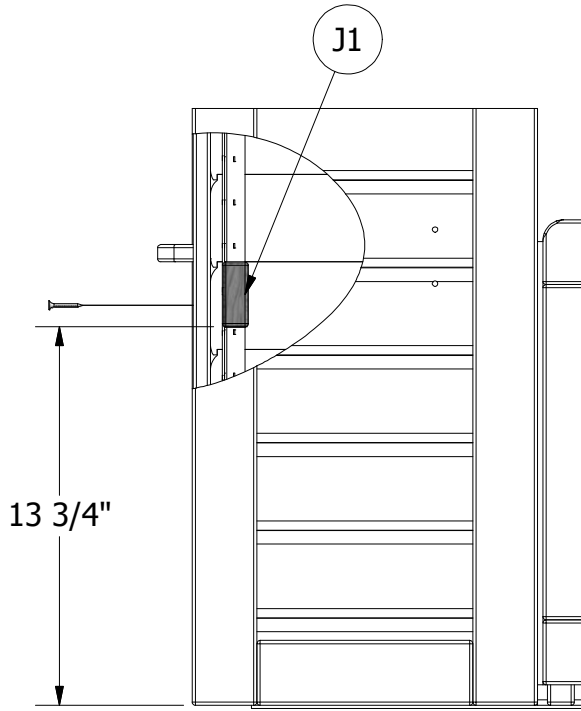

13 3/4"

**DAVANTI**

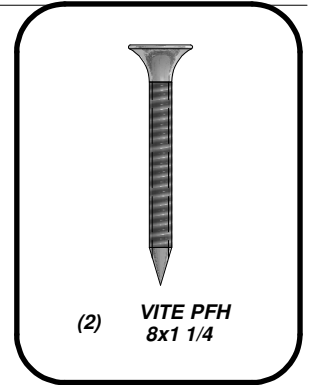

(2) **VITE PFH**  
8x1 1/4

VITE PFH 8x1 1/4  
(2 PLCS)

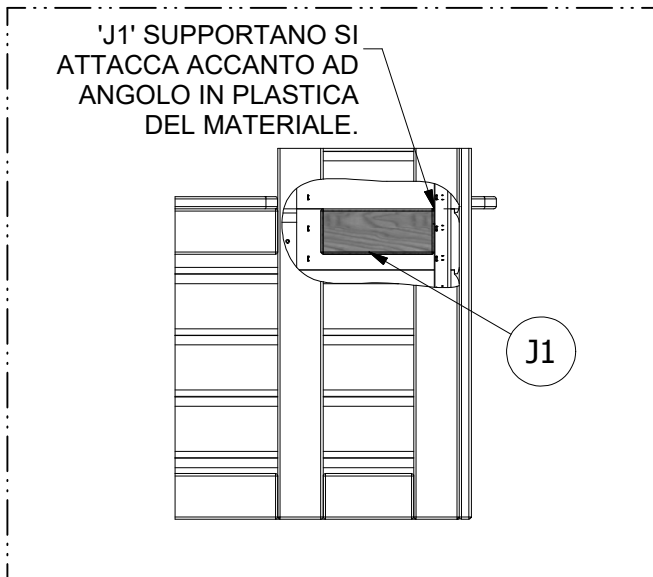

'J1' SUPPORTANO SI  
ATTACCA ACCANTO AD  
ANGOLO IN PLASTICA  
DEL MATERIALE.

J1

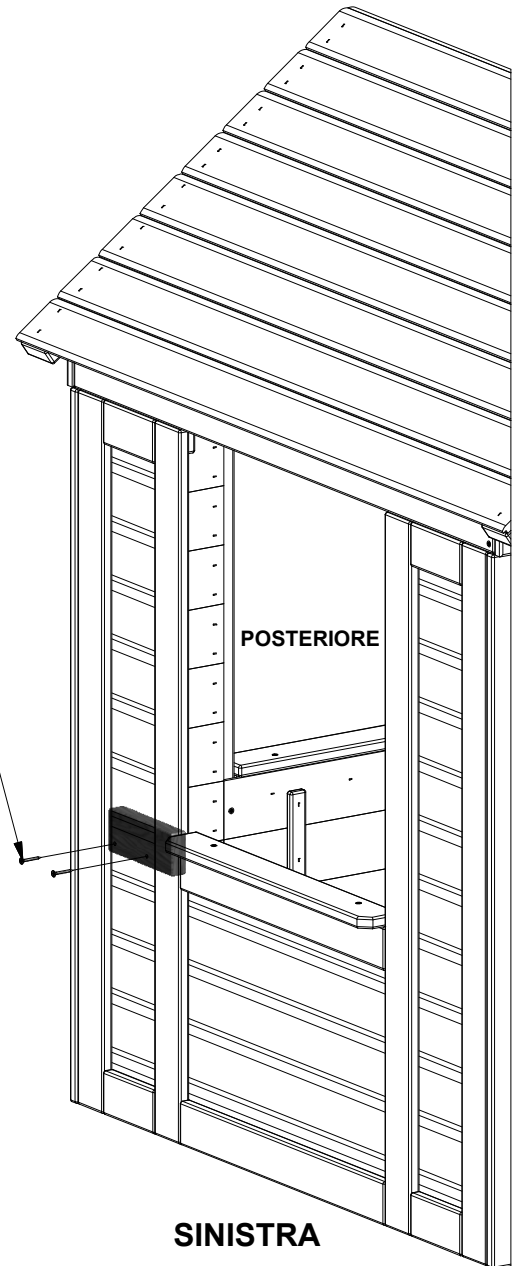

POSTERIORE

**SINISTRA**



(2) **M1 - BANCONE - W4L04754**  
5/8"x3 3/8"x23 5/8" (16x86x600)

**PASSO 18:**

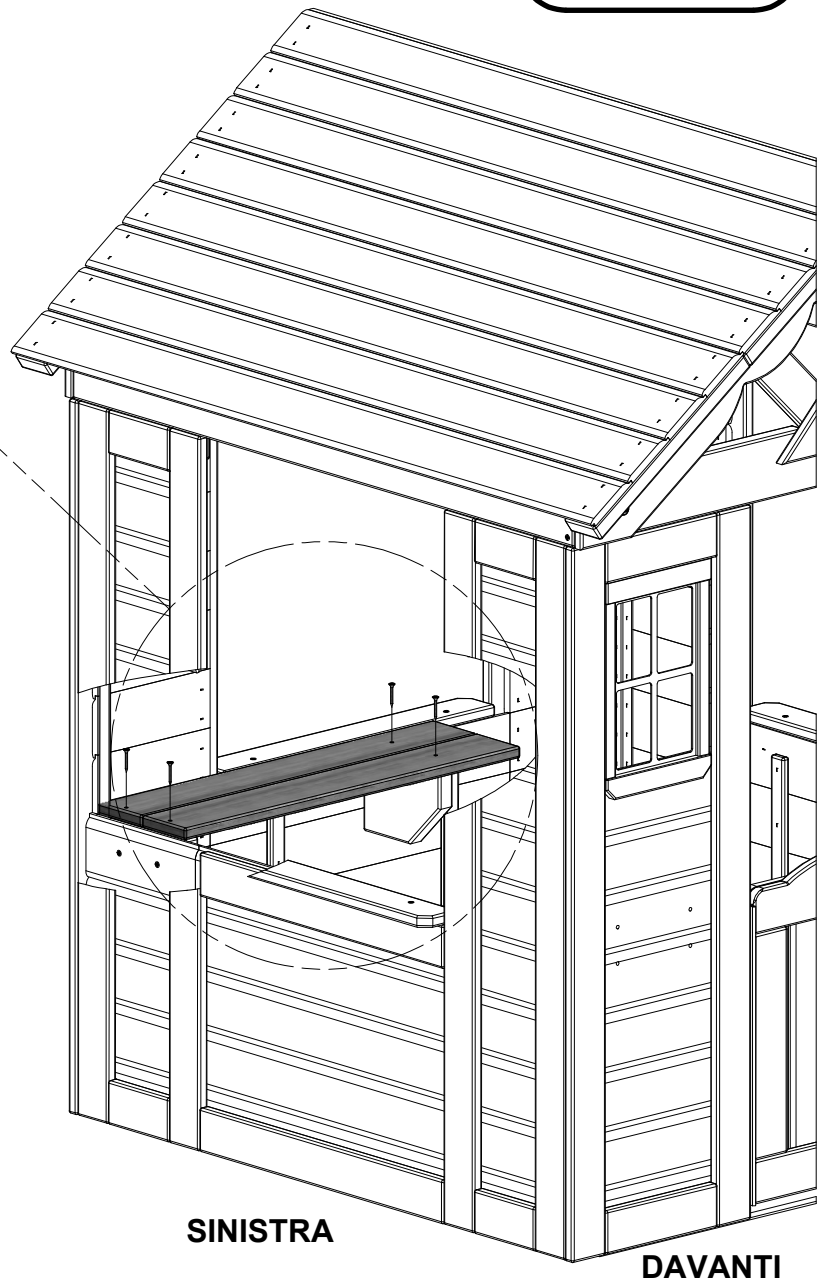
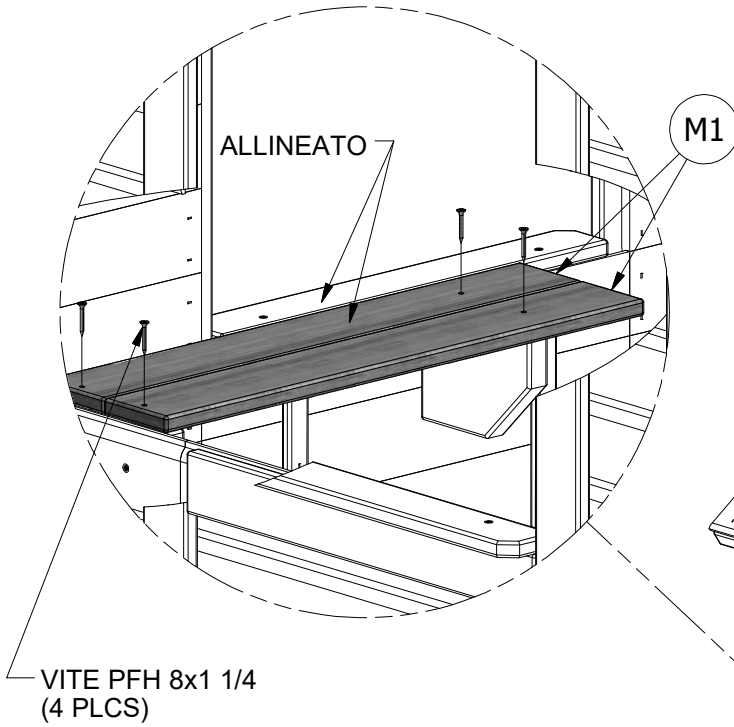
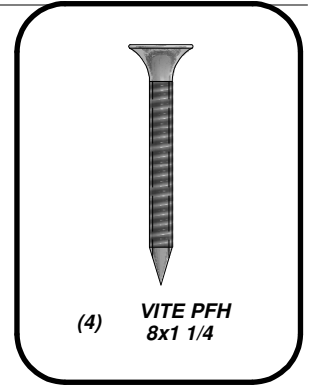

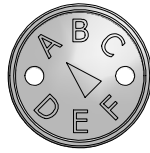

(1) **TARGETTA "A" REVISIONE - A100314**

**PASSO 19:**

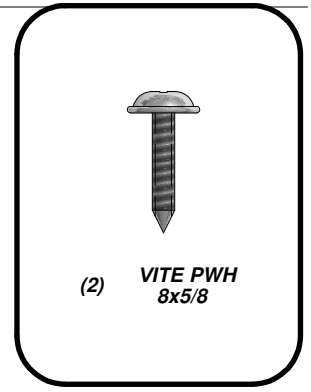
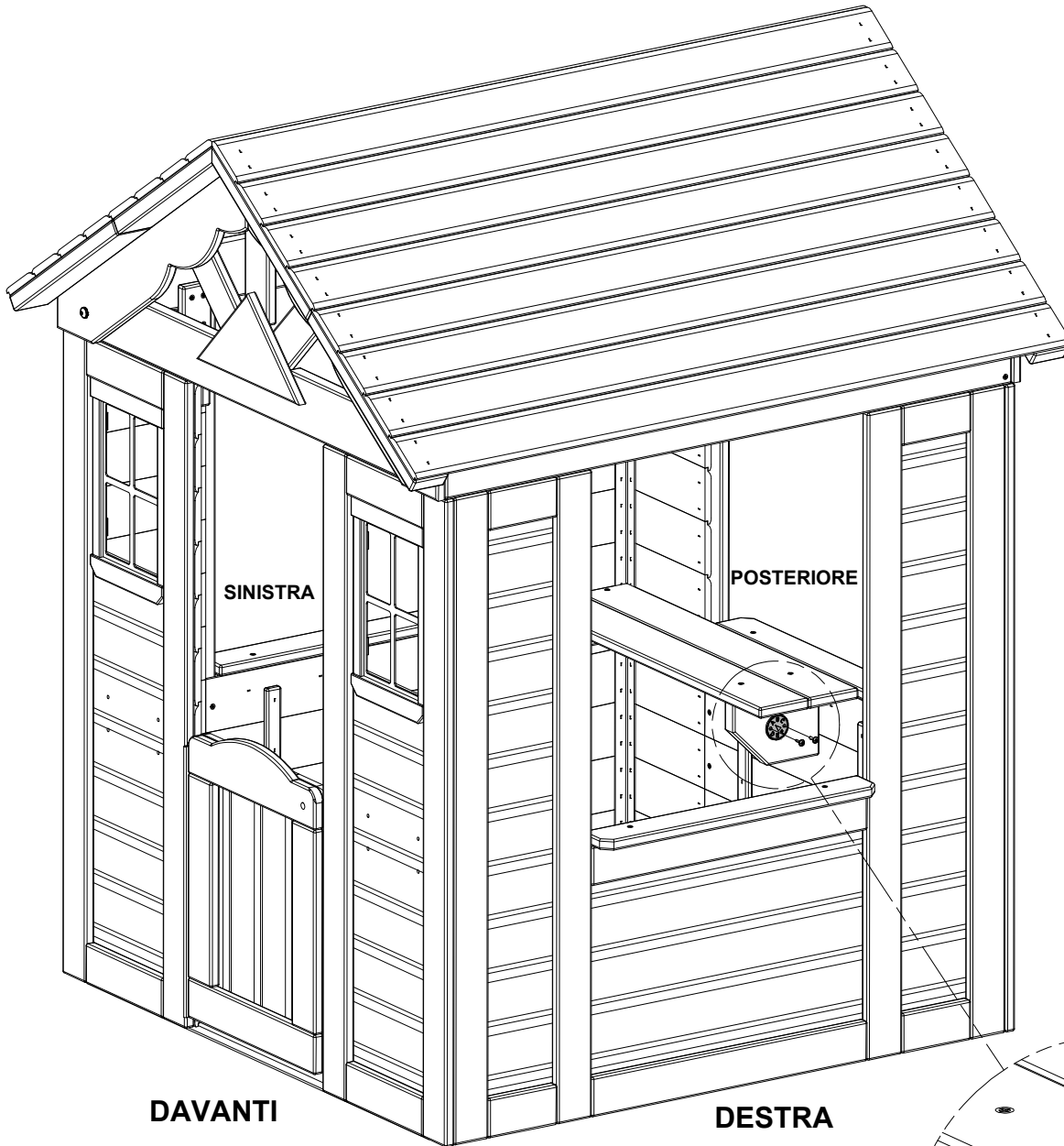

(2) **VITE PWH  
8x5/8**

VITE PWH 8x5/8  
(2 PLCS)

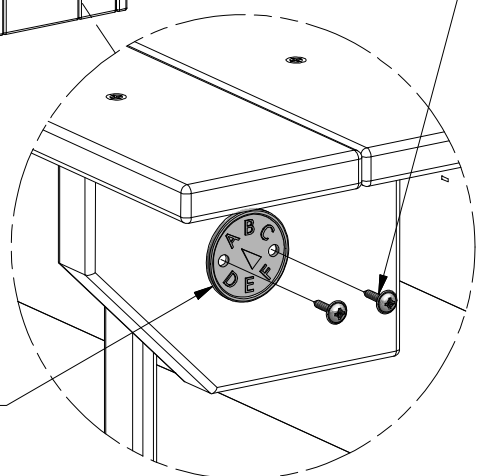

TARGETTA "A" REVISIONE

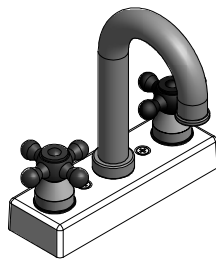

(1) KIT DEL RUBINETTO - A6P00024

PASSO 20:

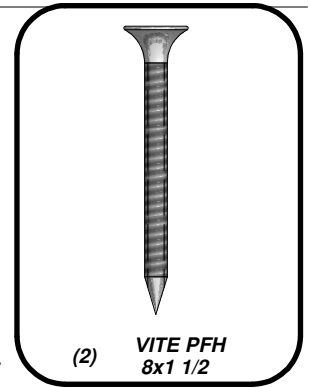
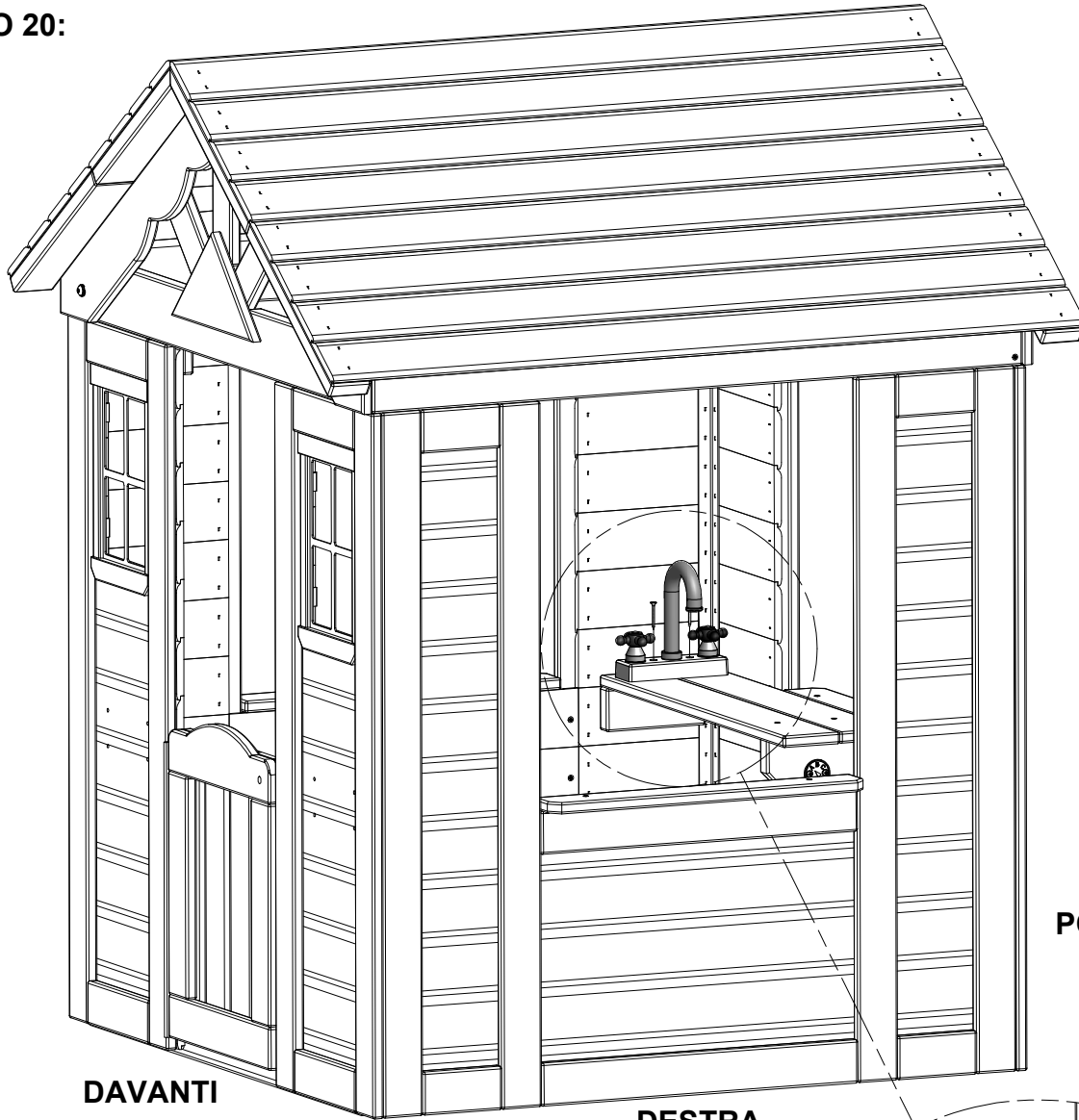

(2) VITE PFH  
8x1 1/2

DAVANTI

DESTRA

POSTERIORE

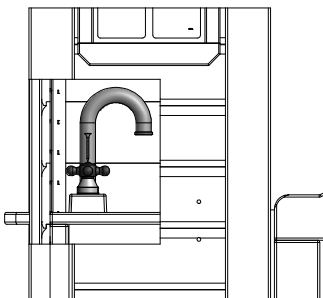

1"

VITE PFH 8x1 1/2  
(2 PLCS)

KIT DEL RUBINETTO

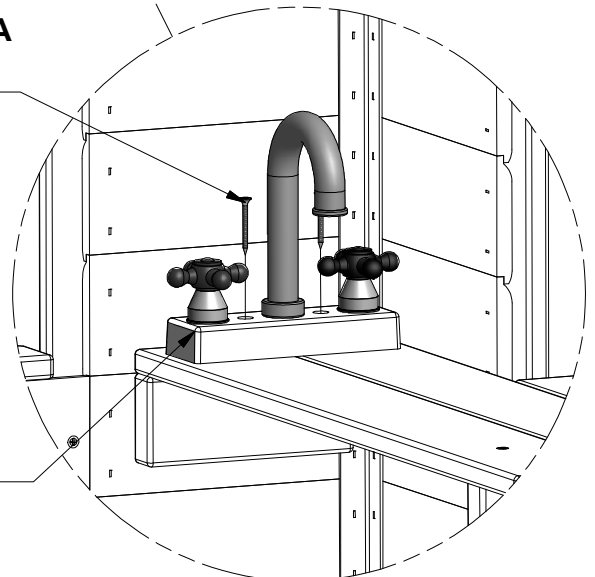

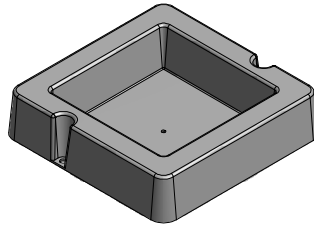

(1) VASCA DI MONTAGGIO DELLA SUPERFICIE - A6P00032

PASSO 21:

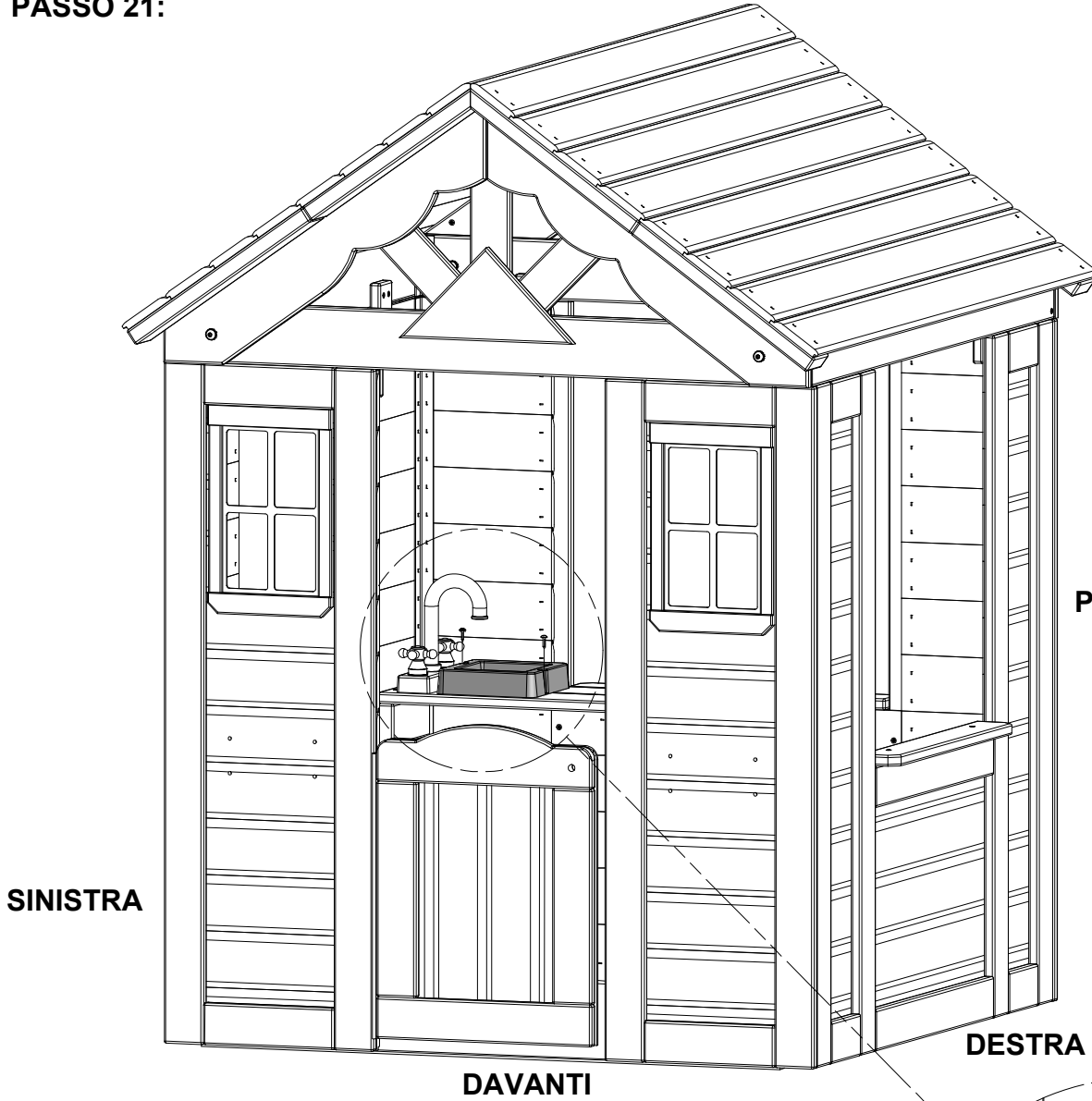
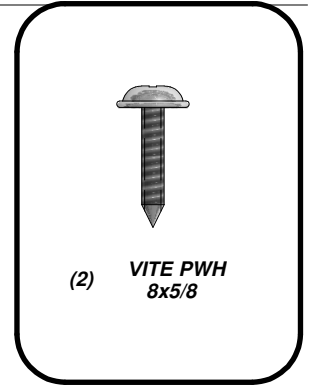

POSTERIORE

SINISTRA

DESTRA

DAVANTI

VITE PWH 8x5/8  
(2 PLCS)

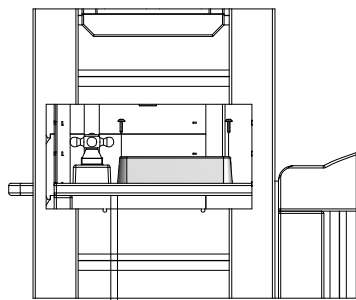

3/8"

VASCA DI MONTAGGIO DELLA SUPERFICIE

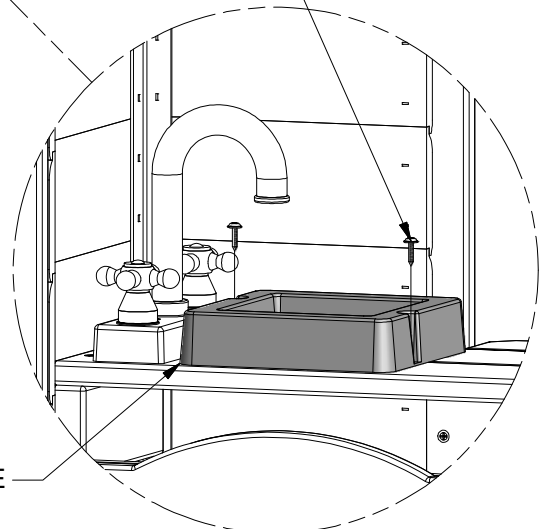

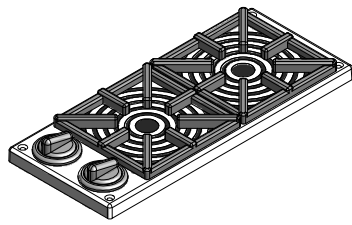

(1) KIT FORNELLI - A6P00025

**PASSO 22:**

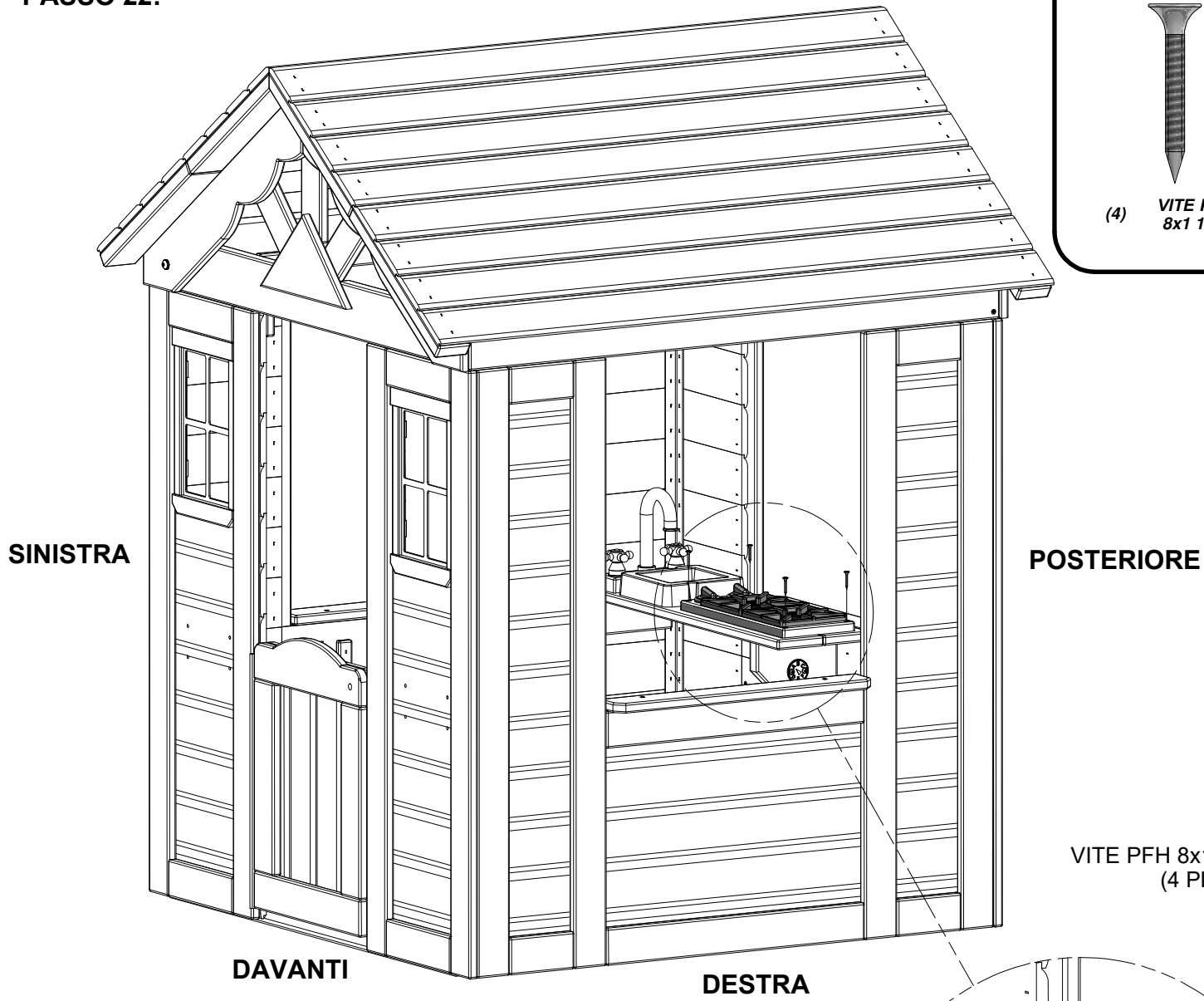
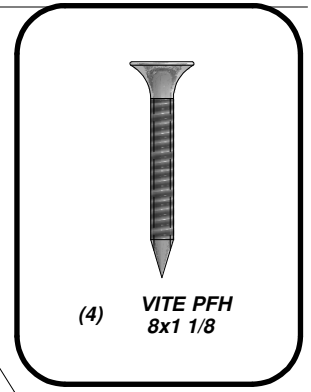

VITE PFH 8x1 1/8  
(4 PLCS)

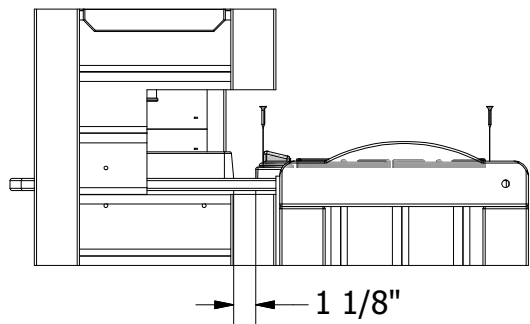

KIT FORNELLI

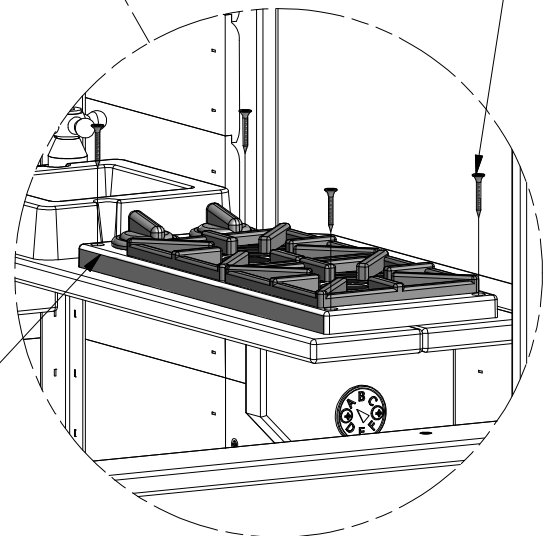

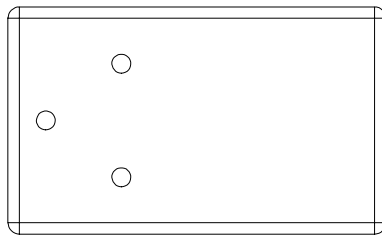

(1) **N3 - FERMO PORTA - W4L04761**  
**5/8"x2 3/8"x3 7/8" (16x60x100)**

**PASSO 23:**

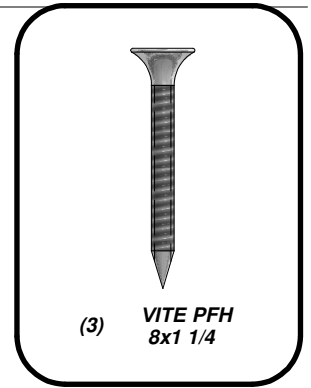
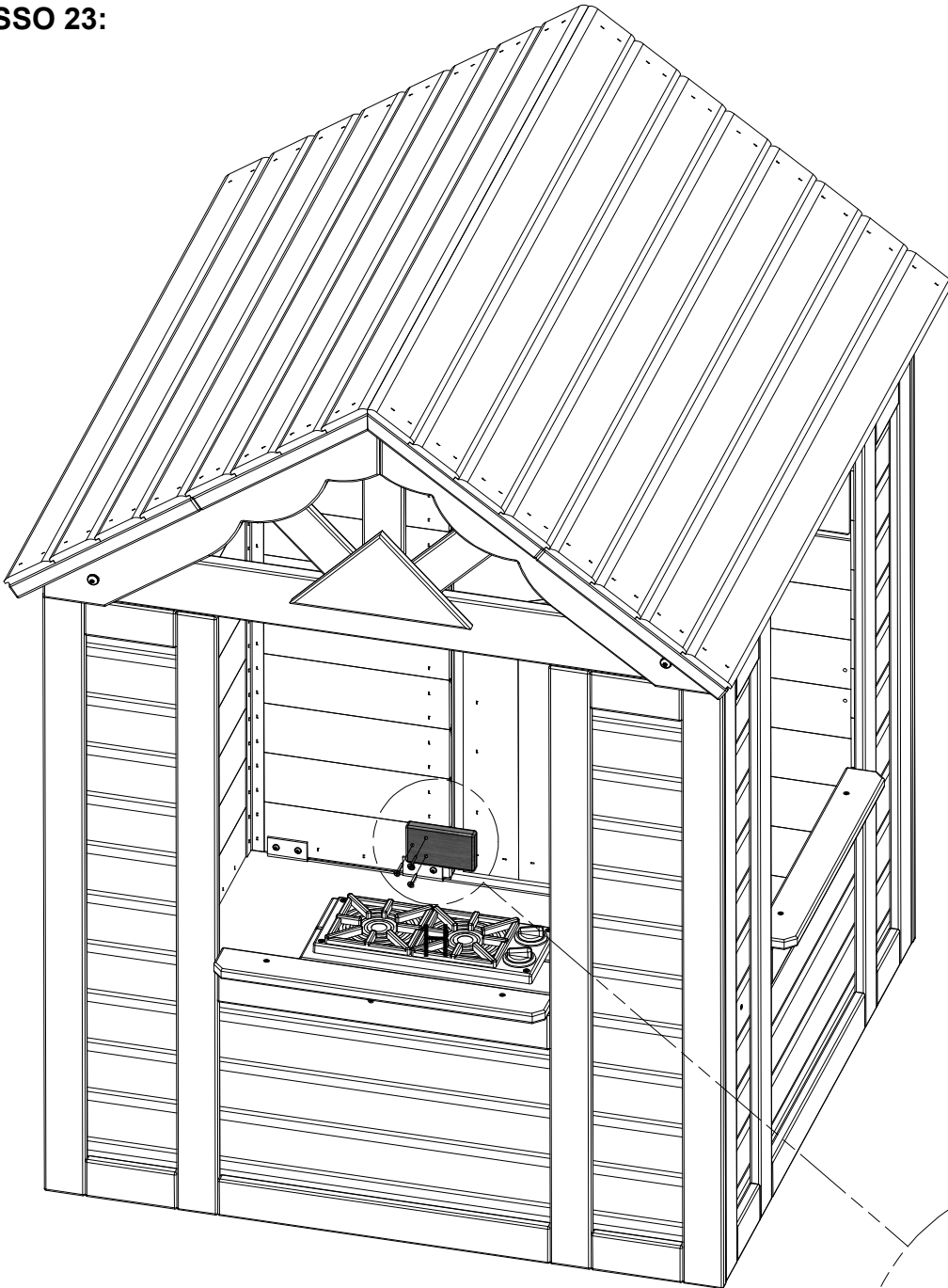

VITE PFH 8x1 1/4  
(3 PLCS)

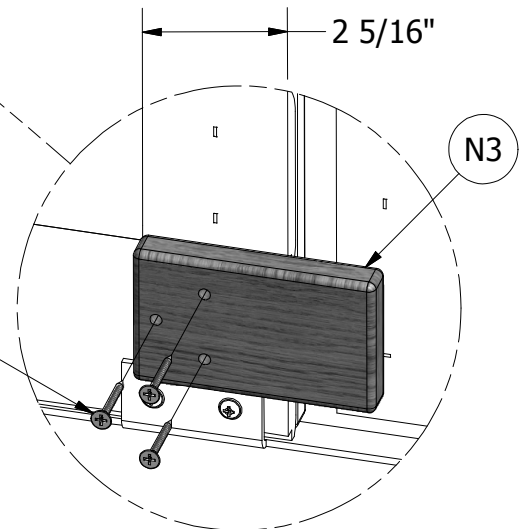

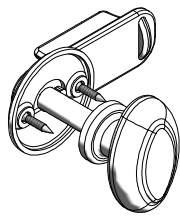

(1) KID DEL POMELLO - A6P00020

**PASSO 24:**

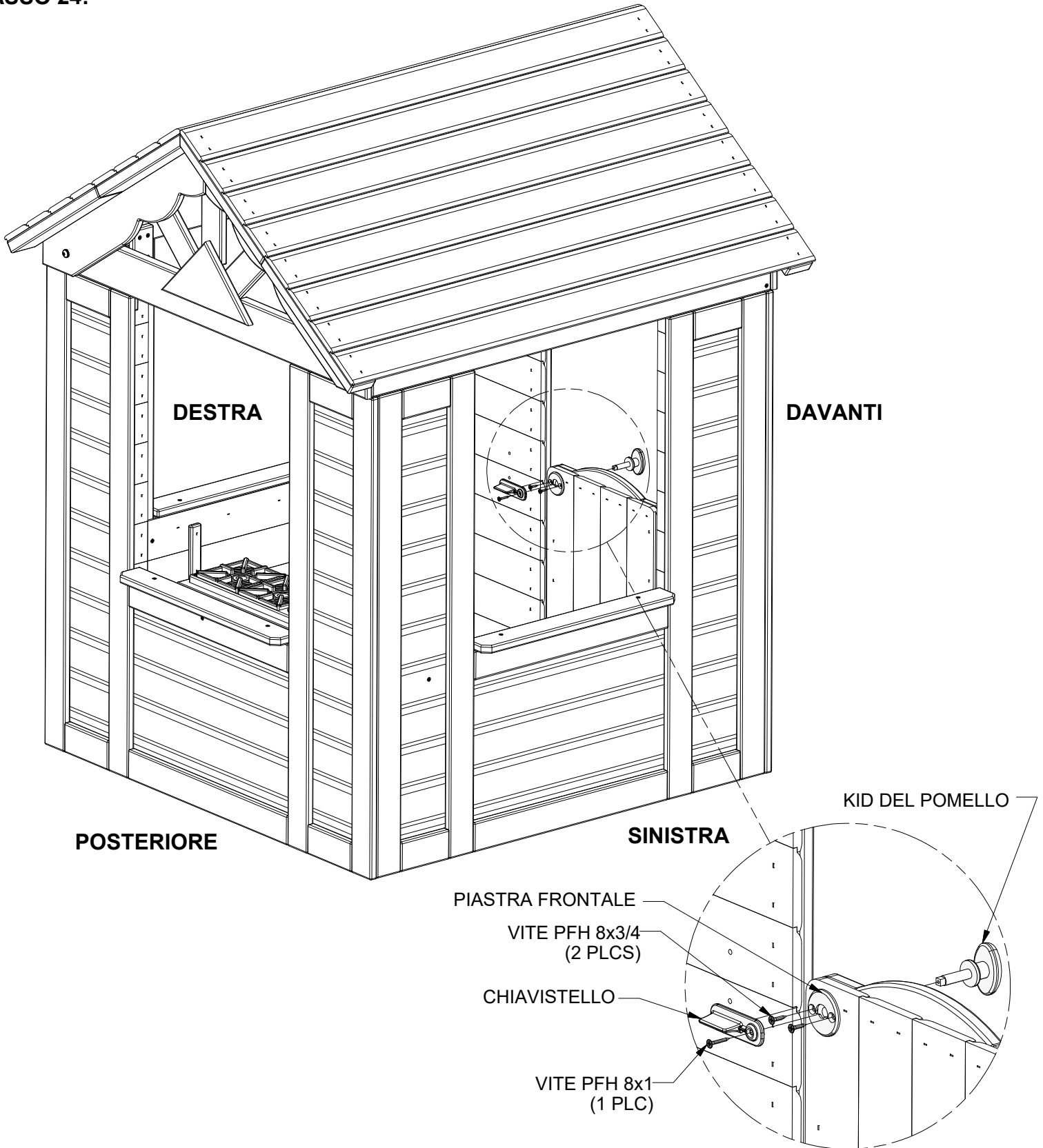



(1) KIT PER TELEFONO - A100132

PASSO 25:

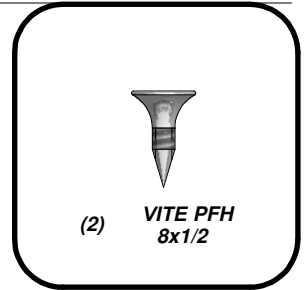

(2) VITE PFH  
8x1/2

SINISTRA

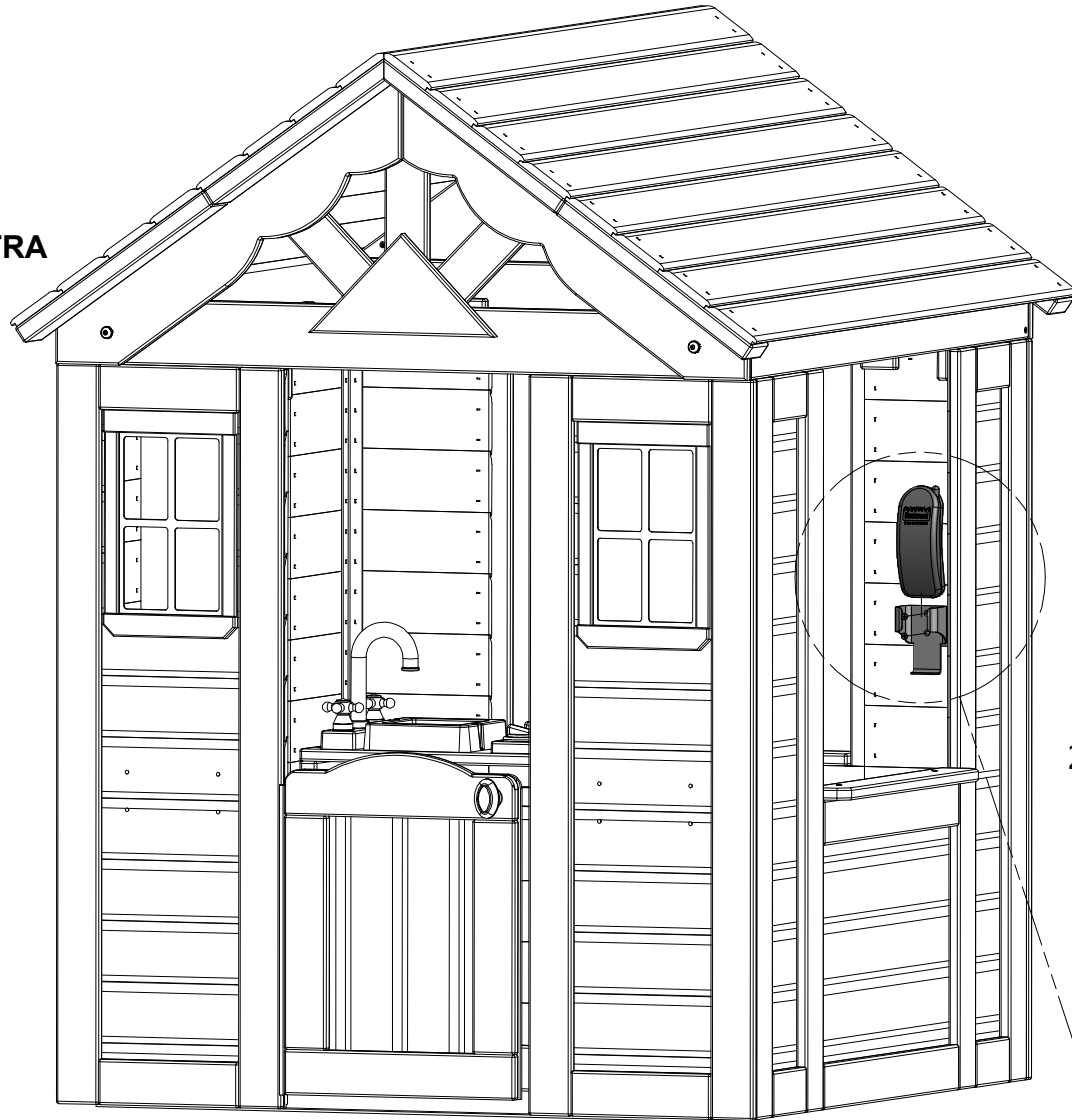

POSTERIORE

24 5/8"

DAVANTI

DESTRA

KIT PER TELEFONO

VITE PFH 8x1/2  
(2 PLCS)

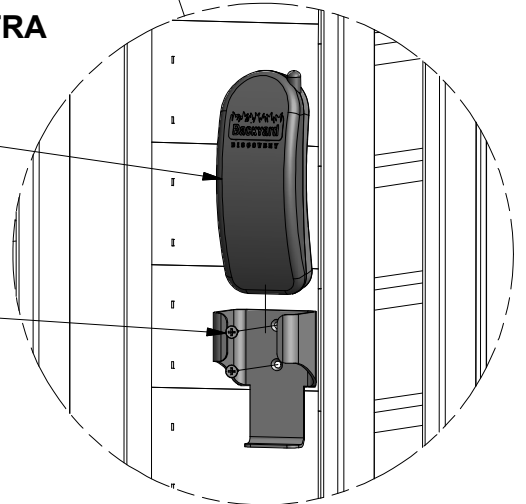

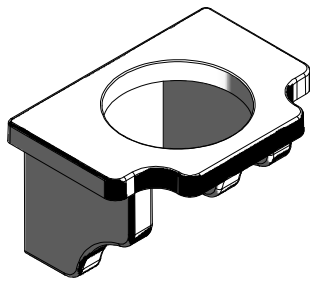

**(2) PORTA VASO DA FIORI - A6P00023**

**PASSO 26:**

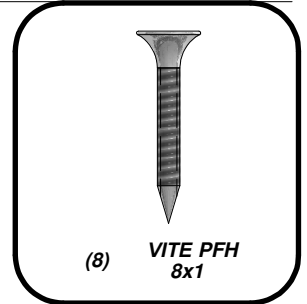

**(8) VITE PFH  
8x1**

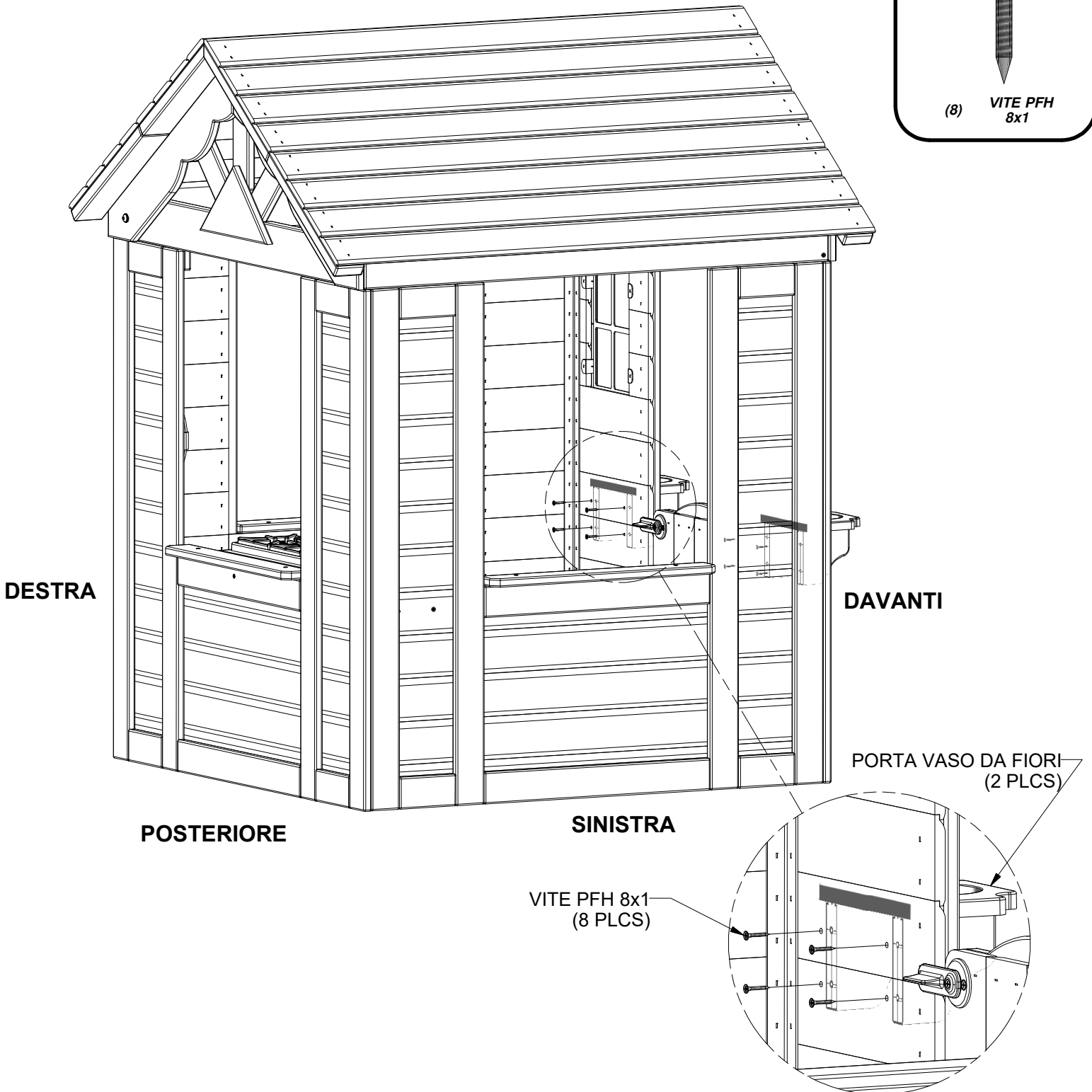



(1) **BYD TARGETTA ID (MEDIA) ETA' DA 2 A 10 - A4M00528**

**PASSO 27:**

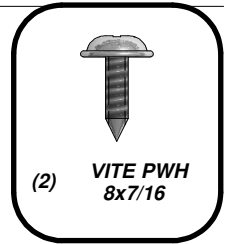

**POSTERIORE**

**SINISTRA**

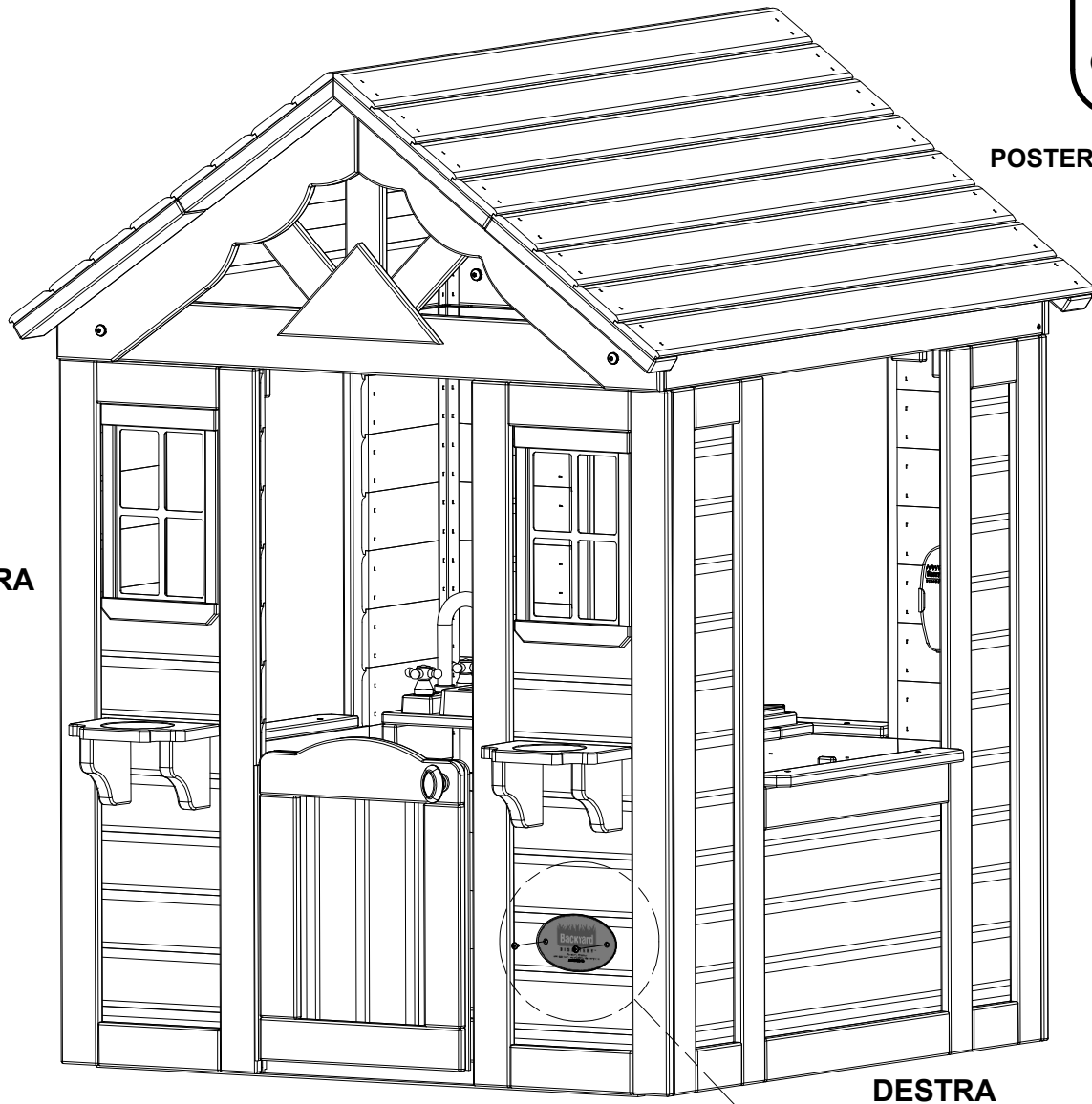

**DAVANTI**

**DESTRA**

VITE PWH 8x7/16  
(2 PLCS)

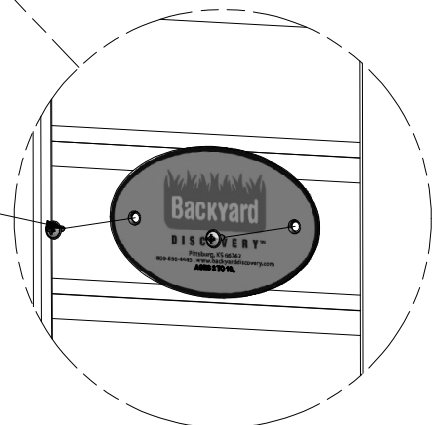

## Garanzia limitata della

Presente garanzia limitata dalla scoperta del cortile si applica ai prodotti fabbricati sotto il Backyard scoperta marca o gli altri suoi marchi inclusi ma non limitati a Backyard botanica, avventura, predefiniti e tempo libero prodotti.

Backyard Discovery garantisce che questo prodotto è esente da difetti nei materiali e di fabbricazione per un periodo di un (1) anno a partire dalla data di acquisto originale. Questo un (1) anno di garanzia copre tutte le parti compreso il legno, hardware e gli accessori. Tutto il legno porta a cinque (5) anni di pro-rated garanzia contro la decomposizione e il decadimento. Consultare la tabella riportata sotto per i costi associati con la sostituzione delle parti sotto questa garanzia limitata. In aggiunta, Backyard scoperta andrà a sostituire eventuali parti entro i primi trenta giorni a partire dalla data di acquisto trovati essere mancante o danneggiata nella confezione originale.

Questa garanzia si applica al proprietario originale e registrante e non è trasferibile. Una manutenzione regolare è richiesto per assicurare la massima durata e prestazioni di questo prodotto e l'inosservanza da parte del proprietario per mantenere il prodotto secondo le esigenze di manutenzione può invalidare la garanzia. Linee guida sulla manutenzione sono forniti nel Manuale del proprietario.

La presente Garanzia Limitata non copre:

- Manodopera per qualsiasi ispezione
- Manodopera per la sostituzione di qualsiasi articolo difettoso(s)
- Danni incidentali o consequenziali
- Difetti estetici che non influenzano le prestazioni o l'integrità di una parte o della totalità del prodotto
- Vandalismo, uso improprio, guasti dovuti alle operazioni di carico o di usare al di là delle capacità indicate nel relativo manuale di montaggio.
- Atti di natura incluso ma non limitato al vento, tempesta, grandine, inondazioni, eccessiva esposizione ad acqua
- Installazione impropria incluso ma non limitato all'installazione su superfici irregolari, unlevel, o terreno morbido
- Torsione minore, orditura, controllo, o di qualsiasi altro avvenimento naturale proprietà del legno che non influenzano le prestazioni o l'integrità

Backyard prodotti Discovery sono stati progettati per la sicurezza e la qualità. Eventuali modifiche apportate al prodotto originale potrebbe danneggiare l'integrità strutturale dell'unità che portano al fallimento e possibili lesioni. Modifica vuoti qualsiasi e tutte le garanzie e Backyard scoperta non si assume alcuna responsabilità per eventuali prodotti modificati o conseguenze derivanti dal fallimento di un prodotto modificato.

Questo prodotto è garantito per uso residenziale solo. In nessuna circostanza dovrebbe un cortile prodotto Discovery essere utilizzato in pubblico le impostazioni. Tale uso può causare il malfunzionamento del prodotto e il rischio di infortuni. Ogni e qualsiasi uso pubblico renderà nulla la garanzia. Backyard scoperta declina tutte le altre rappresentazioni e garanzie di alcun tipo, espressa o implicita.

La presente garanzia dà luogo a specifici diritti legali. Si possono avere altri diritti oltre che variano da Stato a Stato e da provincia a provincia. La presente garanzia esclude tutti i danni consequenziali, tuttavia, alcuni stati non consentono la limitazione o esclusione di danni consequenziali e pertanto questa limitazione potrebbe non essere applicabile all'utente.

### Pro parte nominale sostituzione pianificata

#### Età del Prodotto

#### **Tutte le Parti**

0-30 giorni a partire dalla data di acquisto 31 giorni per 1 anno

#### **Marciume del Legno e la Carie Solo**

1 anno

2 anni

3 anni

4 anni

5 anni

Oltre 5 anni

#### Il cliente paga

\$0 e spedizione gratuita in  
\$0 S&H

0 dollari e spedizione gratuita

20% + S&H

40% + S&H

60% + S&H

80% + S&H

100% + S&H

