

Pallet A (BOX2*10)

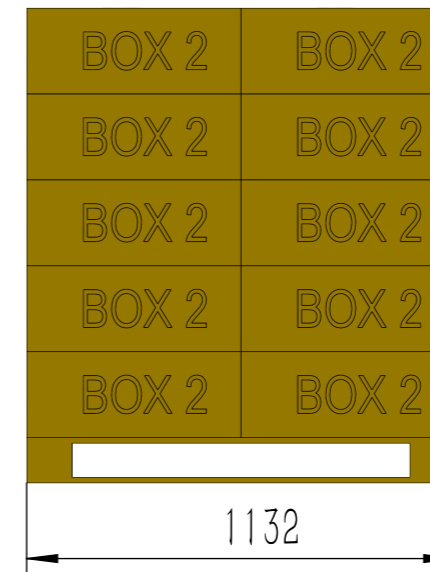

Pallet B, 木箱需要打钢带固定

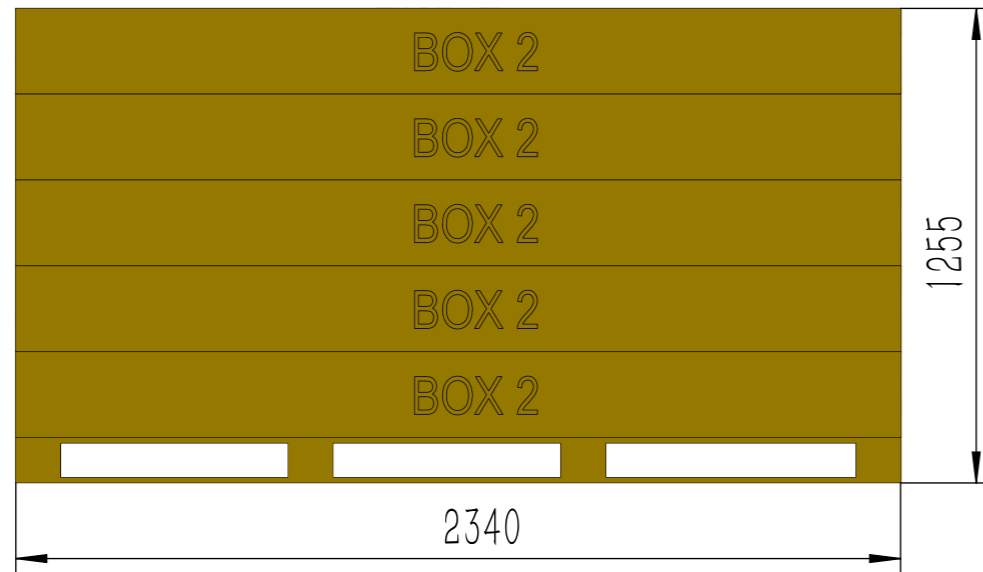
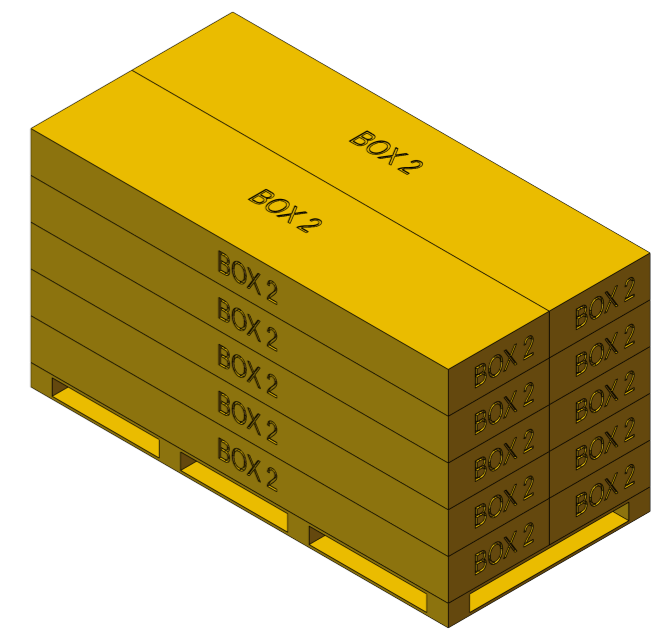
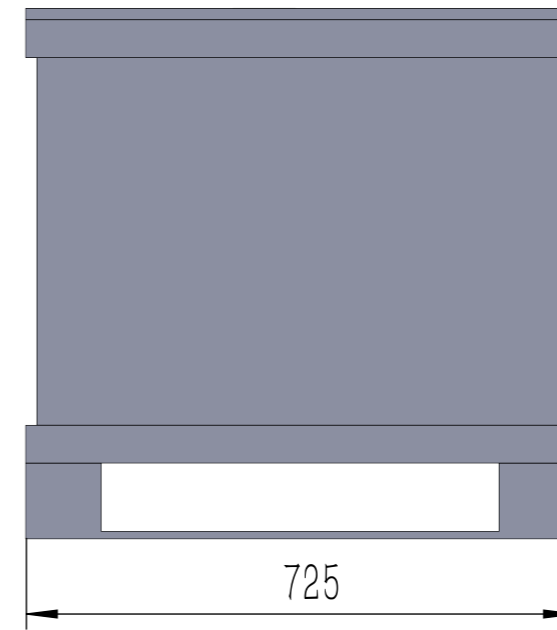
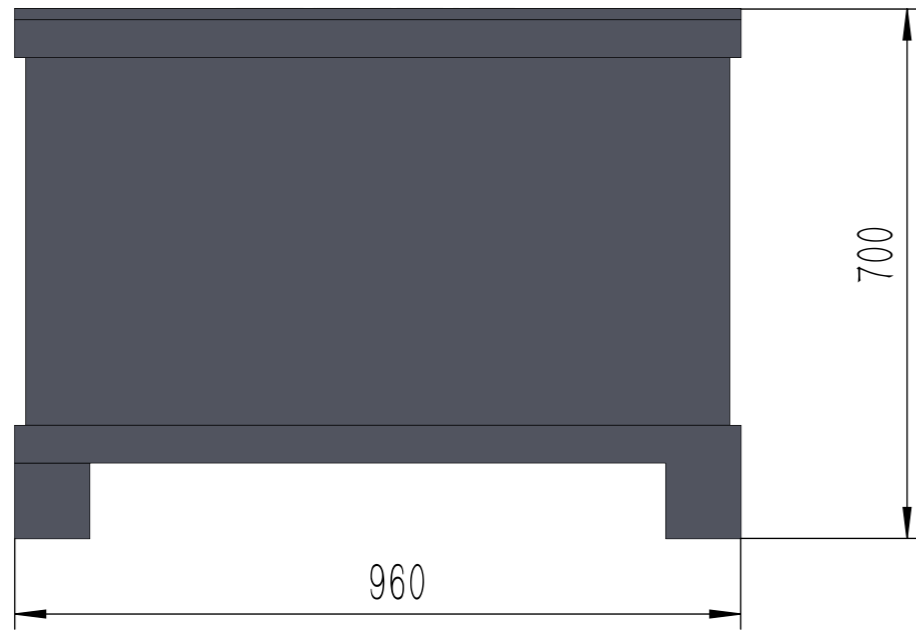
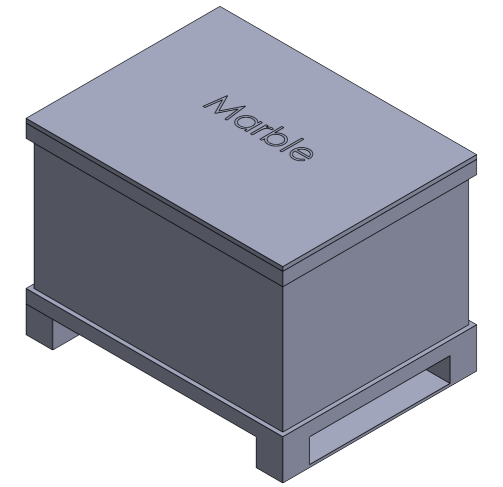

Pallet C (BOX3*20) , 整托需要打扎带与托盘固定

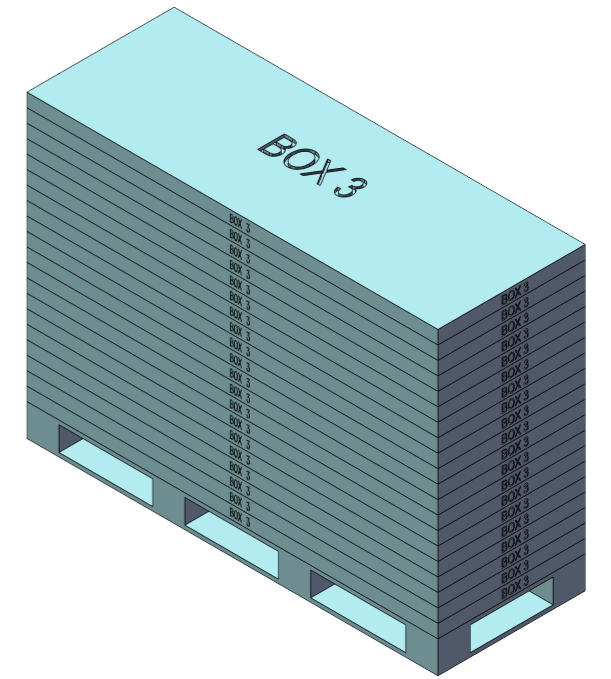
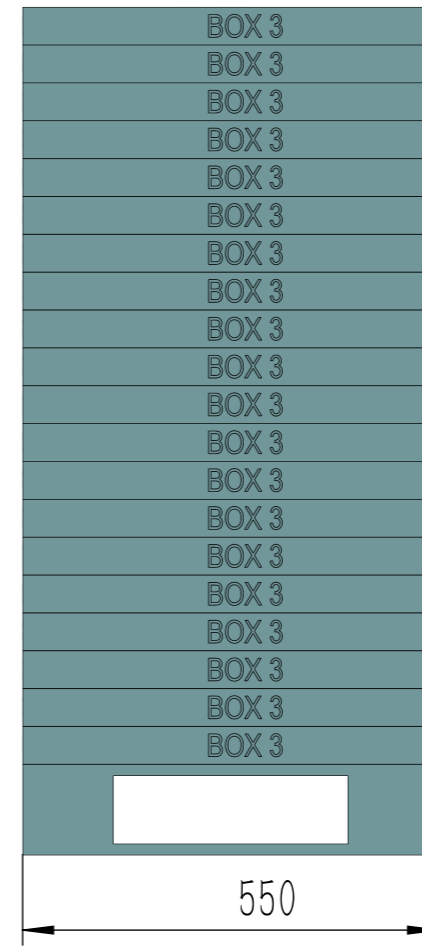
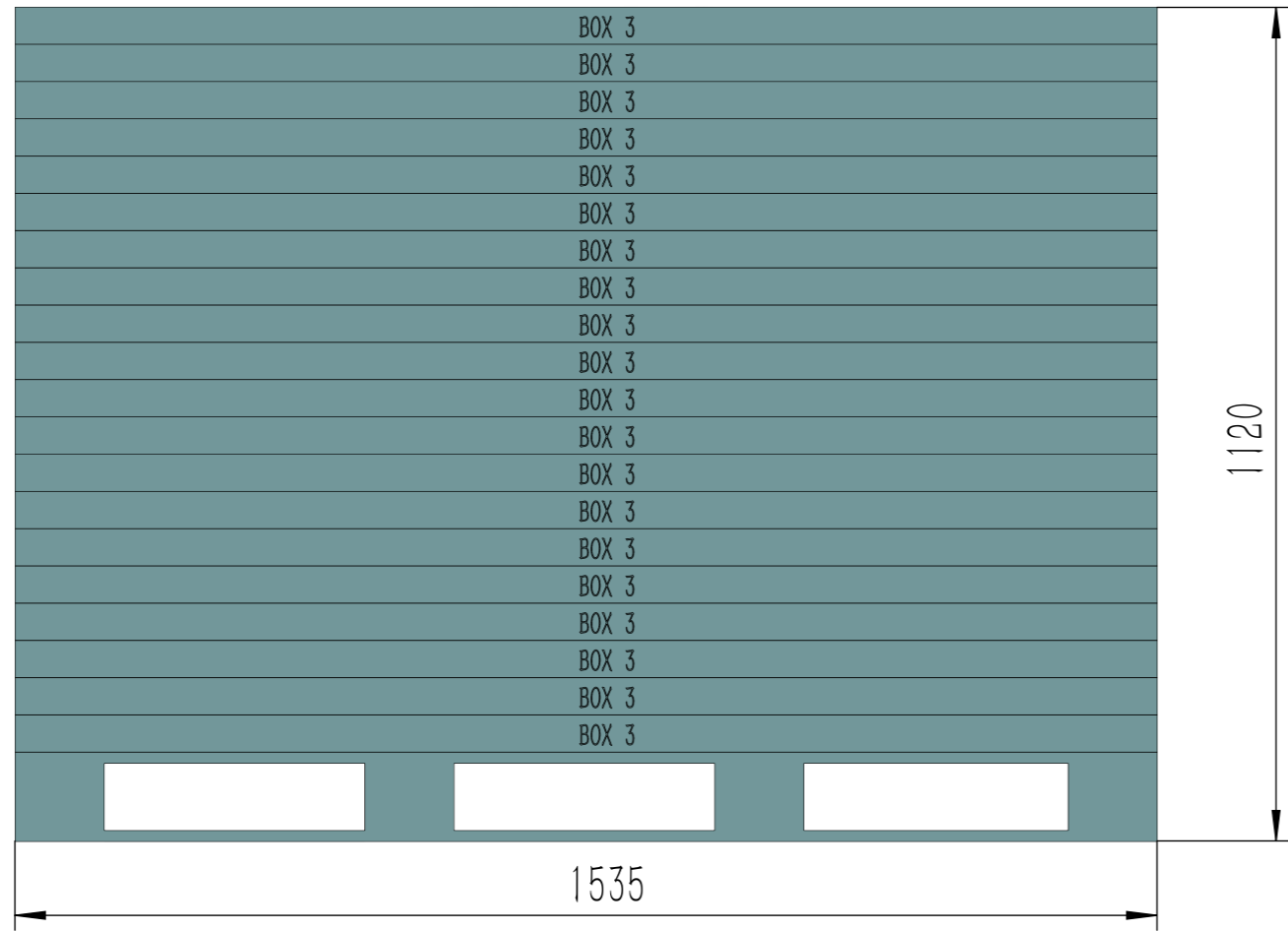

Pallet D (BOX1*13) , 单箱打扎带 , 整托也需要打扎带与托盘固定

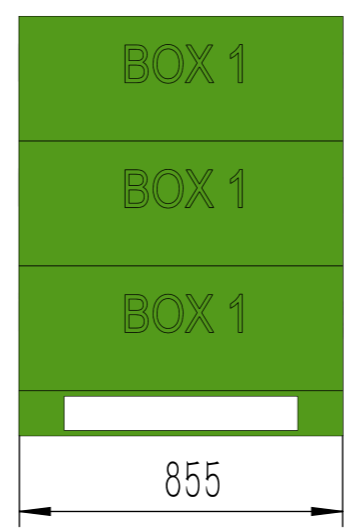
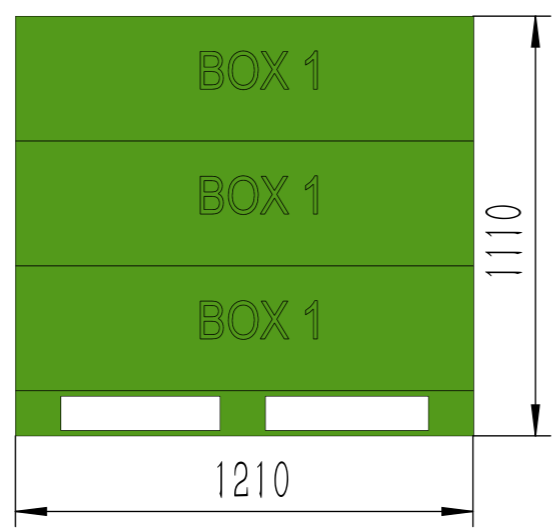

Pallet E (BOX1*1) , 单箱打扎带 , 整托也需要打扎带与托盘固定

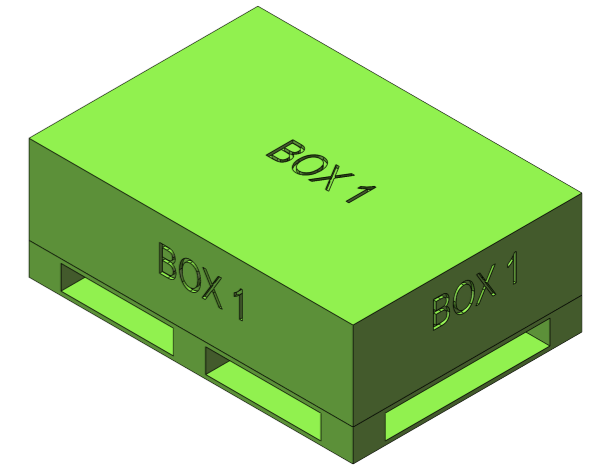
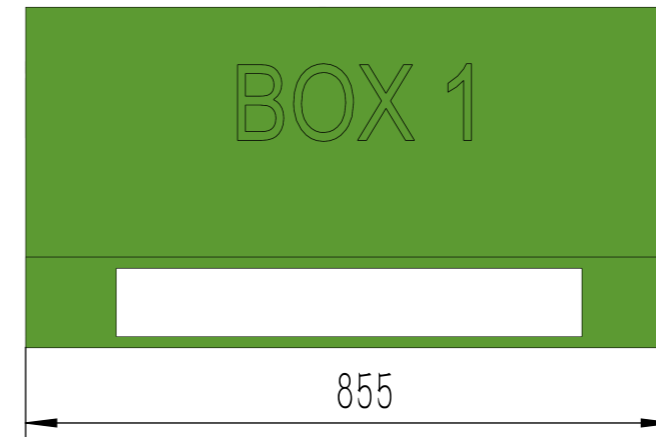
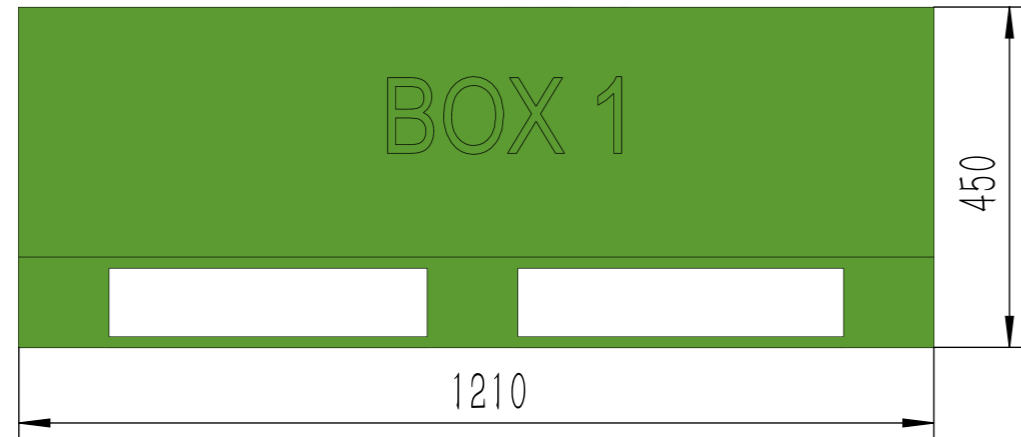

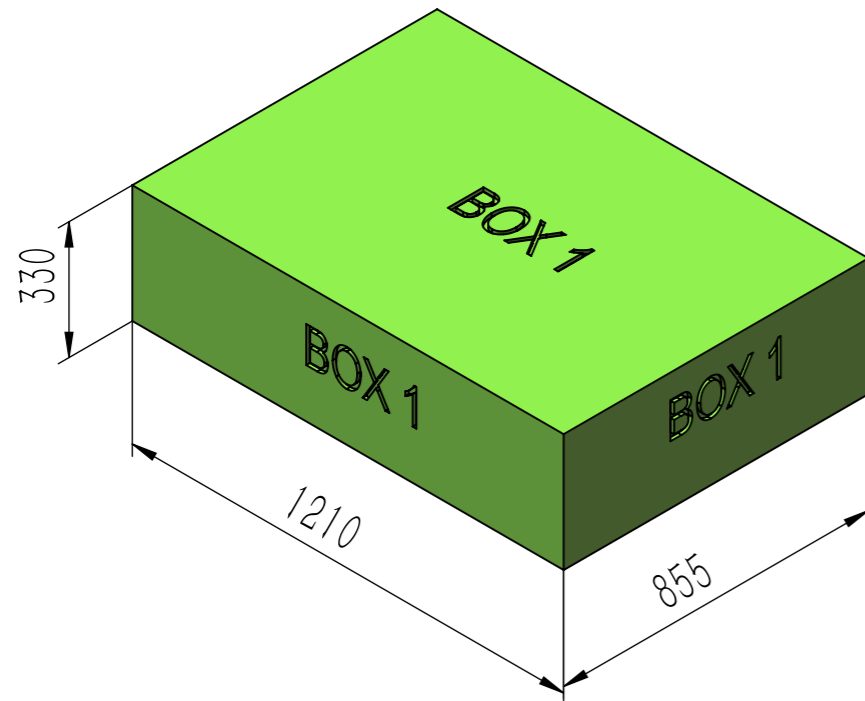

BOX1: 87KG

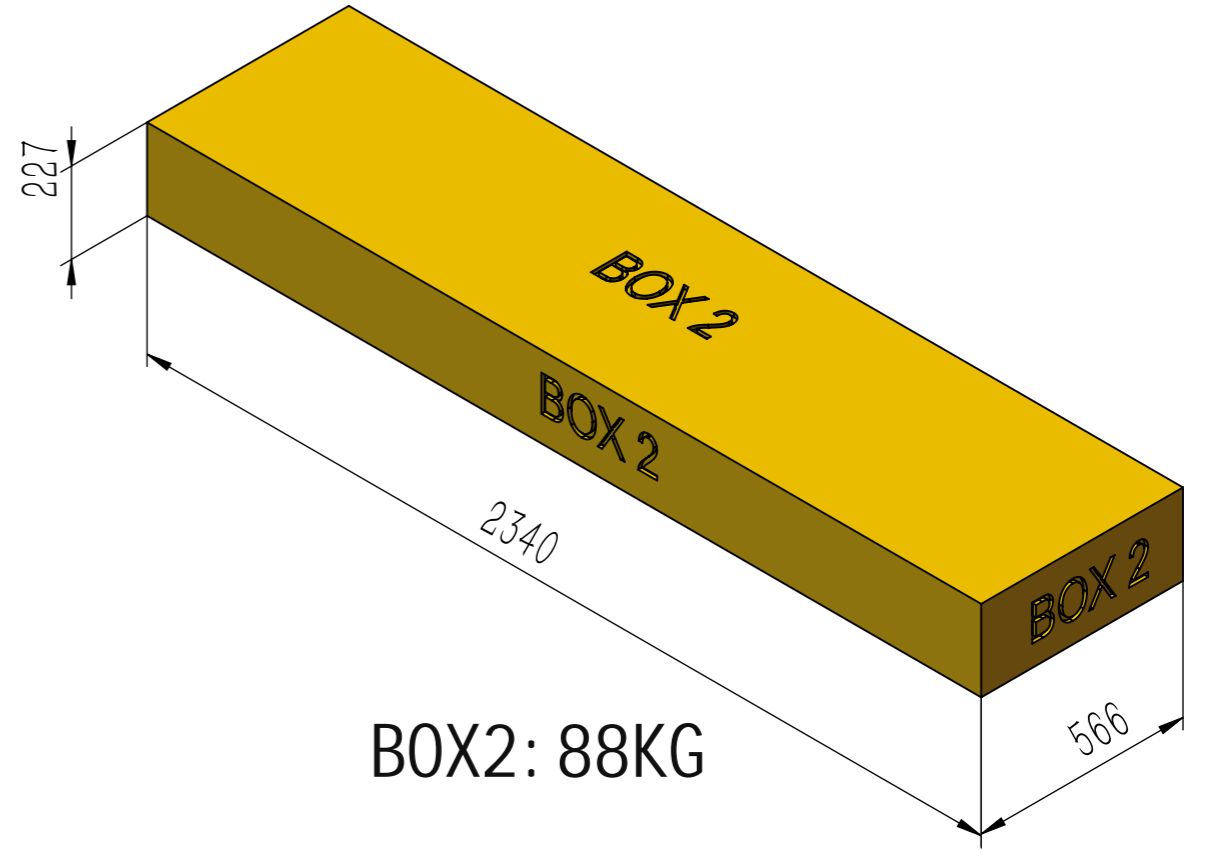

BOX2: 88KG

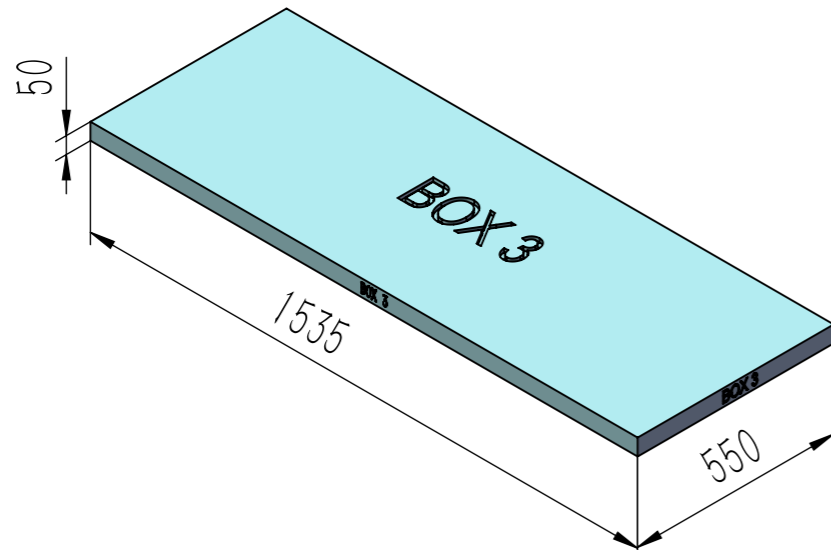

BOX3: 26.5KG

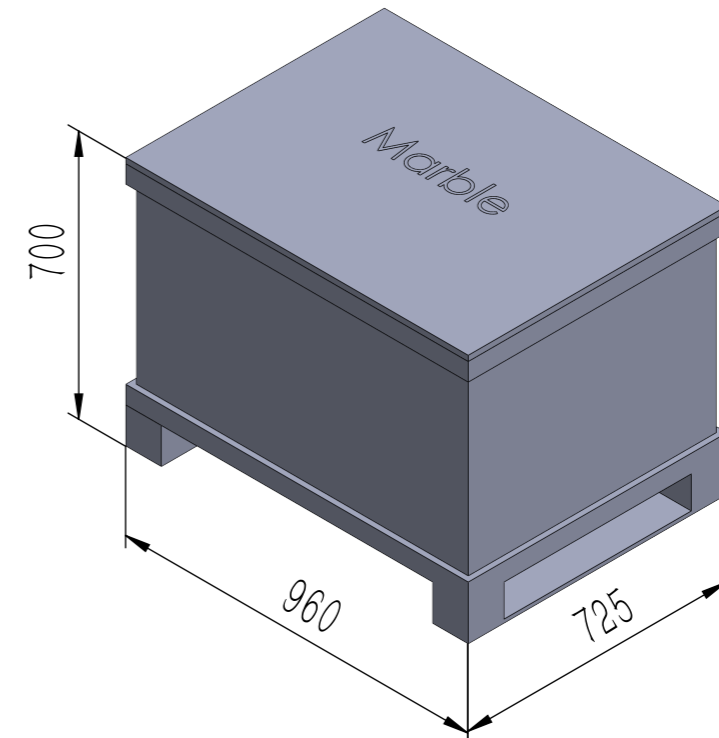

BOX4: 140KG