

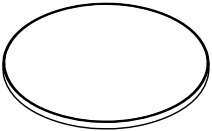

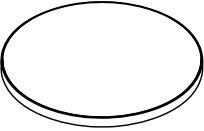

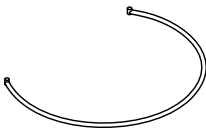
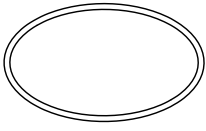

ASSEMBLY INSTRUCTION

ROUND NESTING COFFEE TABLE WITH TOP

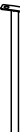
A Top for Large Table	B Top for Small Table	C Arc Metal Frame	D Round Metal Frame
			
1PC	1PC	1PC	1PC
E Short Leg Rail	F Long Leg Rail	G Leg Rail	H Long Bolt 1/4*1-1/2"
			
2PCS	1PC	3PCS	6PCS
I Short Bolt 1/4*5/8"	J Flat Washer 1/4"X16mm	K Allen Wrench 4mm	
			
12PCS	12PCS	1PC	

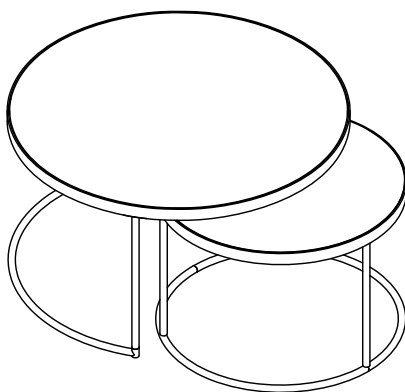

This page lists all the contents included in the box. Please take the time to identify the hardware as well as the individual components to this product. As you unpack and prepare for assembly, place the contents on a carpeted or padded area to protect them from damage.

- 1** Attach Short & Long Leg Rail (E&F) to Top for Large Table (A) by using Flat Washer (J), Short Bolt (I) and Allen Wrench (K). Then attach Arc Metal Frame (C) and Short & Long Leg Rail (E&F) together by using Long Bolt (H) and Allen Wrench (K).

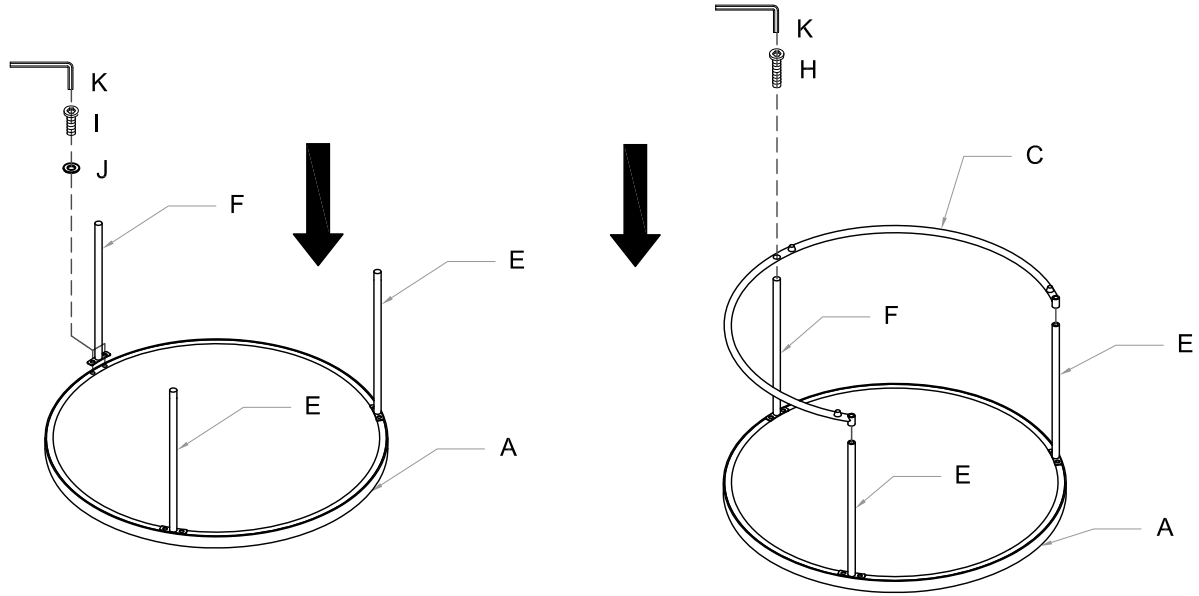

Large Table

- 2** Attach Leg Rail (G) to Top for Small Table (B) by using Flat Washer (J), Short Bolt (I) and Allen Wrench (K). Then attach Round Metal Frame (D) and Leg Rail (G) together by using Long Bolt (H) and Allen Wrench (K).

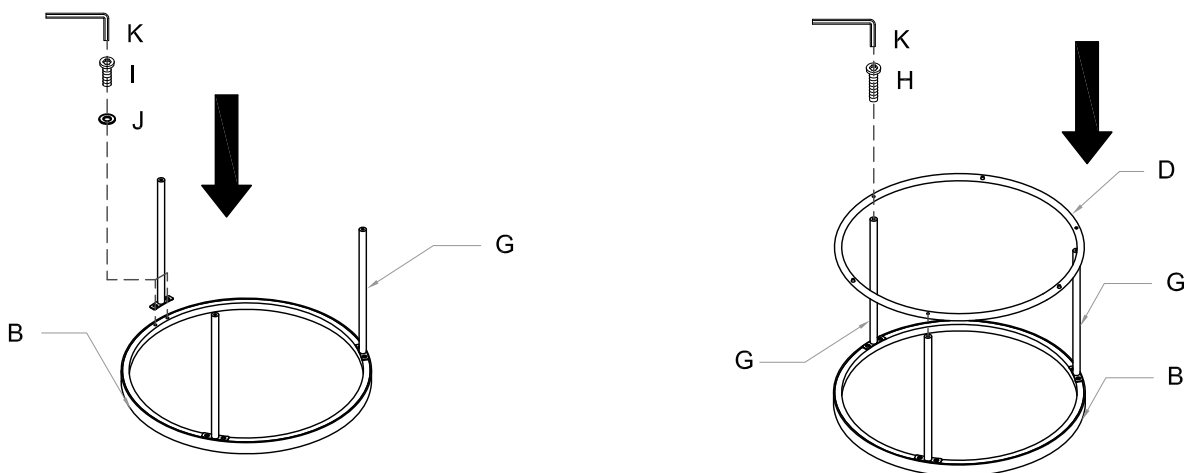

Small Table

Cleaning & Care

Treat surface with care. Surface is resistant to scratches but is not scratch resistant. Clean surfaces with a dry or damp soft cloth. Do not use abrasive cleaners. Hardware may loosen over time. Periodically check that all connections are tight.