

ASSEMBLY INSTRUCTIONS

METAL TWIN FULL BUNK BED

A Left Side Frame



1pc

B Right Side Frame



1pc

C Upper Slat Frame

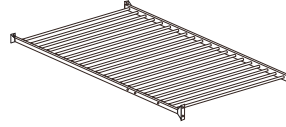

1pc

D Lower Slat Frame

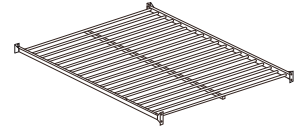

1pc

E Rear Guard Rail

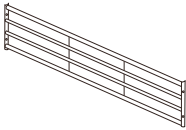

1pc

F Front Guard Rail

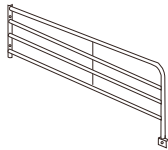

1pc

G Ladder Tube



2pcs

H Ladder Step

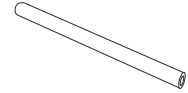

3pcs

I Bolt
5/16" x 60mm



J Bolt
1/4" x 25mm



K Bolt
5/16" x 25mm

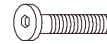

L Bolt
5/16" x 40mm



M Nut
5/16"



N Spring Washer
5/16"



O Flat Washer
5/8"



P Flat Washer
1 1/16"



Q L-Allen Key
M4



1pc

R L-Allen Key
M5



1pc

S Wrench
5/16"

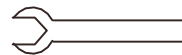

1pc

T Wing Nut
5/16"



6pcs

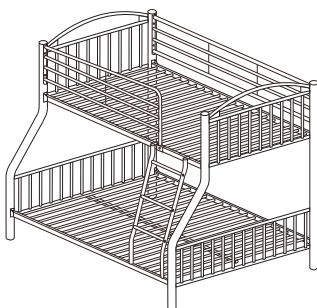

This page lists all the contents included in the box. Please take the time to identify the hardware as well as the individual components to this product. As you unpack and prepare for assembly, place the contents on a carpeted or padded area to protect them from damage.

- 1** Attach Left & Right Side Frame (A & B) to Upper & Lower Slat Frame (C & D) using Bolt (K), Spring Washer (N) and Flat Washer (P) with L-Allen Key (R).

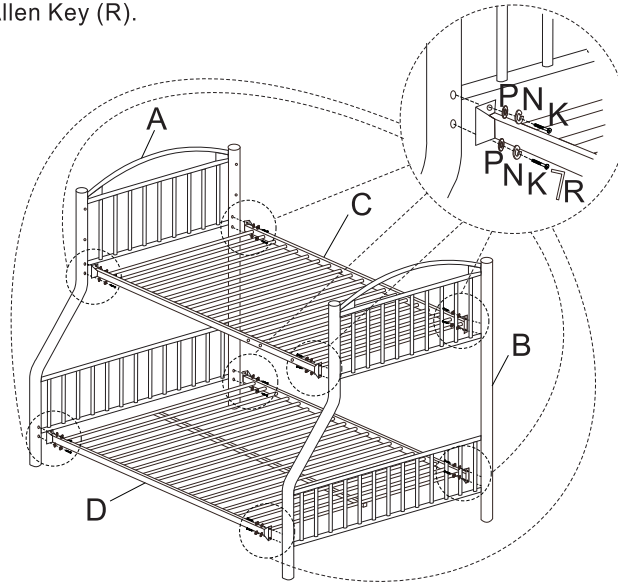

- 2** Attach Rear & Front Guard Rail (E & F) to Left & Right Side Frame (A & B) using Bolt (J) and Flat Washer (O) with L-Allen Key (Q).

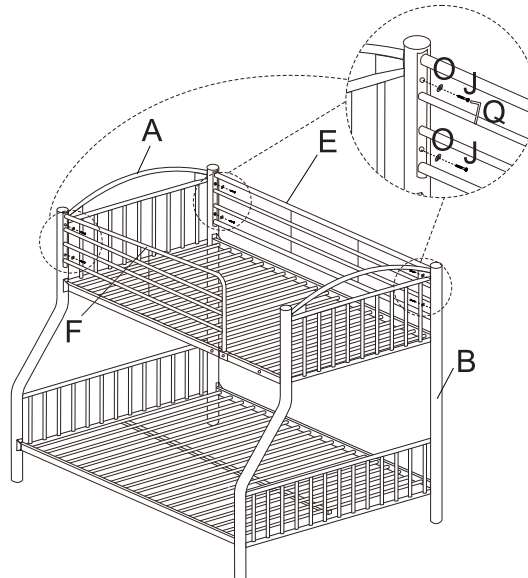

- 3** Attach Ladder Step (H) to Ladder Tube (G) using Bolt (L) and Wing Nut (T) with L-Allen Key (R).

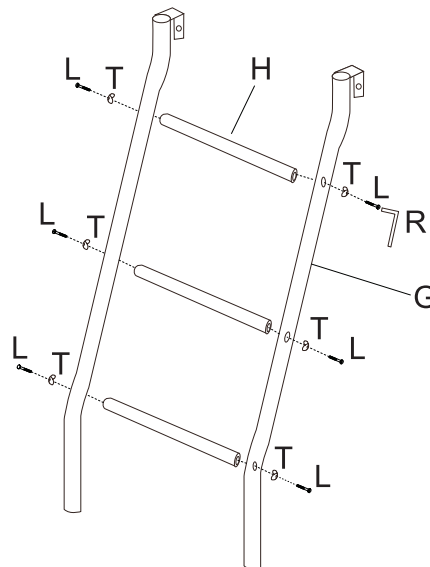

4

Attach Front Guard Rail (F) to Upper Slat Frame (C) using Bolt (L), Flat Washer (P) and Nut (M) with L-Allen Key (R) and Wrench (S). Attach Ladder to Upper Slat Frame (C) using Bolt (L) and Flat Washer (P) with L-Allen Key (R). Attach Ladder to Lower Slat Frame (D) using Bolt (I) and Flat Washer (P) with L-Allen Key (R).

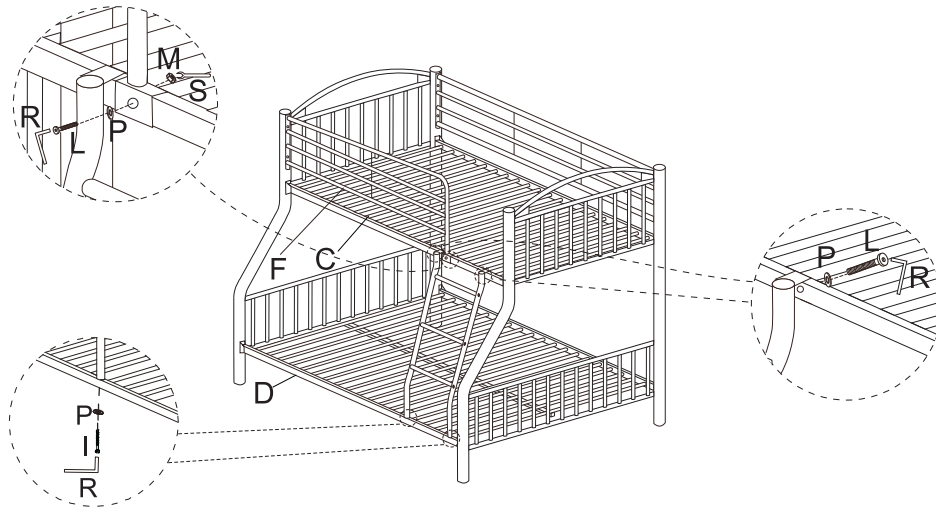

Cleaning & Care

Treat surfaces with care. Surfaces are resistant to scratches but are not scratch resistant. Clean surfaces with a dry or damp soft cloth. Do not use abrasive cleaners. Hardware may loosen over time. Periodically check that all connections are tight.

IMPORTANT NOTICE

FOR TWIN/TWIN BUNK BED:

- Use only mattress which is 74" - 75" long and 37 1/2" - 38 1/2" wide on upper bunk.
- Use only mattress which is 74" - 75" long and 37 1/2" - 38 1/2" wide on lower bunk.
- Ensure thickness of mattress does not exceed 6" and mattress surface is at least 5" below upper edge of guardrails.

FOR TWIN/FULL BUNK BED:

- Use only mattress which is 74" - 75" long and 37 1/2" - 38 1/2" wide on upper bunk.
- Use only mattress which is 74" - 75" long and 53" - 54" wide on lower bunk.
- Ensure thickness of mattress does not exceed 6" and mattress surface is at least 5" below upper edge of guardrails.

FOR FULL/FULL BUNK BED:

- Use only mattress which is 74" - 75" long and 53" - 54" wide on upper bunk.
- Use only mattress which is 74" - 75" long and 53" - 54" wide on lower bunk.
- Ensure thickness of mattress does not exceed 6" and mattress surface is at least 5" below upper edge of guardrails.

SAFETY WARNING

- Do not remove warning label from bed.
- Always use the recommended size mattress or mattress support, or both, to help prevent the likelihood of entrapment or falls.
- Surface of mattress must be at least 5" (127mm) below the upper edge of guardrails.
- Do not allow children under 6 years of age to use the upper bunk.
- Periodically check and ensure that the guardrail, ladder, and other components are in their proper position, free from damage, and that all connectors are tight.
- Do not allow horseplay on or under the bed and prohibit jumping on the bed.
- Always use the ladder for entering and leaving the upper bunk.
- Do not use substitute parts – Contact the manufacturer or dealer for replacement parts.
- Use of a night light may provide added safety precaution for a child using the upper bunk.
- Always use guardrails on both long sides of the upper bunk. If the bunk bed will be placed next to the wall, the guardrail that runs the full length of the bed should be placed against the wall to prevent entrapment between the bed and the wall.
- The use of water or sleep flotation mattress is prohibited.
- STRANGULATION HAZARD – Never attach or hang items to any parts of the bunk bed that are not designed for use with the bed; for example, but not limited to hooks, belts and jump ropes.
- Keep these instructions for future reference.