











HEKMAN[®]

A HOWARD MILLER COMPANY

27978 LIFT DESK

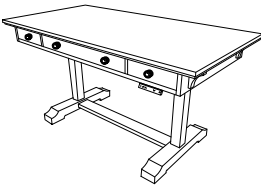
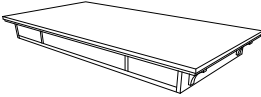
HARDWARE LIST							
A	B	C	D	E	F	G	H
ALLEN BOLT M6 X 40 (12 PCS.)	ALLEN BOLT M6 X 60 (8 PCS.)	SPRING W. M6 20 PCS.	FLAT W. M6 20 PCS.	CORD CLAMP 2 PCS.	NYLON CORD CLAMP 1 PC.	SCREW Ø6 X 1/2" 1 PC.	ALLEN KEY L4 (FOR ALLEN BOLT) 1 PC.
							

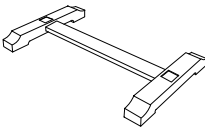
PART INSIDE			
1	2	3	
TOP ASSEMBLY (1 Pc)	METAL LEGS (2 Pcs)	WOOD LEG ASSEMBLY (1 Pc)	
			

Assembly Instruction

STEP 1.

LAY TOP ASSEMBLY OF THE TABLE DESK UPSIDE DOWN ON A SOFT, CLEAN AND FLAT SURFACE. PULL OUT DRAWERS ON SOFT MATERIAL TO PREVENT SCRATCHING SURFACES.

ALIGN METAL LEGS (2) TO THE HOLES IN THE TOP ASSEMBLY (1) AND CONNECT USING FLAT WASHER (D), SPRING WASHER (C), ALLEN BOLT (A) AND ALLEN KEY (E) PROVIDED.

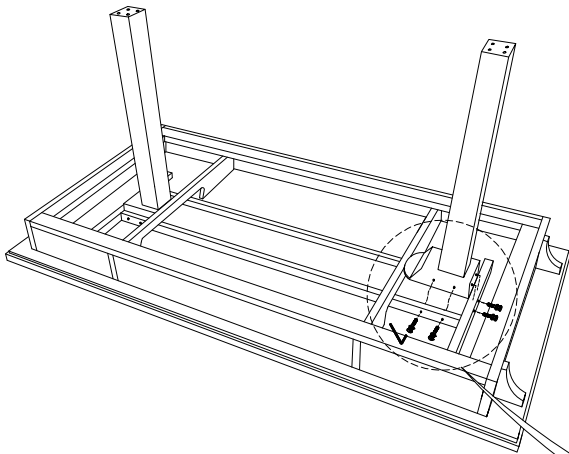

STEP 2.

PLUG THE CABLE WHICH ATTACHED ON THE LEG ONTO THE POWER SUPPLY WHICH LOCATED ON THE BOTTOM OF TOP PANEL.

