

ASSEMBLY INSTRUCTION

855C971W(3A) 3 PC PACK 24~29" H ADJUSTABLE QUARTER X -BACK CHAIR SET

A Upper 'U' Tube **B** Lower 'U' Tube **C** Leg Extension **D** Swivel **E** Ring

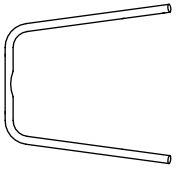

1 pc

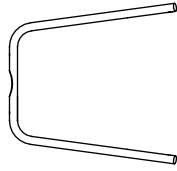

1pc

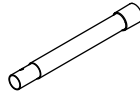

4pcs

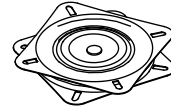

1pc

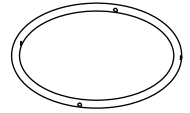

1pc

F Upper Frame **G** Seat Cushion **H** Bolt **I** Bolt **J** Bolt

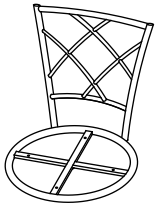

1 pc

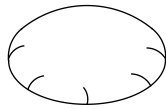

1pc

1/4", 12mm

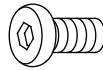

8pcs

1/4", 18mm

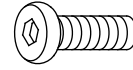

4pcs

1/4", 32mm

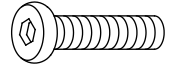

4pcs

K Screw **L** Spring Washer **M** Metal Washer **N** Allen Wrench **O** Foot Pad (Spare Part)

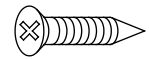

3/16", 28mm

4 pcs



8pcs

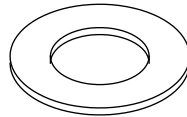

8pcs



1pc

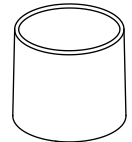

4pcs

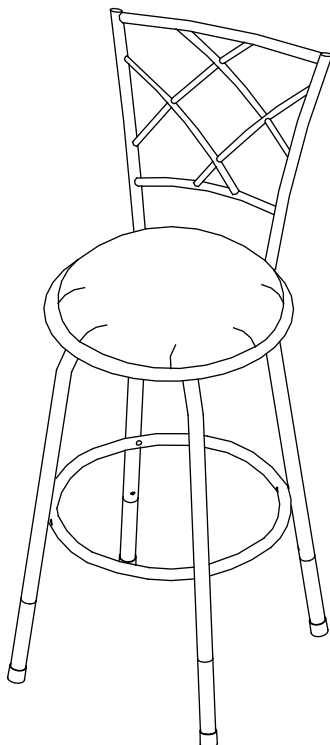

This page lists all the contents included in the box. Please take the time to identify the hardware as well as the individual components to this product. As you unpack and prepare for assembly, place the contents on a carpeted or padded area to protect them from damage.

1

(For 29 inch seat height chair) Insert Leg Extension (C) into the bottom of Upper/Lower 'U' Tube (A) & (B). Make sure Leg Extension (C) hole is aligned with the holes of Upper/Lower 'U' Tube (A) & (B), insert Bolt (H) into the lower holes, and firmly tighten using Allen Wrench (N).

***Take the Allen Wrench, and turn the bolts until the legs are secure.

DO NOT TIGHTEN COMPLETELY.

Stop when you feel you are adding force to tighten the bolt.

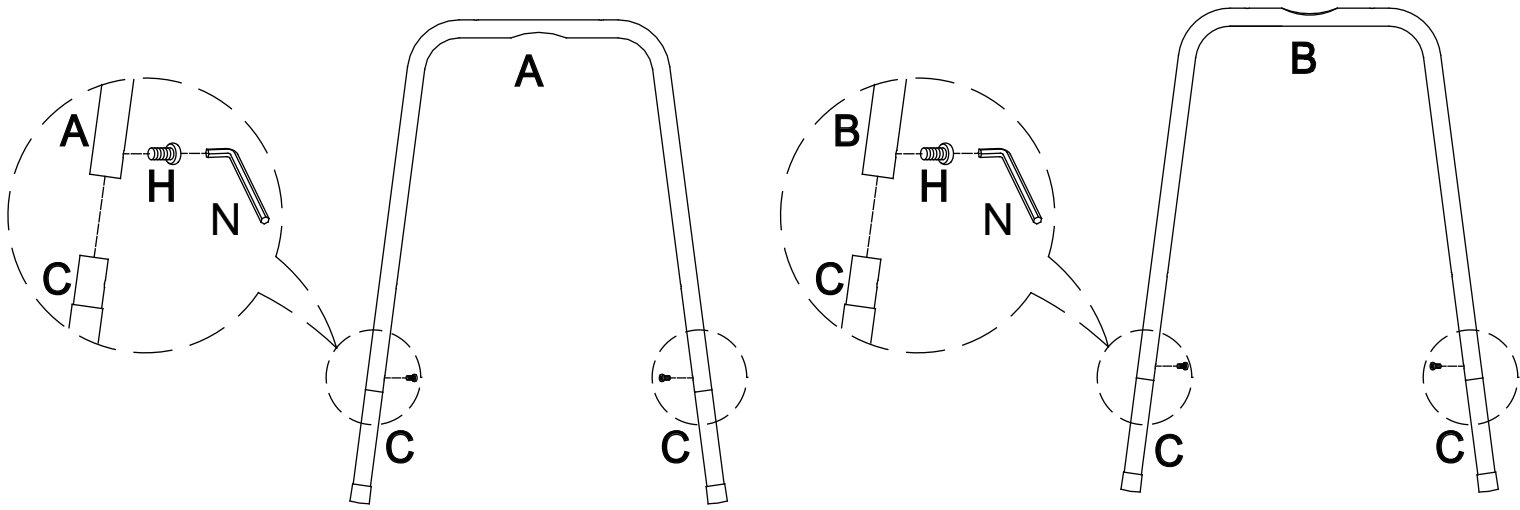
**2**

Put Upper 'U' Tube (A) into the groove of Lower 'U' Tube (B).

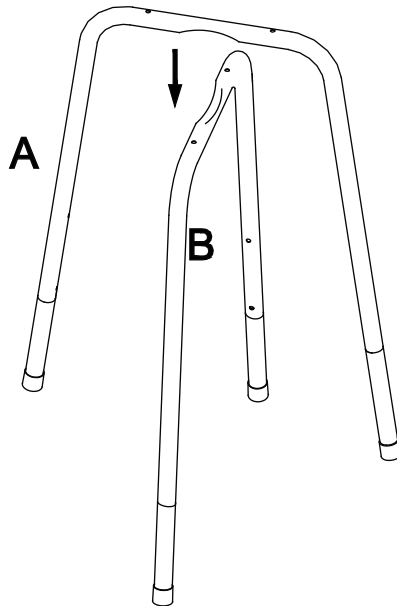

3

Turn the Swivel (D) 45 degrees (as picture shown) for easy assembly. Then put it on Upper/Lower 'U' tube (A) & (B), align the holes and firmly tighten with Bolt (I), Spring Washer (L) and Metal Washer (M) using Allen Wrench (N).

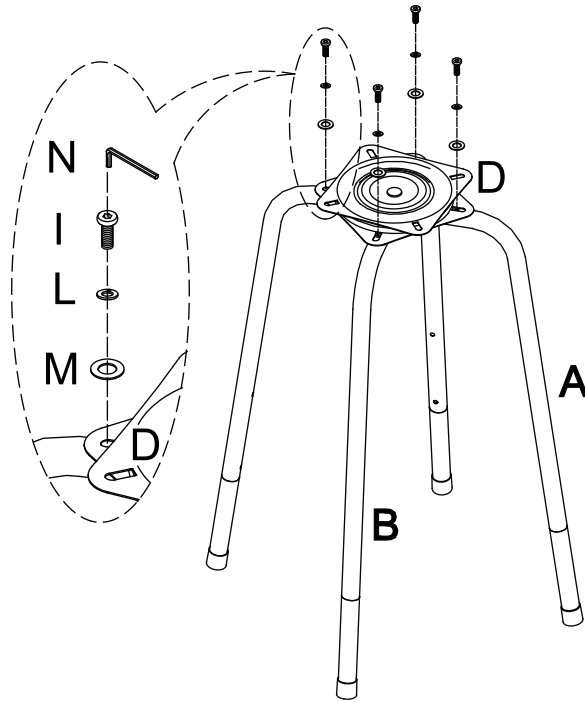
**4**

Attach Ring (E) to Upper/Lower 'U' Tube (A) & (B) and align the holes of Ring (E) with the upper holes of Upper/Lower 'U' Tube (A) & (B), then firmly tighten with Bolt (J) using Allen Wrench (N).

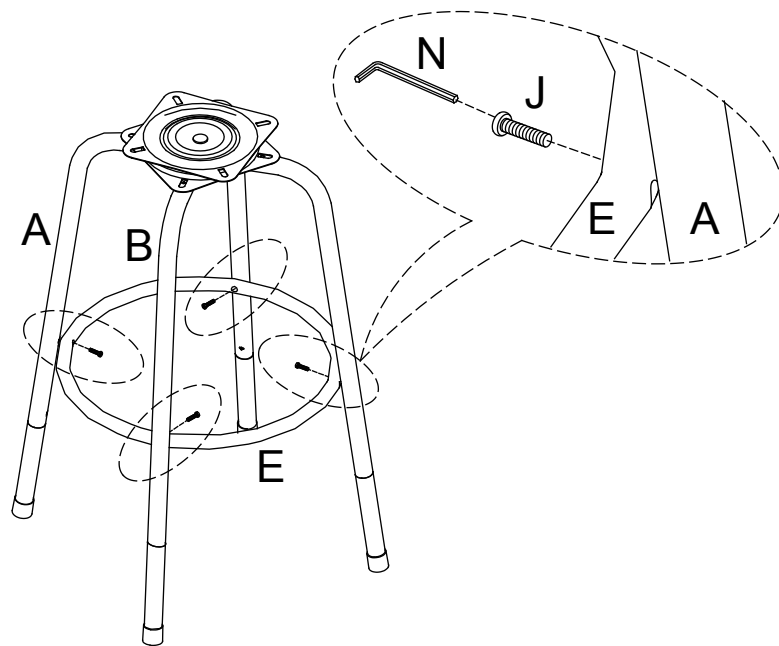

5

Put the assembled chair up-side-down on Upper Frame (F). Align holes of Swivel (D) with the holes of Upper Frame (F) and firmly tighten them with Bolt (H), Spring Washer (L) and Metal Washer (M), using Allen Wrench (N).

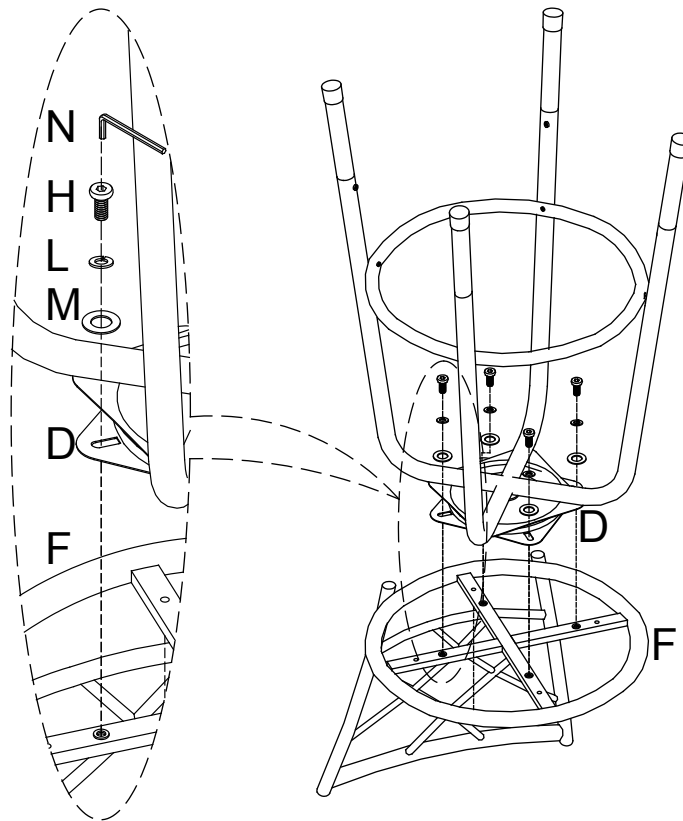
**6**

Attach Seat Cushion (G) to Upper Frame (F) with Screw (K), firmly tighten with stool (Not provided), then turn the chair upright.

Stand chair up on an even surface and check that it is balanced. If there is a slight wobble, apply downward pressure in the corner where a leg is uneven. Keeping pressure in that corner, tighten all bolts. If balanced, apply downward pressure evenly in the center and tighten all bolts. Do not over-tighten beyond hole depth.

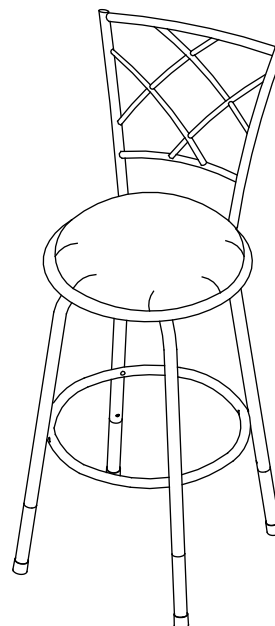
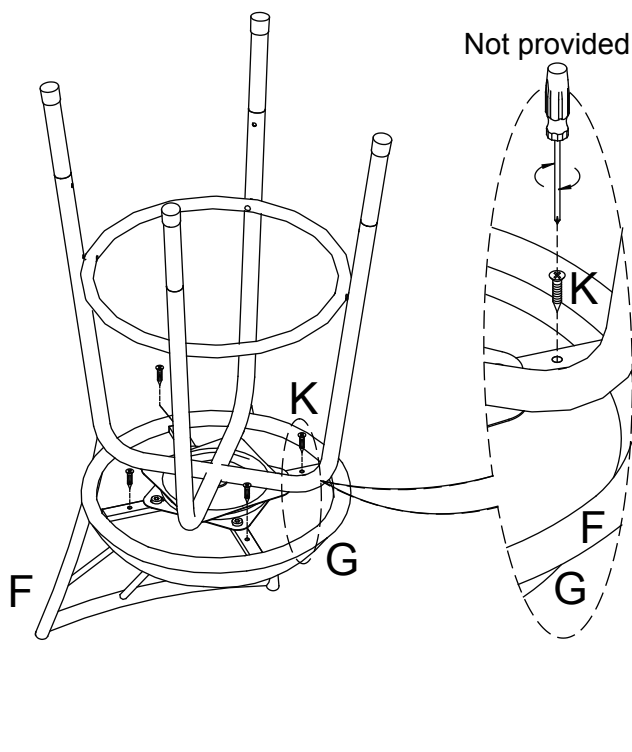

Helpful Tip:
-Instead of applying downward pressure while reaching under to tighten bolts, have someone sit in the chair while you tighten the bolts.

Cleaning & Care

Treat surface with care. Surface is resistant to scratches but is not scratch resistant. Clean surfaces with a dry or damp soft cloth. Do not use abrasive cleaners. Hardware may loosen over time. Periodically check that all connections are tight.