

ASSEMBLY INSTRUCTION

2020FBK-1(3A)/ 2020QBK-1(3A) AVERNY BLACK METAL FULL/ QUEEN PLATFORM BED

A LSF Headborad Post  1PC	B RSF Headborad Post  1PC	C LSF Footborad Post  1PC	D RSF Footborad Post  1PC
E Headboard/ Footboard  2PCS	F Rail Section(1)  2PCS	G Rail Section(2)  2PCS	H Rail Support Leg  2PCS
I Front Support Bar  2PCS	J Center Support Bar  1PC	K Front Center Rail  1PC	L Rear Center Rail  1PC
M Center Support Leg  3PCS	N Slat  16PCS	O Slat Connector  32PCS	P Finial  4PCS
Q Bolt 1/4"*13mm  30PCS	R Bolt 1/4"*36mm  10PCS	S Nut 1/4"  6PCS	T L-Allen Key 4mm  1PC
U Wrench  1PC			

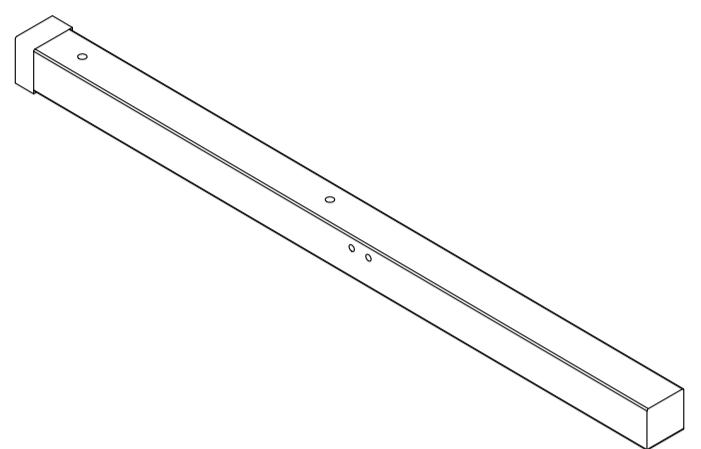
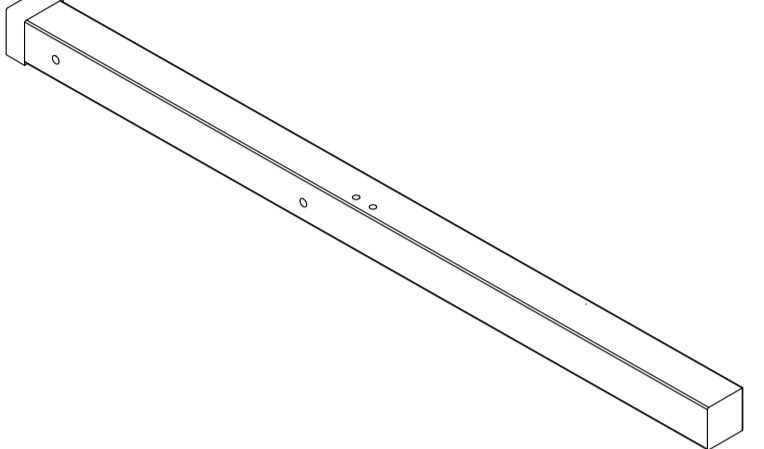
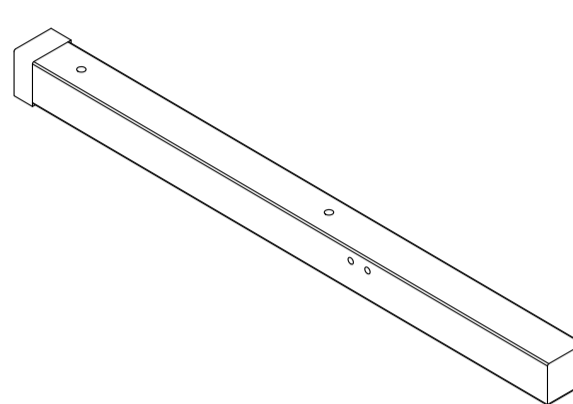
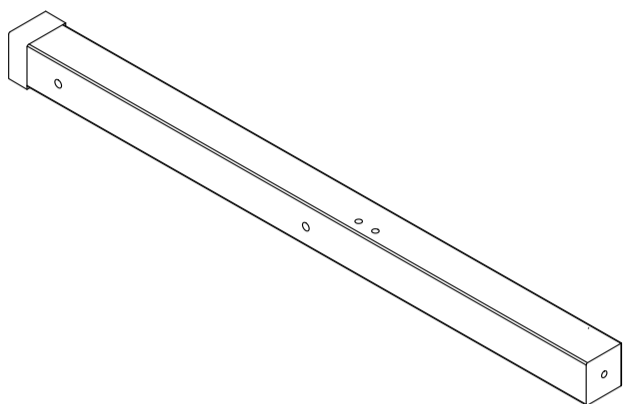
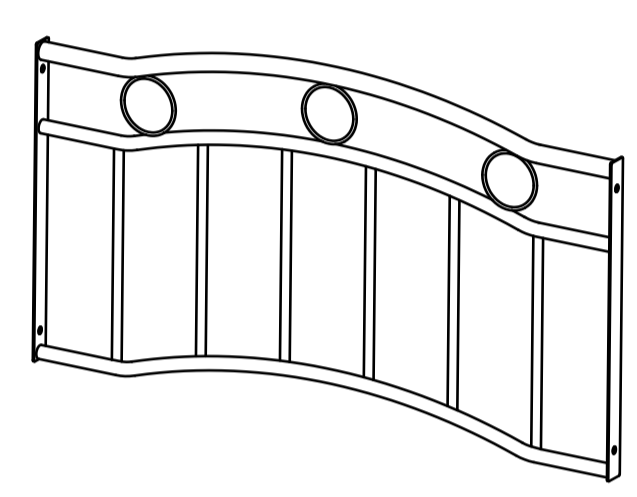
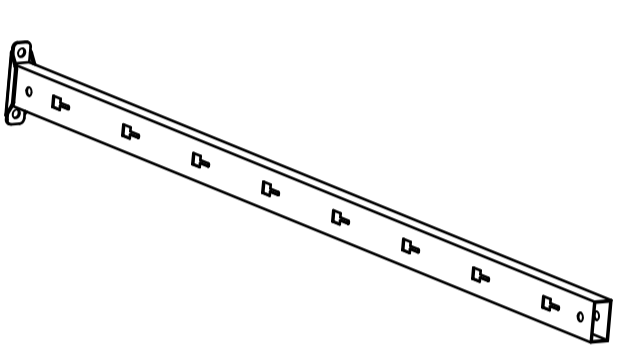
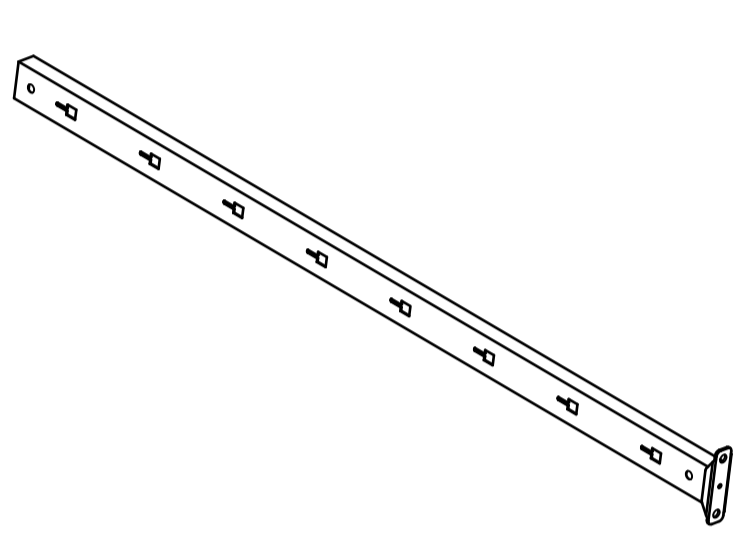
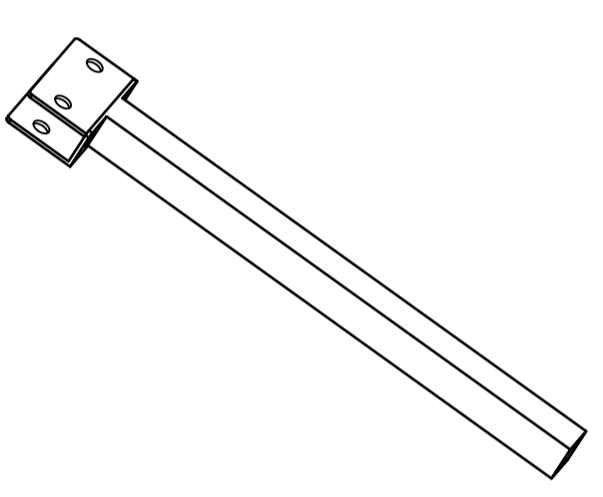
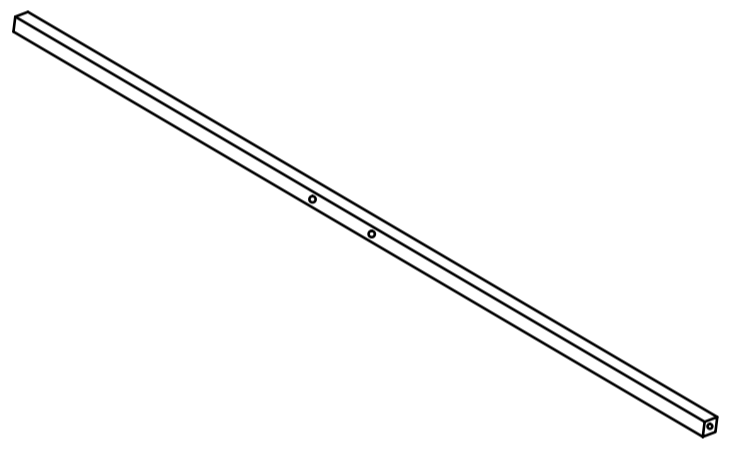
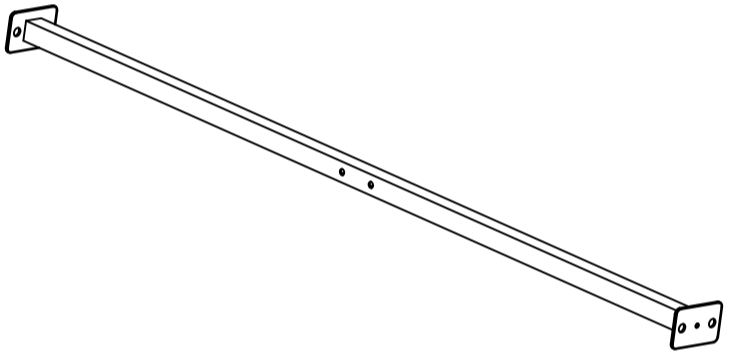
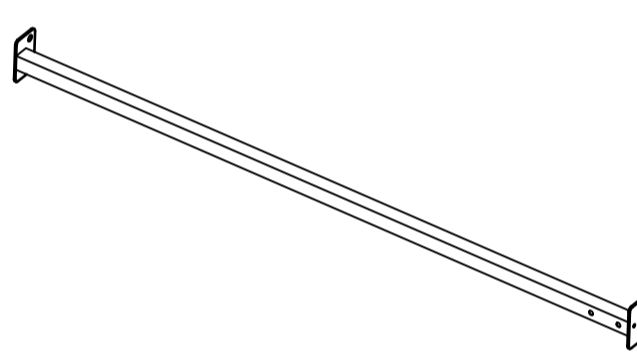
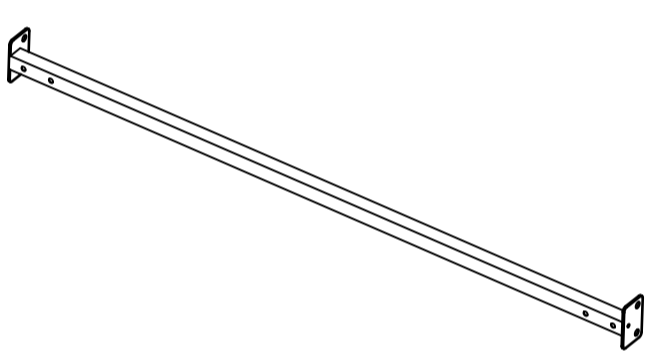
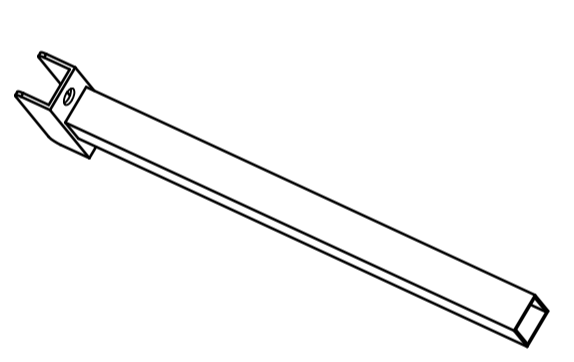
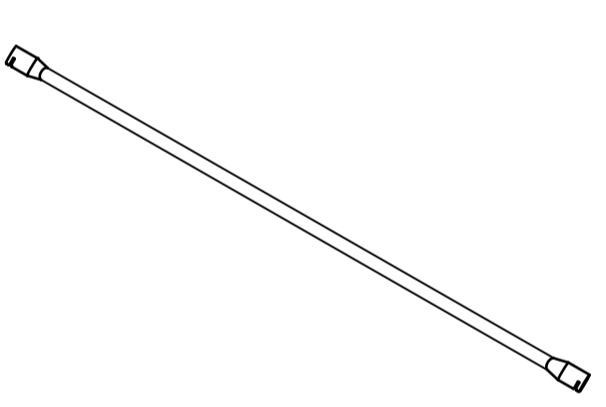
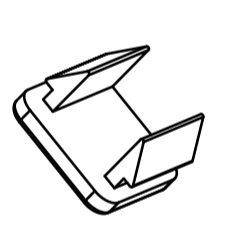
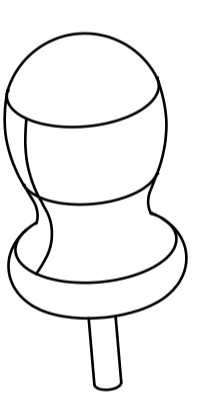
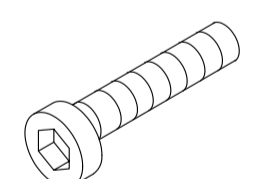
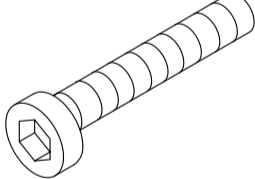
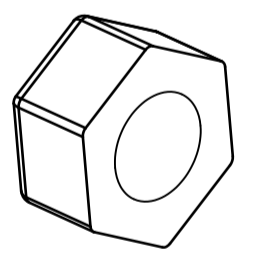
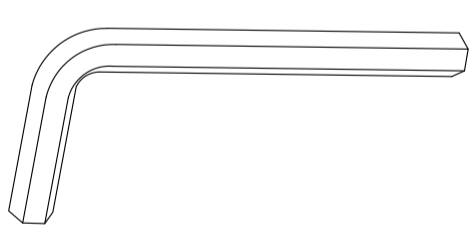
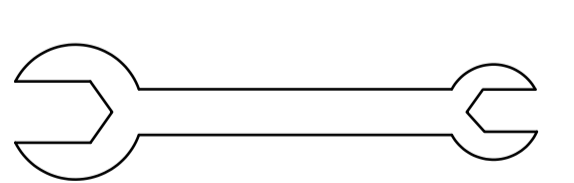
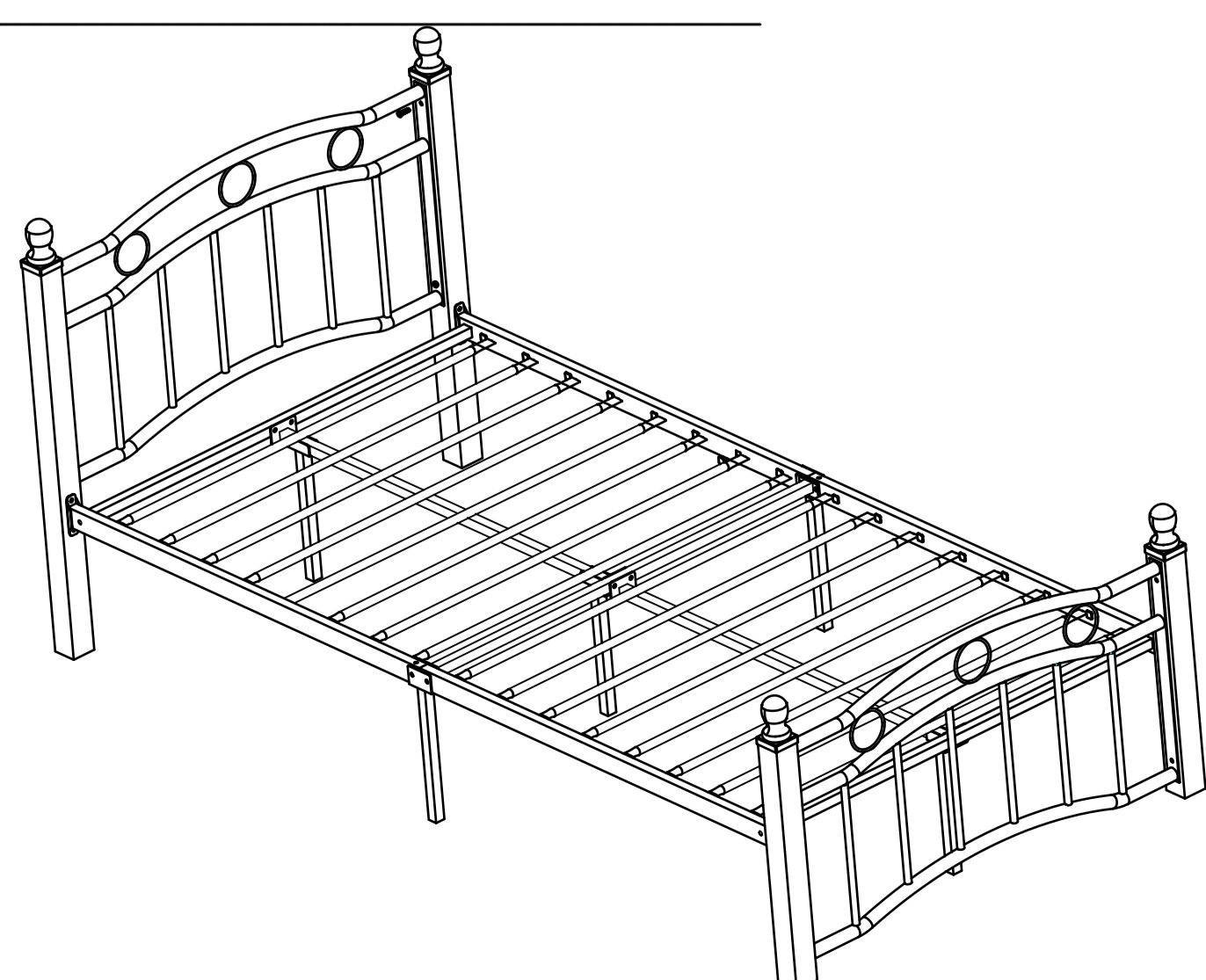

This page lists all the contents included in the box. Please take the time to identify the hardware as well as the individual components to this product. As you unpack and prepare for assembly, place the contents on a carpeted or padded area to protect them from damage.

1

Align the LSF Headboard Post(A) and RSF Headboard Post(B) to the Headboard/Footboard(E), insert the Bolt(Q) to the holes, turn the L-Allen Key(T) to tighten them. Align the LSF Footboard Post(C) and RSF Footboard Post(D) to the Headboard/Footboard(E), insert the Bolt(Q) to the holes, turn the L-Allen Key(T) to tighten them.

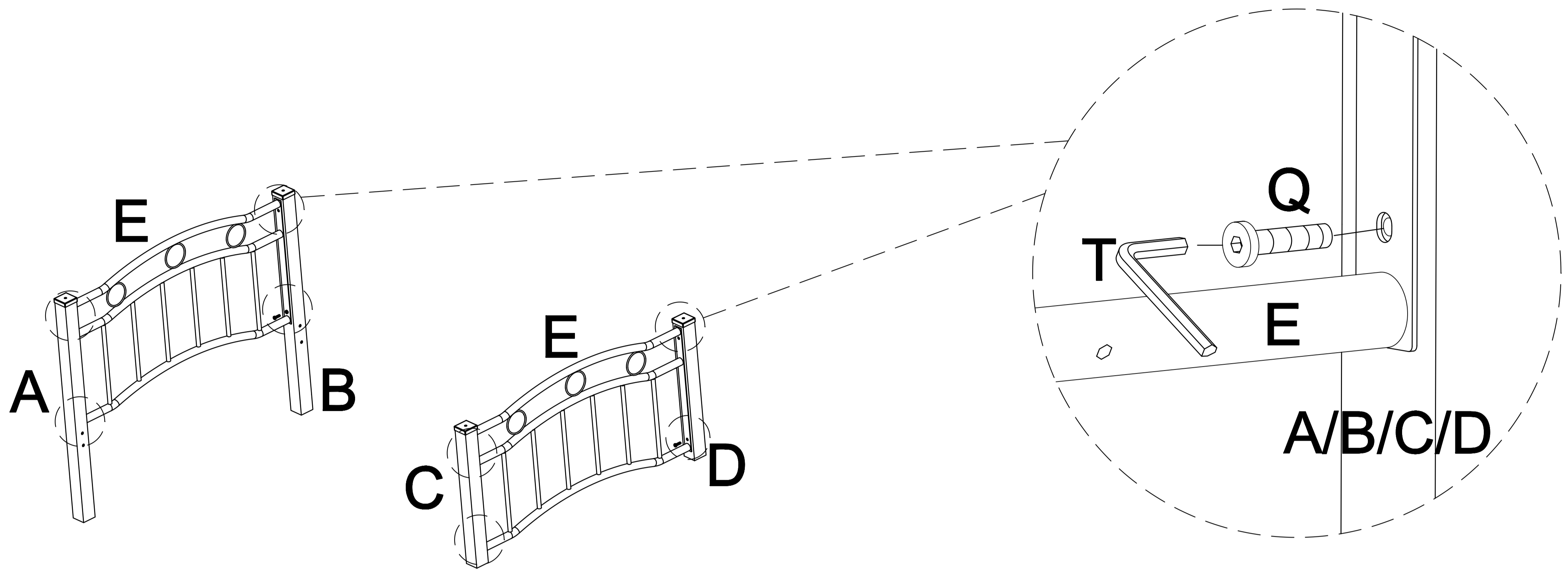
**2**

Attach the Rail Section(1)(F), the Rail Section(2)(G) to the Headboard/Footboard(E), insert the Bolt(Q), turn the L-Allen Key(T) to tighten them. Attach the Rail Support Leg(H) to the rail, insert the Bolt(Q), turn the L-Allen Key(T) to tighten them.

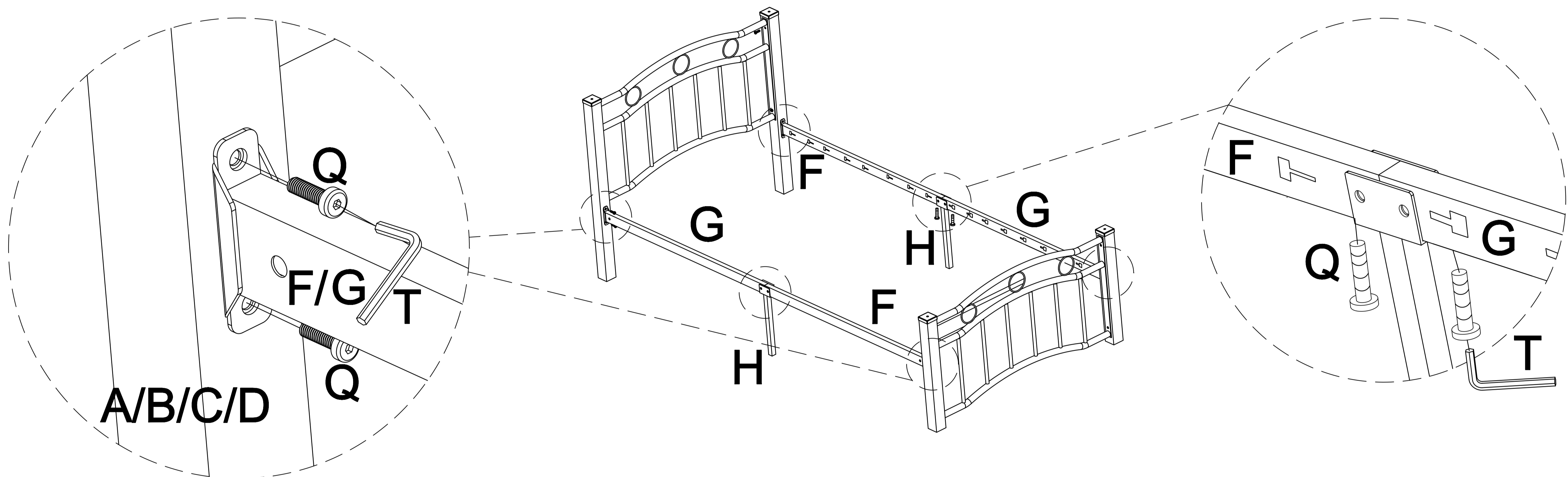
**3**

Attach the Front Support Bar(I) to the rail, insert the Bolt(R), turn the L-Allen Key(T) to tighten them. Then attach the Center Support Bar(J) to the rail, insert the Bolt(R) and the Nut(S), turn the L-Allen Key(T) and Wrench(U) to tighten them.

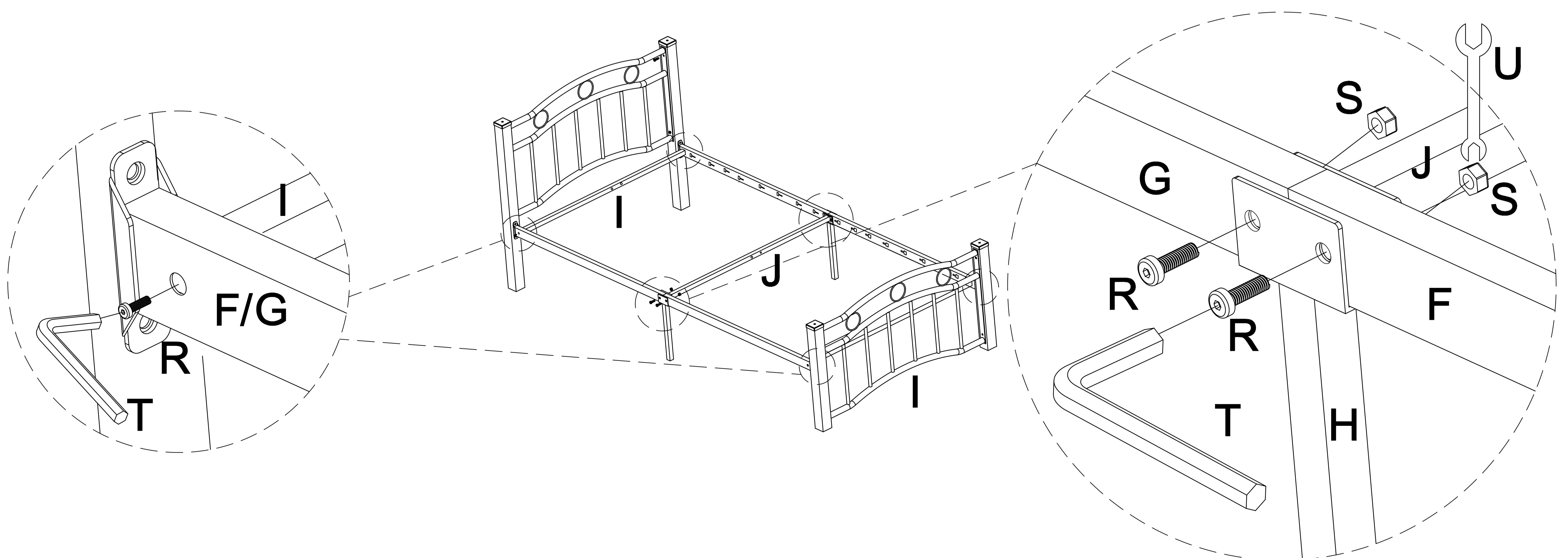

4

Attach the Front Center Rail(K) and Rear Center Rail(L) to the Support Bar(I)(J), insert Bolt(Q), turn the L-Allen Key(T) to tighten them. Attach the Center Support Leg(M) to the Center Rail(K)(L), insert Bolt(Q), Bolt(R) and Nut(S), turn the L-Allen Key(T) and Wrench(U) to tighten them.

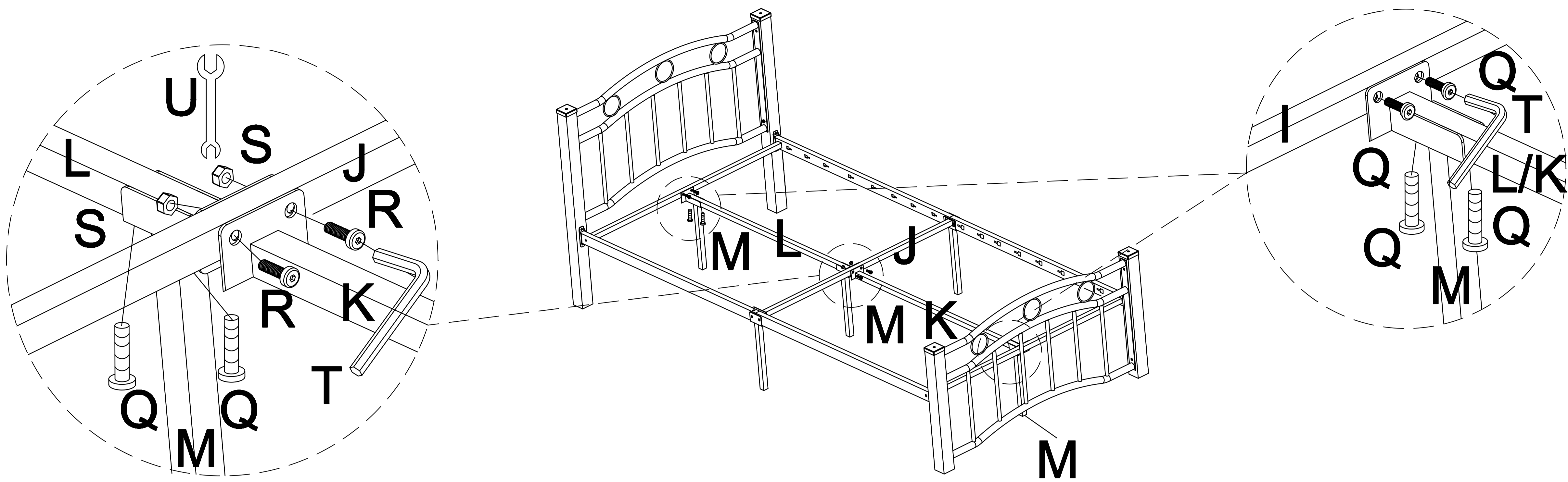

5

Attach the Finial(P) to the post, then tighten it.

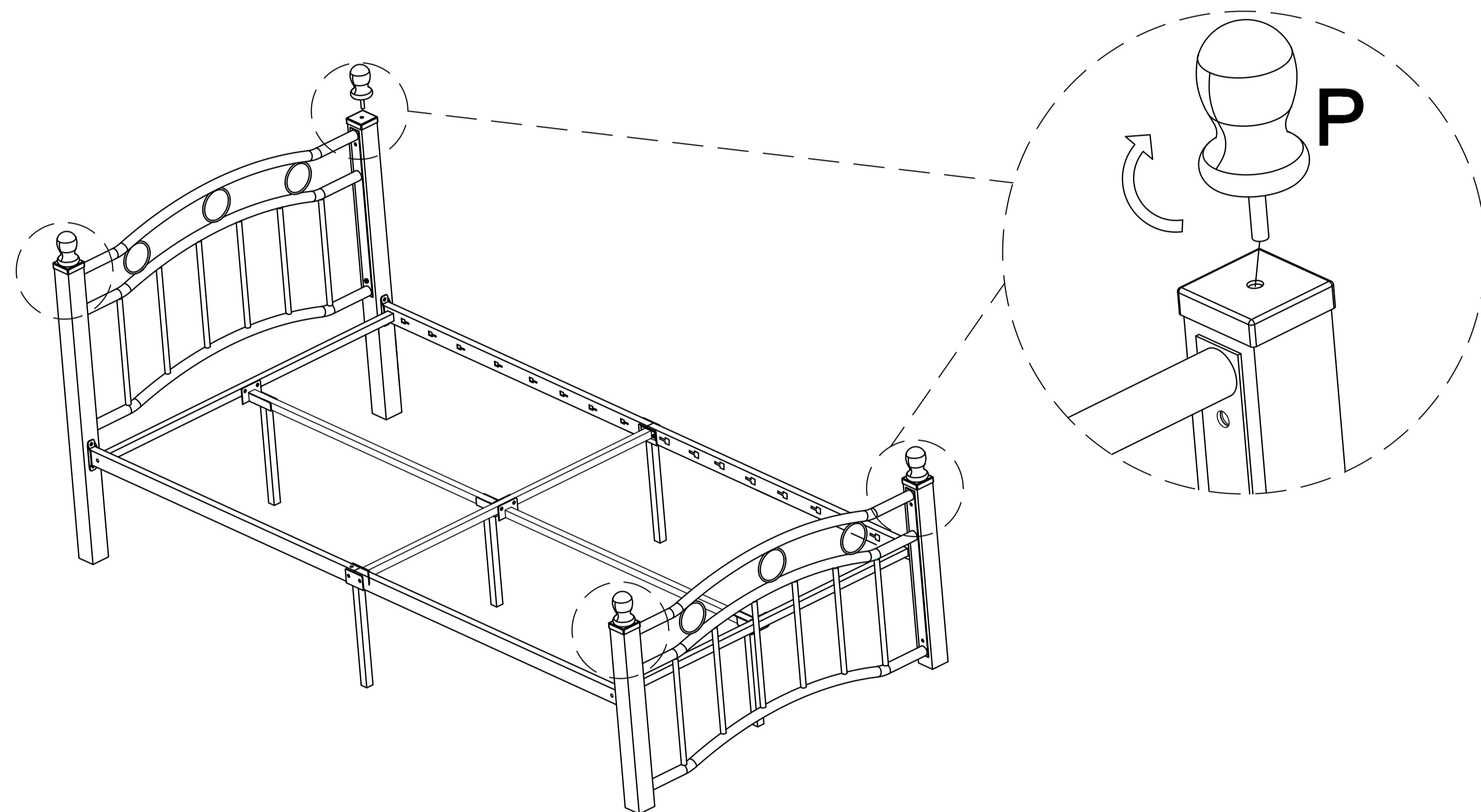

6

Attach the Slat(N) and the Slat Connector(O) to the rail, then tighten it.

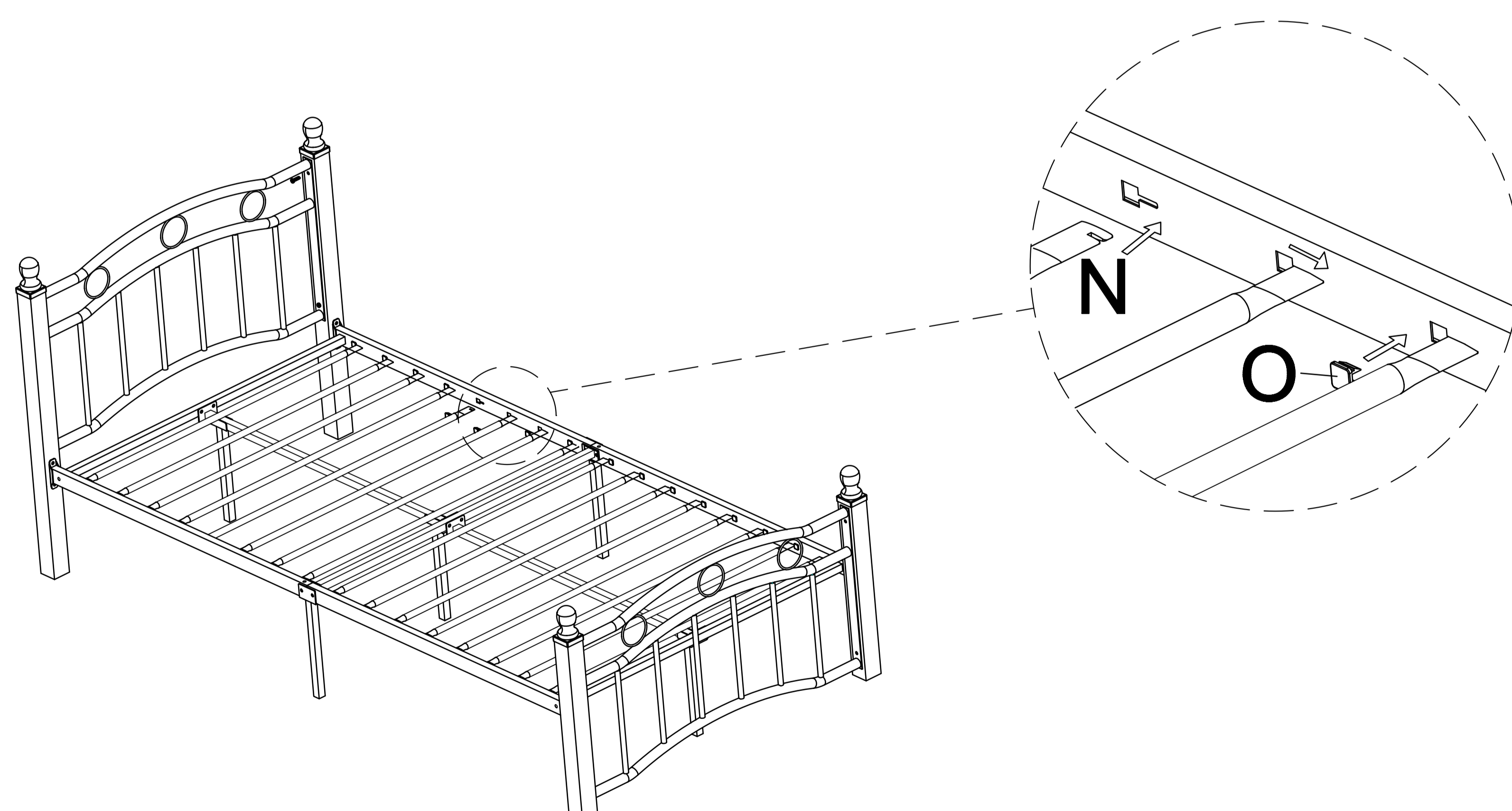

Cleaning & Care

Treat surface with care. Surface is resistant to scratches but is not scratchresistant. Clean surfaces with a dry or damp soft cloth. Do not use abrasive cleaners. Hardware may loosen over time. Periodically check that all connections are tight.