

Installation and Care Guide

Steam Adapter Kit / Steam Head for DTV+

Français, page "Français-1"
Español, página "Español-1"

THE BOLD LOOK
OF **KOHLER**®

1235393-2-E

IMPORTANT INSTRUCTIONS

IMPORTANT SAFETY INFORMATION



WARNING: When using this unit, basic precautions should always be followed:



DANGER: Risk of electrocution. Disconnect the electricity to the working area at the main breaker panel before performing these installation steps.



WARNING: Risk of personal injury. If you become uncomfortable while taking a steambath, you should turn off the unit. Cool off with the shower, open the door, or exit the unit.



WARNING: Risk of allergic reaction. Before adding any oils, aromatic therapies, or skin care products to the aromatherapy well, make sure they will not cause an allergic reaction to the user.



WARNING: Risk of personal injury. This steambath may not be suitable for use if you are pregnant, have a heart condition, have high blood pressure, have circulatory problems, are under the influence of alcohol, are taking drugs or are under the care of a physician. A steambath can put undue stress on the body, as does any hot bath, shower, or sauna.



WARNING: Risk of personal injury. DO NOT consume alcoholic beverages or take medications/drugs before or when using the steambath. Alcohol and drugs affect mental judgment, greatly increase the risk of hyperthermia, and inhibit bodily functions such as heartbeat and respiration, resulting in potentially dangerous effects.



WARNING: Risk of injury to children. Do not allow children to use this unit unless they are closely supervised at all times. The steam generator is not designed to be used by children.



WARNING: Risk of scalding or burning. Stay away from the steam head during operation. The steam head is hot during operation.



WARNING: Risk of personal injury or property damage. Avoid coming in contact with the water tank and/or steam

IMPORTANT INSTRUCTIONS (cont.)

discharge line while the steam generator is operating or shortly after shutdown. Wear eye protection and protective clothing when servicing the steam generator. The steam generator operates at high temperatures.

NOTICE: Use this unit only for its intended use as specified in this manual. **DO NOT** use attachments not recommended by Kohler Co.

NOTICE: Follow all plumbing, electrical, and building codes.

Operation with DTV+

- To connect the steam adapter to the DTV+ system, the K-99695 system controller is required.
- The provided data cable is used to connect the steam adapter to the system controller.
- Refer to the "DTV+ System Layout" section in this guide.

Before Operating the System for the First Time:

Download and install the latest software for connected components. This may take an hour or more to complete based on system configuration and internet connection speed. **Do not disconnect the power from any component during software download and installation.**

Tools and Materials

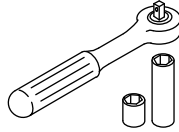
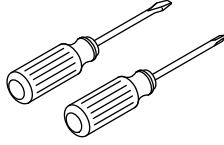
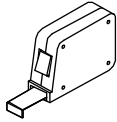
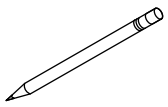

Socket Wrench
with 1" Socket

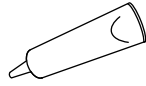
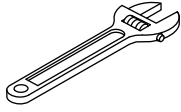
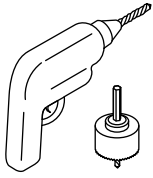

Dielectric Grease

Drill w/ 3/8", 7/16", & 2-1/2"
Hole Saw (match hole saw
to wall material)



Sealant
Tape

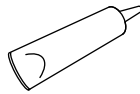

100% Silicone
Sealant

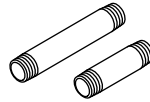

Pipe Nipples

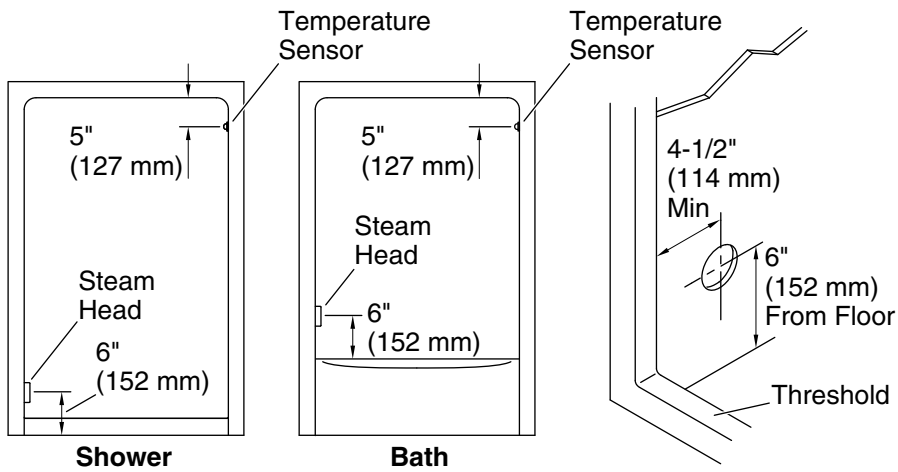

Before You Begin



WARNING: Risk of personal injury. A user interface must be located within the steam enclosure to allow temperature regulation and control of the steam flow.



CAUTION: Risk of scalding. Do not locate the steam head near a seat or bench, as the steam head is hot during operation and may scald the user if touched.

NOTICE: Do not locate the user interface on the same wall as the steam head(s).

NOTICE: The temperature sensor must be located on the wall opposite the steam head(s).

- If possible install the steam generator(s) and K-99695 system controller before beginning this installation.
- Locate the steam head 6" (152 mm) above the floor and 4-1/2" (114 mm) from the inside of the threshold.
- If two steam heads are used, there must be at least 12-1/2" (318 mm) between the center of each hole. The steam heads do not need to be located in the same area.
- Locate the steam head(s) as far away as possible from any shower seating area.
- Locate the temperature sensor on the wall 5" (127 mm) down from the ceiling.

Before You Begin (cont.)

- Make sure that there is adequate clearance between the steam lines and any surrounding surfaces, or apply appropriate insulation to the steam lines.

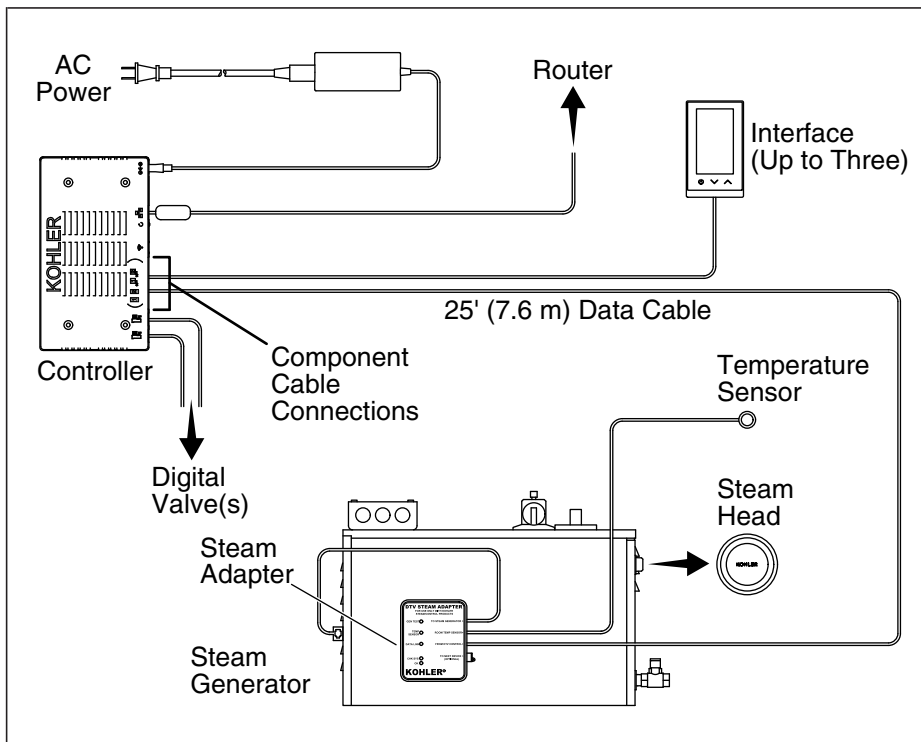

1. DTV+ System Layout

The K-99695 system controller powers the interface(s) and controls the steam generator and other system components.

- Determine the locations of all required components.
- A 25' (7.6 m) data cable is provided to connect the steam adapter to the controller. If the steam generator is not within 25' (7.6 m) of the controller, add a telephone-style extension cable.

Before Operating the System for the First Time:

Download and install the latest software for connected components. This may take an hour or more to complete based on system configuration and internet connection speed. **Do not disconnect the power from any component during software download and installation.**

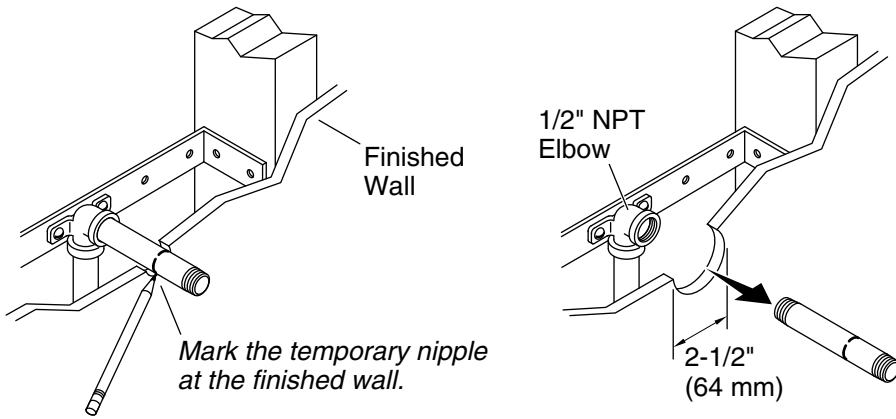

2. Prepare the Site

NOTE: This section continues the installation described in the steam generator installation instructions. Refer to the steam generator installation instructions for more information, as needed.

NOTE: If two steam heads are used, there must be at least 12-1/2" (318 mm) between the center of each hole. The steam heads do not need to be located on the same wall. Install two steam heads on different walls to improve steam distribution.

- Install the finished wall.
- Drill or cut a 2-1/2" (64 mm) hole centered around the elbow in the wall.
- Mark the temporary pipe nipple at the finished wall surface.
- Remove the temporary pipe nipple from the elbow.

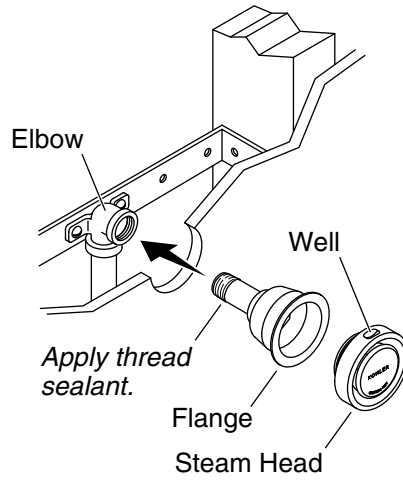
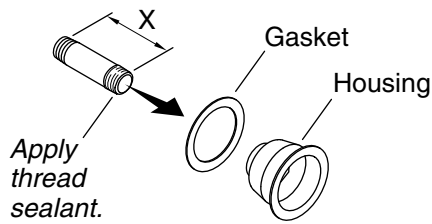
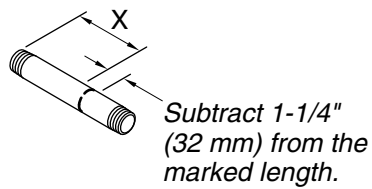

3. Install the Steam Head(s)

NOTICE: Do not obstruct the steam head with shut-off valves, plugs, or caps.

- Subtract 1-1/4" (32 mm) from the marked length on the temporary nipple to determine the appropriate nipple size.
- Choose a nipple length within 1/8" (3 mm) of the appropriate size.
- Apply thread sealant to one end of the nipple and thread into the housing until hand tight.
- Apply thread sealant to the other end of the nipple.
- Position the gasket onto the housing so it will sit between the finished wall and the housing flange.
- Use a 1" socket to thread the housing into the elbow.
- Make sure that the gasket is compressed to achieve a good seal around the housing.
- If needed, use an appropriate sealant to achieve a watertight seal.
- Press the steam head into the housing with the well positioned at the top.

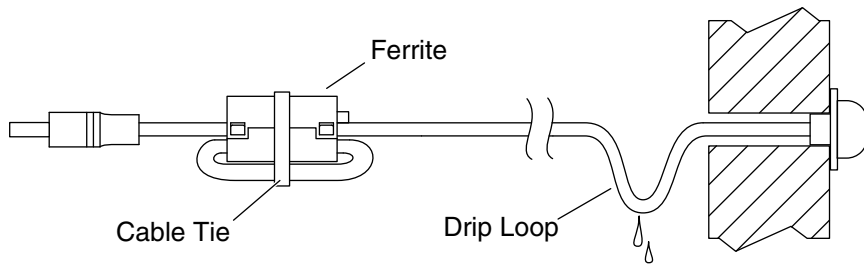
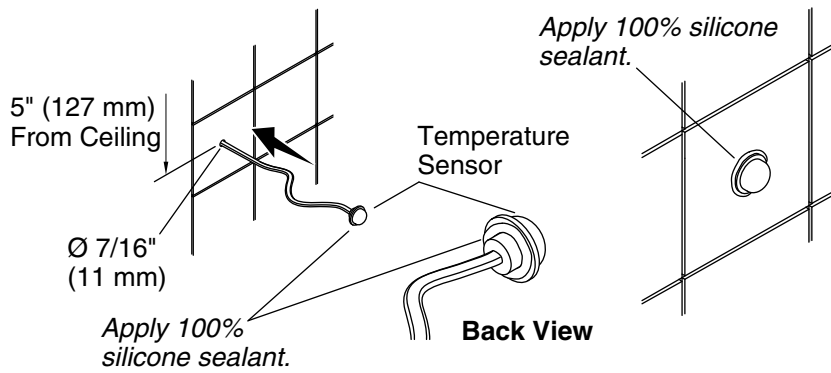

4. Install the Temperature Sensor

IMPORTANT! Do not locate the temperature sensor directly above the steam head. Locate the temperature sensor on the wall opposite the steam head.

IMPORTANT! Make a drip loop in the temperature sensor wire to prevent moisture from following the wire to the steam generator.

- ❑ Make sure that the power is turned off at the main breaker panel before proceeding.
- ❑ Locate the temperature sensor on the wall 5" (127 mm) down from the ceiling, on the wall opposite the steam head.
- ❑ Drill a 7/16" hole at the selected location.

IMPORTANT! Do not pinch, nail, wedge, or use undue force when handling the sensor wire. Any damage may result in temperature sensor failure.

- ❑ Insert the temperature sensor wire through the drilled hole.
- ❑ Route the wire behind the wall to the steam generator location.

Install the Temperature Sensor (cont.)

- Apply a small bead of 100% silicone sealant to the back of the sensor housing. Do not let any sealant contact the sensor probe.
- Press the sensor firmly onto the wall.
- Temporarily secure the sensor in place with tape.
- Allow the sealant to cure before use.
- Loop the cable through the ferrite on the adapter end of the cable, and snap the ferrite closed. Use the cable tie provided to encircle and lightly secure the looped cable and ferrite.

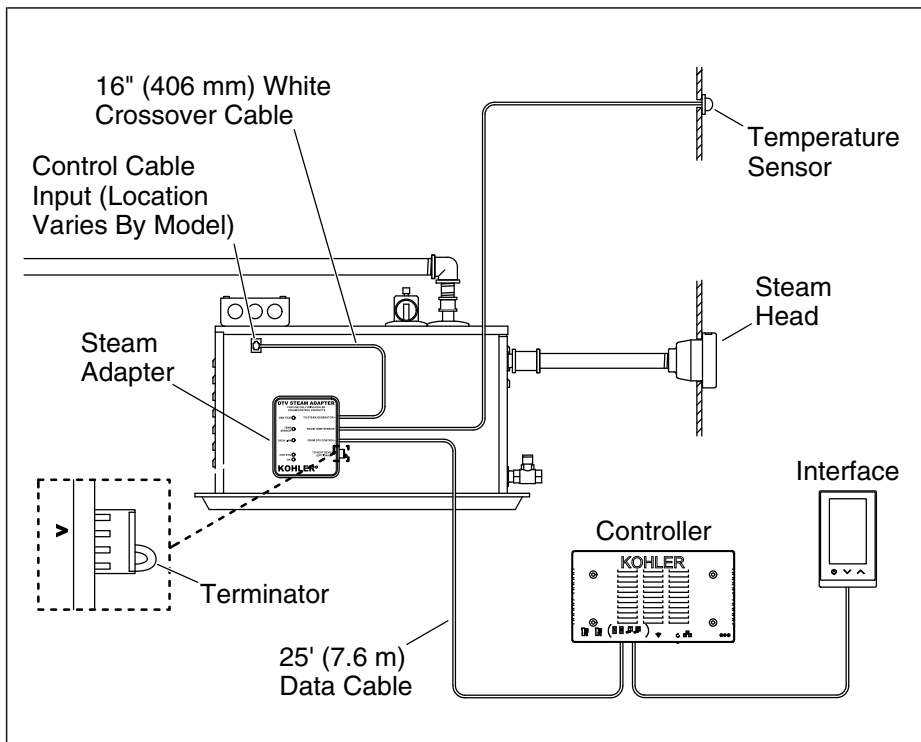

5. Install the Adapter – Single Steam Head

- Remove the adhesive backing from the steam adapter.
- Mount the adapter firmly to the side of the steam generator.

NOTICE: Do not pinch, nail, wedge, or use undue force when handling the silver crossover cable. Any damage may result in adapter failure. If the adapter is not installed immediately, protect the cable ends with tape or other shielding material.

NOTE: The terminator should be installed if no additional equipment is to be added in series to this device. If additional equipment is to be connected downstream of this device, remove the terminator and follow the instructions packed with the additional equipment.

- Apply dielectric grease in all the connectors and wires.
- Connect the 16" (406 mm) white crossover cable to the steam adapter and the steam generator.
- Connect the temperature sensor wire to the corresponding port on the steam adapter.

Install the Adapter – Single Steam Head (cont.)

- Connect the data cable to the steam adapter and route the cable to the controller installation location.

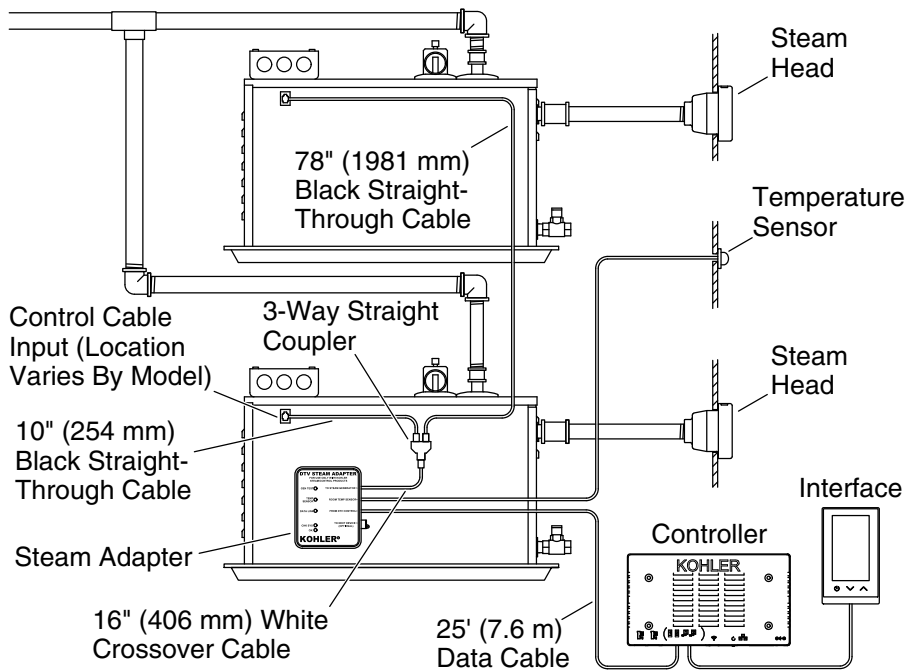

6. Install the Adapter – Dual Steam Head

- Remove the adhesive backing from the steam adapter.
- Mount the adapter firmly to the side of the steam generator.

NOTICE: Do not pinch, nail, wedge, or use undue force when handling the white crossover cable. Any damage may result in adapter failure. If the adapter is not installed immediately, protect the cable ends with tape or other shielding material.

NOTE: The terminator should be installed if no additional equipment is to be added in series to this device. If additional equipment is to be connected downstream of this device, remove the terminator and follow the instructions packed with the additional equipment.

- Apply dielectric grease in all the connectors and wires.
- Connect the 16" (406 mm) white crossover cable to the steam adapter and the inlet side of the 3-way coupler.
- Connect the 10" (254 mm) black straight-through cable to the output side of the 3-way coupler and the first generator.

Install the Adapter – Dual Steam Head (cont.)

- Connect the 78" (1981 mm) black straight-through cable to the output side of the 3-way coupler and the second generator.
- Connect the temperature sensor wire to the corresponding port on the steam adapter.
- Connect the data cable to the steam adapter and route the cable to the controller installation location.

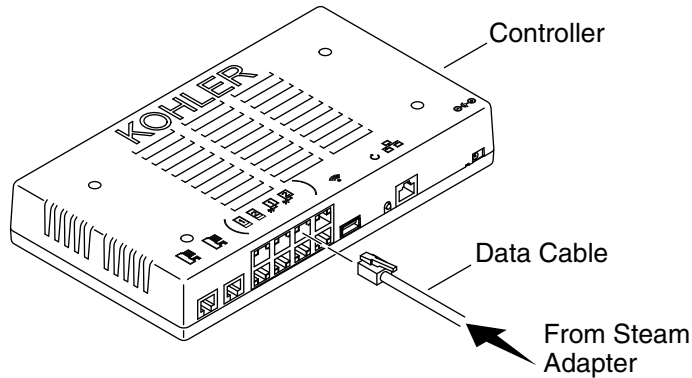

7. Complete the Installation

- If not already installed, install the K-99695 system controller according to the instructions packed with the product.
- Apply dielectric grease in the connector.
- Connect the data cable into one of the eight grouped component ports on the controller.
- Turn on the water supply.
- Restore the power at the main breaker panel.
- For information on system setup and operation, refer to the guide on the controller product page at us.kohler.com.

Before Operating the System for the First Time:

Download and install the latest software for connected components. This may take an hour or more to complete based on system configuration and internet connection speed. **Do not disconnect the power from any component during software download and installation.**

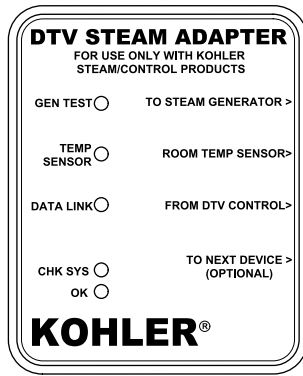

Operation

Status LED Lights

- "GEN TEST" = steam generator connection/function.
- "TEMP SENSOR" = temperature sensor connection/function.
- "DATA LINK" = data cable connection/function.

Normal Operation

- Each of the main LEDs ("GEN TEST," "TEMP SENSOR," and "DATA LINK") blinks green once every second (1 second ON, 1 second OFF).

Abnormal Operation

- One or more of the main LED status lights ("GEN TEST," "TEMP SENSOR," and "DATA LINK") is OFF, ON flashing red, ON solid green, or ON solid red.
- Refer to the "Troubleshooting" section for more information.

Power Clean Function



WARNING: Risk of personal injury. Steam room temperature will be extremely high when the power clean function is activated. **Do not** enter the steam room while the power clean function is in progress.

NOTICE: Users will be automatically reminded to use power clean after 600 minutes of steam generator use. The steam generator may be run three more times before the power clean function must be run. Failure to initiate power clean after the third reminder will result in the system locking. Power clean must be run to resume steam operation.

Operation (cont.)

NOTE: When the power clean function is activated, water will discharge from the steam head.

Care and Cleaning

For best results, keep the following in mind when caring for your KOHLER product:

- Always test your cleaning solution on an inconspicuous area before applying to the entire surface.
- Wipe surfaces clean and rinse completely with water immediately after applying cleaner. Rinse and dry any overspray that lands on nearby surfaces.
- Do not allow cleaners to soak on surfaces.
- Use a soft, dampened sponge or cloth. Never use an abrasive material such as a brush or scouring pad to clean surfaces.

For detailed cleaning information and products to consider, visit www.kohler.com/clean. To order Care & Cleaning information, call 1-800-456-4537.

Troubleshooting

NOTE: For DTV+ system troubleshooting, refer to the guide on the K-99695 controller product page at us.kohler.com.

NOTE: For service parts information, visit your product page at kohler.com/serviceparts.

This troubleshooting guide is for general aid only. For service and installation issues and concerns, call 1-800-4KOHLER.

Symptoms	Probable Causes	Recommended Action
1. Error 0140 is displayed.	A. Tank water level is too low (green status light on steam generator is on).	A. Inspect the water inlet screen and clean if necessary. Ensure that the water supply valve is on and that water is being supplied to the steam generator.

Troubleshooting (cont.)		
Symptoms	Probable Causes	Recommended Action
	<p>B. Tank temperature limit has been exceeded (green status light on steam generator is off).</p> <p>C. Internal steam generator components are not functioning properly.</p>	<p>B. Call the Customer Care Center using the information provided on the back page of this manual.</p> <p>C. Call the Customer Care Center using the information provided on the back page of this manual.</p>
2. Error 0120 is displayed.	<p>A. The temperature in the steam room has exceeded the maximum allowable level.</p>	<p>A1. Reset power to the steam generator and ventilate the steam room to remove excess heat.</p> <p>A2. Relocate the temperature sensor away from the steam head or other heat source.</p> <p>A3. Call the Customer Care Center using the information provided on the back page of this manual.</p>
3. Error 0104 is displayed.	<p>A. Temperature sensor not connected.</p> <p>B. Temperature sensor is damaged.</p>	<p>A. Connect the temperature sensor.</p> <p>B. Call the Customer Care Center using the information provided on the back page of this manual.</p>
4. Error 0408 is displayed.	<p>A. A communication error has occurred.</p>	<p>A. Perform a system reset on the user interface.</p>
5. Lights on the adapter are off.	<p>A. Inadequate power is supplied to the steam generator (green status light on steam generator is off).</p>	<p>A. Provide proper power to the steam generator. If necessary, use the provided test kit to ensure that the steam generator is working properly.</p>

Troubleshooting (cont.)		
Symptoms	Probable Causes	Recommended Action
	<p>B. The user interface is not receiving power from the steam generator (green status light on the steam generator is on).</p>	<p>B. Use the provided test kit and instructions to identify the source of the problem.</p>
	<p>C. The user interface is damaged (green status light on the steam generator is on).</p>	<p>C. Call the Customer Care Center using the information provided on the back page of this manual.</p>
<p>6. "GEN TEST" light is blinking red.</p>	<p>A. An error has occurred with the steam generator.</p>	<p>A. Check the error code on the user interface. See the corresponding error code in this document.</p>
<p>7. "TEMP SENSOR" light is blinking red.</p>	<p>A. The temperature sensor is not connected.</p>	<p>A. Connect the temperature sensor.</p>
	<p>B. The temperature sensor is damaged.</p>	<p>B. Call the Customer Care Center using the information provided on the back page of this manual.</p>
<p>8. "DATA LINK" light is blinking red.</p>	<p>A. A connection to the controller has not yet been established.</p>	<p>A. Wait for the connection to be made.</p>
	<p>B. A connection to the controller cannot be established.</p>	<p>B. Remove and reattach the cable that connects the adapter to the controller. Inspect the cable for damage and replace if necessary.</p>
	<p>C. An error has occurred.</p>	<p>C1. Check the error code on the user interface. See the corresponding error code in this document.</p>

Troubleshooting (cont.)		
Symptoms	Probable Causes	Recommended Action
		C2. Reset power to the steam generator and controller.
		C3. Perform a system reset on the user interface.
9. Steam menu disappears after requesting steam.	A. Cables between the steam generator(s) and adapter are installed incorrectly.	A1. Reinstall the black and/or white cable(s) between the steam generator(s) and adapter according to the instructions in the installation guide.
		A2. Call the Customer Care Center using the information provided on the back page of this manual.
10. Display does not show steam function.	A. Inadequate power is supplied to the steam generator (green status light on steam generator is off).	A1. Provide proper power to the steam generator. Use the provided test kit, if necessary, to ensure that the steam generator is working properly.
		A2. Call the Customer Care Center using the information provided on the back page of this manual.
	B. The adapter is damaged (green status light on steam generator is on).	B1. Use the provided test kit and instructions to identify the source of the problem.
		B2. Call the Customer Care Center using the information provided on the back page of this manual.

Troubleshooting (cont.)		
Symptoms	Probable Causes	Recommended Action
11. Water from steam head.	A. Normal operation.	A1. A small amount of water discharged from the steam head just before, during, and just after steam use is normal.
		A2. Water discharge from the steam head during the Power Clean cycle is normal.
	B. Water supply lines are connected incorrectly.	B. Review the steam generator installation guide and reinstall the lines at the proper locations.
	C. Internal steam generator components are not functioning properly.	C1. Turn off water supply to the steam generator. If possible, drain the tank. Slowly open the water supply valve to refill the steam generator.
C2. Call the Customer Care Center using the information provided on the back page of this manual.		
12. No steam after 5 minutes of activating the steam.	A. An error has occurred.	A. Check the user interface for error messages. If an error message appears, see the appropriate error message troubleshooting.
	B. The temperature setpoint has already been reached.	B. Confirm that the temperature setpoint is greater than the current steam room temperature. Increase the temperature setpoint if desired.

Troubleshooting (cont.)		
Symptoms	Probable Causes	Recommended Action
	C. Inadequate power is supplied to the steam generator (green status light on steam generator is off).	C1. Provide proper power to the steam generator. If necessary, use the provided test kit to ensure that the steam generator is working properly.
		C2. Call the Customer Care Center using the information provided on the back page of this manual.
	D. Cables between the steam generator(s) and adapter are installed incorrectly.	D. Reinstall the black and/or white cable(s) between the steam generator(s) and adapter according to the instructions in the installation guide.
	E. Steam line or steam head is blocked.	E. Check the steam head and steam line for blockages. Repair as necessary.
	F. Steam generator is damaged.	F1. Use the provided test kit to check steam generator function.
		F2. Call the Customer Care Center using the information provided on the back page of this manual.
13. Steam stopped.	A. An error has occurred.	A. Check the user interface for error messages. If an error message appears, see the appropriate error message troubleshooting.
	B. The session time limit was met or the temperature setpoint was met.	B. Restart the session timer or increase the temperature setpoint to restart steam.

Warranty

KOHLER Steam Generator THREE-YEAR LIMITED WARRANTY

Kohler steam generator units manufactured after September 15, 2001, are warranted to the original consumer purchaser to be free of manufacturing defects in material and workmanship during normal residential usage for three (3) years from the date of installation. This warranty only applies to KOHLER steam generator units installed in the United States of America, Canada or Mexico ("North America").

If a defect is found in normal residential usage, Kohler Co. will, at its election, repair or replace the unit, or make appropriate adjustment. Damage caused by accident, misuse or abuse is not covered by this warranty. Proof of purchase (original sales receipt) must be provided to Kohler Co. with all warranty claims. Kohler Co. is not responsible for labor charges, removal charges, installation, or other consequential costs. In no event shall the liability of Kohler Co. exceed the purchase price of the unit.

If this unit is used commercially or installed outside of North America, Kohler Co. warrants the unit to be free from defects in material and workmanship for one (1) year from the date of installation with all other terms of this warranty applying except duration.

To obtain warranty service contact Kohler Co., either through your Dealer, Plumbing Contractor, Home Center or E-tailer or by writing Kohler Co., Attn: Customer Care Center, 444 Highland Drive, Kohler, WI 53044, USA, or by calling 1-800-4-KOHLER (1-800-456-4537) from within the USA and Canada, and 001-800-456-4537 from within Mexico, or visit www.kohler.com within the USA, www.ca.kohler.com from within Canada, or www.mx.kohler.com in Mexico.

KOHLER CO. AND/OR SELLER ARE PROVIDING THESE WARRANTIES IN LIEU OF ALL OTHER WARRANTIES, EXPRESSED OR IMPLIED, INCLUDING BUT NOT LIMITED TO THE IMPLIED WARRANTIES OF MERCHANTABILITY AND FITNESS FOR A PARTICULAR PURPOSE. KOHLER CO. AND/OR SELLER DISCLAIM ANY LIABILITY FOR SPECIAL, INCIDENTAL OR CONSEQUENTIAL DAMAGES. Some states/provinces do not allow limitations on how long an implied warranty lasts, or the exclusion or limitation of special, incidental or consequential damages, so these limitations and exclusions may not apply to you. This warranty gives you specific legal rights. You may also have other rights, which vary from state/providence to state/providence.

This is Kohler Co.'s exclusive written warranty.