

I-Series Plus Condensing Boiler

User Manual

Rinnai



WARNING

If the information in these instructions are not followed exactly, a fire or explosion may result causing property damage, personal injury, or loss of life.

- Do not store or use gasoline or other flammable vapors and liquids in the vicinity of this or any other appliance.
- **WHAT TO DO IF YOU SMELL GAS**
 - Do not try to light any appliance.
 - Do not touch any electrical switch; do not use any phone in your building.
 - Immediately call your gas supplier from a neighbor’s phone. Follow the gas supplier’s instructions.
 - If you cannot reach your gas supplier, call the fire department.
- Installation and service must be performed by a qualified installer, service agency or the gas supplier.

Contents

1. Welcome	3
1.1 Acronyms and Abbreviations.....	3
2. Safety	3
2.1 Safety Symbols.....	3
2.2 Safety Precautions	4
2.3 Gas Operating Instructions	6
3. About the Boiler	7
3.1 Front View	7
3.2 Bottom View	8
3.3 Control Panel	10
4. Operating the Boiler	13
4.1 Turn the Boiler On or Off.....	13
4.2 Change Units of Measurement	14
4.3 Change Control Panel Sound.....	14
4.4 Change Child Lock Function.....	15
4.5 Adjust DHW Temperature	16
4.6 Indirect Tank DHW Operation Settings	18
4.7 DHW Comfort Modes (Combi Only).....	19
4.8 Adjust Central Heating Temperature	20
4.9 Boost Mode	21
4.10 CH Button Operation Mode	22
4.11 Setting CH Comfort Modes.....	22
5. Troubleshooting	23
5.1 Troubleshooting.....	23
5.2 Diagnostic Codes	25
6. Maintenance	27
6.1 Owner Maintenance.....	27
6.2 Freeze Protection	28
Appendix A: Federal Communication Commission (FCC) Interference Statement	29
Appendix B: Industry Canada Statement	29

Models

This manual is applicable for the I-Series Plus Combi and Heat-Only (Solo) boiler models.

Combi Models	
IP060160C	(REB-B1847FF-US)
IP090099C	(REB-B2630FF-US)
IP090160C	(REB-B2647FF-US)
IP090199C	(REB-B2658FF-US)
IP120199C	(REB-B3558FF-US)
IP150199C	(REB-B4458FF-US)
IP175199C	(REB-B5258FF-US)
IP199199C	(REB-B5858FF-US)

Heat-Only (Solo) Models	
IP060S	(REB-B1800FF-US)
IP090S	(REB-B2600FF-US)
IP120S	(REB-B3500FF-US)
IP150S	(REB-B4400FF-US)
IP175S	(REB-B5200FF-US)
IP199S	(REB-B5800FF-US)

1. Welcome

Thank you for purchasing a Rinnai I-Series Plus Condensing Boiler. Before using this boiler, please read the manual completely and retain it for future reference.

As when using any appliance generating heat, there are certain safety precautions you should follow. See section “2.2 Safety Precautions” for detailed safety precautions.

For the “Rinnai I-Series Plus Condensing Boiler Installation and Operation Manual,” please visit rinnai.us or rinnai.ca.

1.1 Acronyms and Abbreviations

Following is a list of common acronyms and abbreviations used in this manual:

Table 1

ANSI	American National Standards Institute
Btu	British Thermal Unit
CH	Central Heating
DHW	Domestic Hot Water
GPM	Gallons per minute
LP	Liquid Propane
LWCO	Low Water Cut Off
NG	Natural Gas
PP	Polypropylene
PRV	Pressure Relief Valve
PSI	Pounds per square inch
W.C.	Inches water column

2. Safety

WARNING

- If the information in these instructions is not followed exactly, a fire or explosion may result causing property damage, personal injury, or death.
- Do not store or use gasoline or other flammable vapors and liquids in the vicinity of this or any other appliance.
- **WHAT TO DO IF YOU SMELL GAS:**
 - Do not try to light any appliance.
 - Do not touch any electrical switch; do not use any phone in your building.
 - Immediately call your gas supplier from a neighbor’s phone. Follow the gas supplier’s instructions.
 - If you cannot reach your gas supplier, call the fire department.
- Installation and service must be performed by a qualified installer, service agency or the gas supplier.
- The warning signs in this manual are here to prevent injury to you and others. Please follow them explicitly.

2.1 Safety Symbols

This manual contains the following important safety symbols. Always read and obey all safety messages.



Safety alert symbol. Alerts you to potential hazards that can kill or hurt you and others.



DANGER

Indicates an imminently hazardous situation which, if not avoided, will result in personal injury or death.



WARNING

Indicates a potentially hazardous situation which, if not avoided, could result in personal injury or death.



CAUTION

Indicates a potentially hazardous situation which, if not avoided, could result in minor or moderate injury. It may also be used to alert against unsafe practices.

2.2 Safety Precautions

Please read and follow the safety precautions listed below.

DANGER

Should overheating occur or the gas supply fail to shut off, do not turn off or disconnect the electrical supply to the pump. Instead, shut off the gas supply at a location external to the appliance.

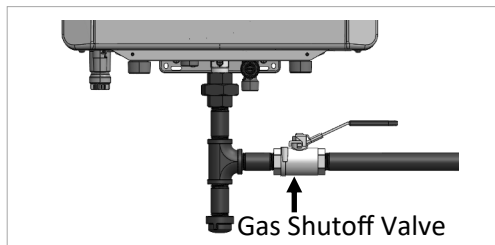

Figure 1

Heat-Only (Solo) model shown in illustration.

WARNING

Inspecting the Exhaust and Intake Venting System:

- Visually inspect the entire exhaust vent and intake system. Look closely for blockages, deterioration, leaks or any other type of damage to the system. Repair any joints that show signs of leakage. Make sure the intake vent pipe is connected and properly sealed (if applicable).
- Examine the exhaust vent and air intake to make sure they are clean and free of obstructions.

WARNING

Environment: Air surrounding the boiler, venting, and vent termination(s) is used for combustion and must be free of any compounds that cause corrosion of internal components. These include corrosive compounds that are found in aerosol sprays, detergents, bleaches, cleaning solvents, oil based paints/varnishes, and refrigerants. The air in beauty shops, dry cleaning stores, photo processing labs, and storage areas for pool supplies often contains these compounds. In applications utilizing room air where there are high levels of particulates, Rinnai offers a room air screen. The boiler, venting, and vent termination(s) should not be installed in any areas where the air may contain these corrosive compounds.

WARNING

- Before operating, smell all around the appliance area for gas. Be sure to smell next to the floor because some gas is heavier than air and will settle on the floor.
- Keep the area around the appliance clear and free from combustible materials, gasoline, and other flammable vapors and liquids.
- Do not store or use gasoline or other flammable vapors and liquids in the vicinity of this or any other appliance.
- Combustible construction refers to adjacent walls and ceiling and should not be confused with combustible or flammable products and materials. Combustible and/or flammable products and materials should never be stored in the vicinity of this or any gas appliance.
- Always check the water temperature before entering a shower or bath.
- Do not use this appliance if any part has been under water. Immediately call a licensed professional to inspect the appliance and replace any part of the control system and any manual gas control valve which has been under water.
- Do not use substitute materials. Use only parts certified for the appliance.
- It is strongly recommended that you use a trained and qualified professional who has attended a Rinnai installation training class to adjust parameter settings.
- Do not use an extension cord or adapter plug with this appliance.
- Any alteration to the appliance or its controls can be dangerous and will void the warranty.

WARNING

- Flammable liquids such as cleaning solvents, aerosols, paint thinners, adhesives, gasoline and propane must be handled and stored with extreme care. These flammable liquids emit flammable vapors and when exposed to an ignition source can result in a fire hazard or explosion. Flammable liquids should not be used or stored in the vicinity of this or any other gas appliance.
- **BURN HAZARD.** Hot exhaust and vent may cause serious burns. Keep away from the boiler. Keep small children and animals away from the boiler.
- Heating supply, return and domestic hot water outlet pipes leaving the boiler can be hot to touch.
- This product burns gas to produce heat. The appliance must be properly installed, operated, and maintained to avoid exposure to appreciable levels of carbon monoxide and the installer is required to confirm that at least one carbon monoxide alarm is installed in the living space before the appliance is put into operation. It is important for the carbon monoxide alarms to be installed, maintained, and replaced following the alarm manufacturer's instruction and applicable local codes. Rinnai recommends that every home have a carbon monoxide (CO) alarm in the hallway near bedrooms in each sleeping area. Check batteries monthly and replace them annually.
- **DO NOT** operate the boiler without the front panel installed. The front panel should only be removed for service/ maintenance or replacing internal components.



2.3 Gas Operating Instructions

FOR YOUR SAFETY READ BEFORE OPERATING

WARNING: If you do not follow these instructions EXACTLY, a fire or explosion may result causing property damage, personal injury or loss of life.

- A. This appliance does not have a pilot. It is equipped with an ignition device which automatically lights the burner. Do not try to light the burner by hand.
- B. BEFORE OPERATING smell all around the appliance area for gas. Be sure to smell next to the floor because some gas is heavier than air and will settle on the floor.
WHAT TO DO IF YOU SMELL GAS:
 - DO NOT try to light any appliance.
 - DO NOT touch any electric switch; DO NOT use any phone in your building.
 - Immediately call your gas supplier from a neighbor's phone. Follow the gas supplier's instructions.
 - If you cannot reach your gas supplier, call the fire department.
- C. Use only your hand to turn the gas control valve. Never use tools. If the gas control valve will not turn by hand, don't try to repair it, call a qualified service technician. Force or attempted repair may result in a fire or explosion.
- D. Do not use this appliance if any part has been under water. Immediately call a qualified service technician to inspect the appliance and to replace any part of the control system and any gas control which has been under water.

OPERATING INSTRUCTIONS

1. STOP! Read the safety information above on this label.
2. Set the temperature controller to lowest setting.
3. Turn off all electric power to the appliance.
4. This appliance does not have a pilot. It is equipped with a direct ignition device which automatically lights the burner. DO NOT try to light the burner by hand.
5. Turn the manual gas control valve located at gas inlet of appliance clockwise  to the OFF position.
6. Wait five (5) minutes to clear out any gas. Then smell for gas, including near the floor. If you smell gas, STOP! Follow "B" in the safety information above on this label. If you don't smell gas, go to the next step.
7. Turn the manual gas control valve located at gas inlet of appliance counter clockwise  to the ON position.
8. Turn on all electric power to the appliance.
9. Set the temperature controller to desired setting.
10. If the appliance will not operate, follow the instructions "To Turn Off Gas To Appliance" and call your service technician or gas supplier.

TO TURN OFF GAS TO APPLIANCE

1. Set the temperature controller to the lowest setting.
2. Turn off all electric power to the appliance if service is to be performed.
3. Turn the manual gas control valve located at gas inlet of appliance clockwise  to the OFF position.

3. About the Boiler

3.1 Front View

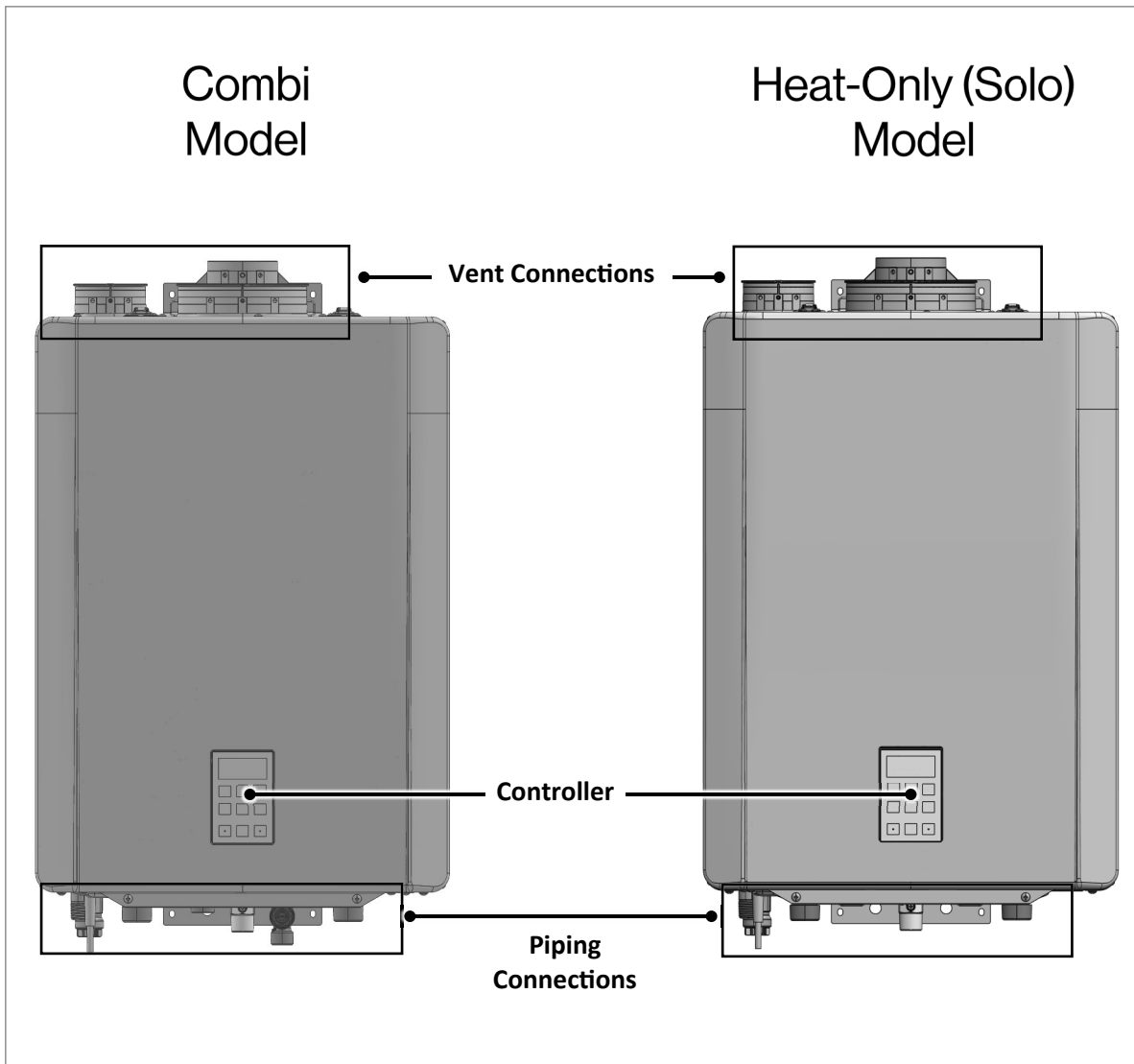

Figure 2

3.2 Bottom View

Combi Model

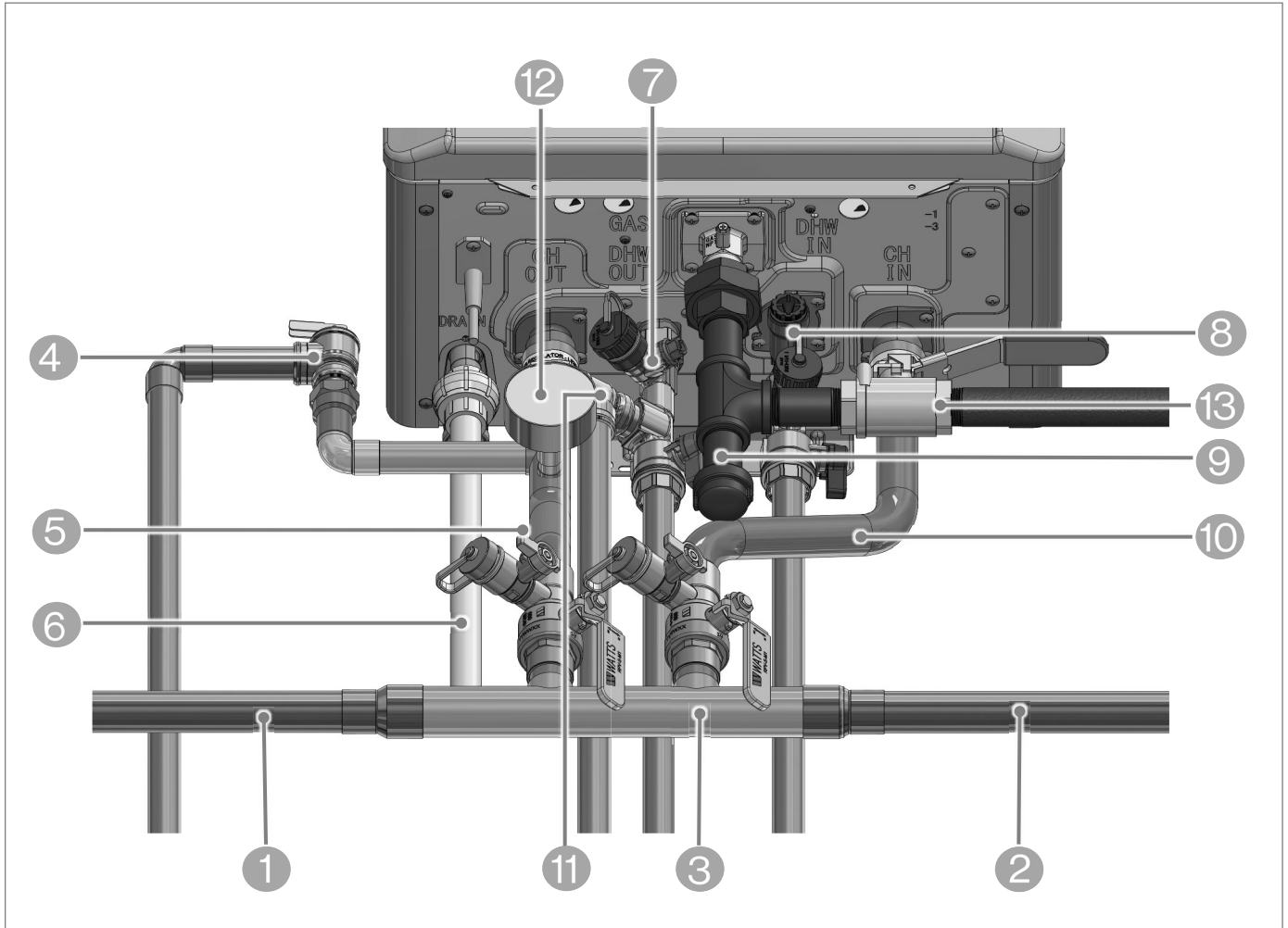

Figure 3

All items are field-supplied unless otherwise noted.

- | | |
|---|--|
| ① Supply to CH System | ⑧ Domestic Cold Water |
| ② Return from CH System | ⑨ Gas |
| ③ Primary-Secondary Heating Kit | ⑩ CH Return |
| ④ CH Pressure Relief Valve (supplied with boiler) | ⑪ Domestic Hot Water Pressure Relief Valve |
| ⑤ CH Supply | ⑫ CH Pressure Gauge |
| ⑥ Condensate Drain | ⑬ Gas Shut Off Valve |
| ⑦ Domestic Hot Water | |

Heat-Only (Solo) Model

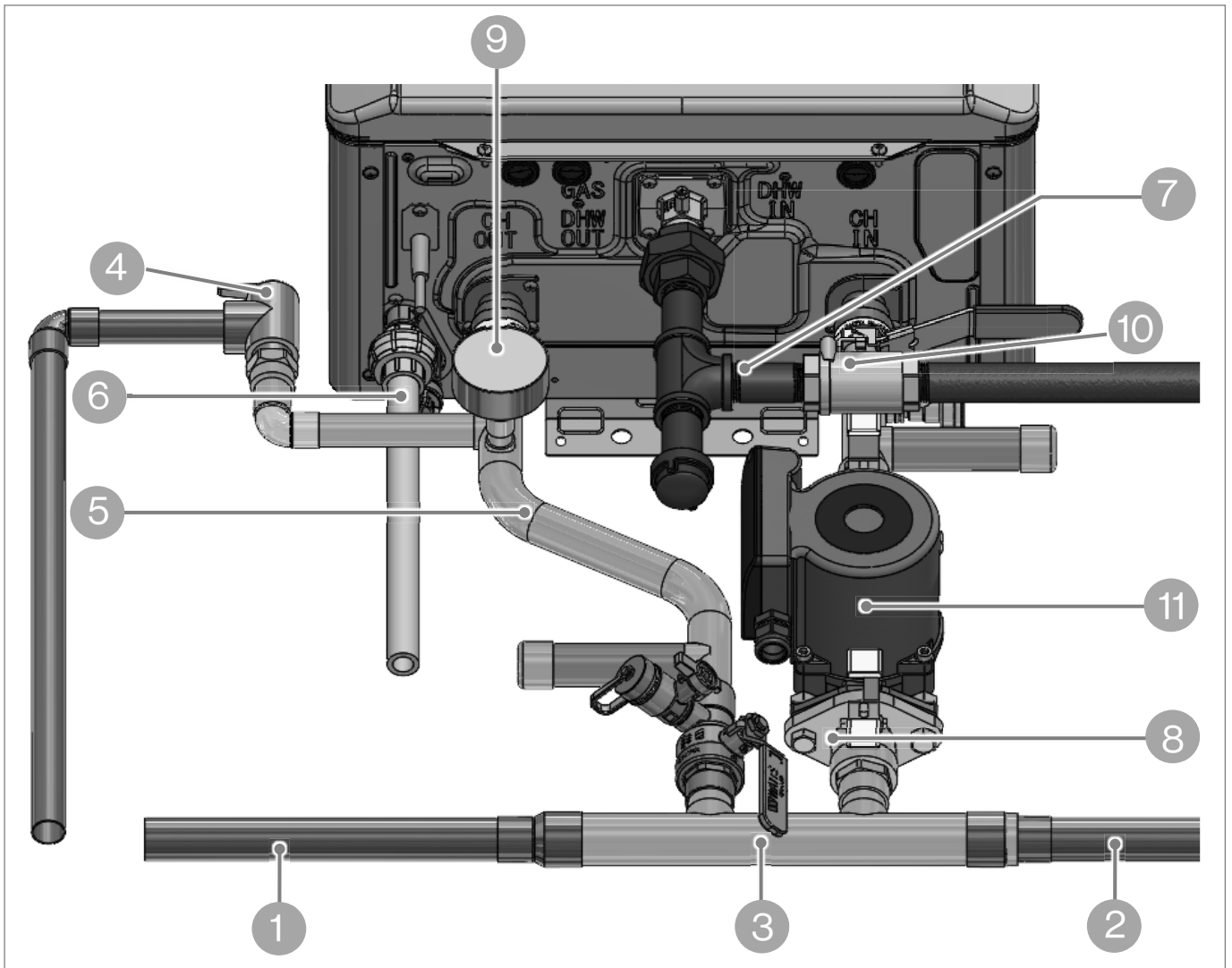

Figure 4

All items are field-supplied unless otherwise noted.

- | | |
|---|----------------------|
| ① Supply to CH System | ⑥ Condensate Drain |
| ② Return from CH System | ⑦ Gas |
| ③ Primary-Secondary Heating Kit | ⑧ CH Return |
| ④ CH Pressure Relief Valve (supplied with boiler) | ⑨ CH Pressure Gauge |
| ⑤ CH Supply | ⑩ Gas Shut Off Valve |
| | ⑪ Boiler Pump |

3.3 Control Panel

3.3.1 Control Panel Features

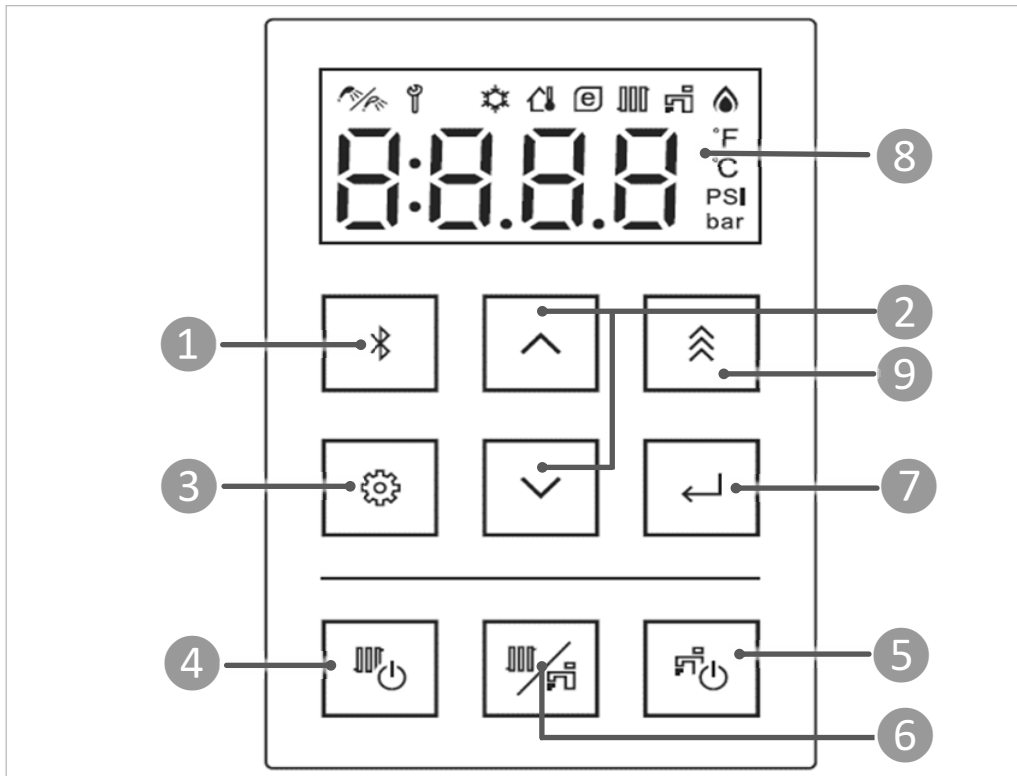

Figure 5

- | | | |
|--|--|--|
| 1 Bluetooth
Connects for BLE setup. | 4 Central Heating (CH)
Press to run the boiler in Central Heating mode. | 7 Select Button
Press to select the option in the display window. |
| 2 Up/Down Arrows
Scrolls through available menu options including adjusting the temperature. | 5 Domestic Hot Water
Press to run the boiler in Domestic Hot Water mode for Combi models, or Domestic Hot Water Indirect Tank mode for Heat-Only models. | 8 Display Window
Displays boiler status information.
See section "3.3.2 Display Window" for more information. |
| 3 Settings Menu
Selects Further Menus to adjust settings. | 6 Switch Operation Mode
Press to change the display between DHW and CH for temperature setting. | 9 Boost Button
Engages the Boost Function on the boiler. |

3.3.2 Display Window

When the boiler is turned on, the main screen (also called the home screen) appears in the display.

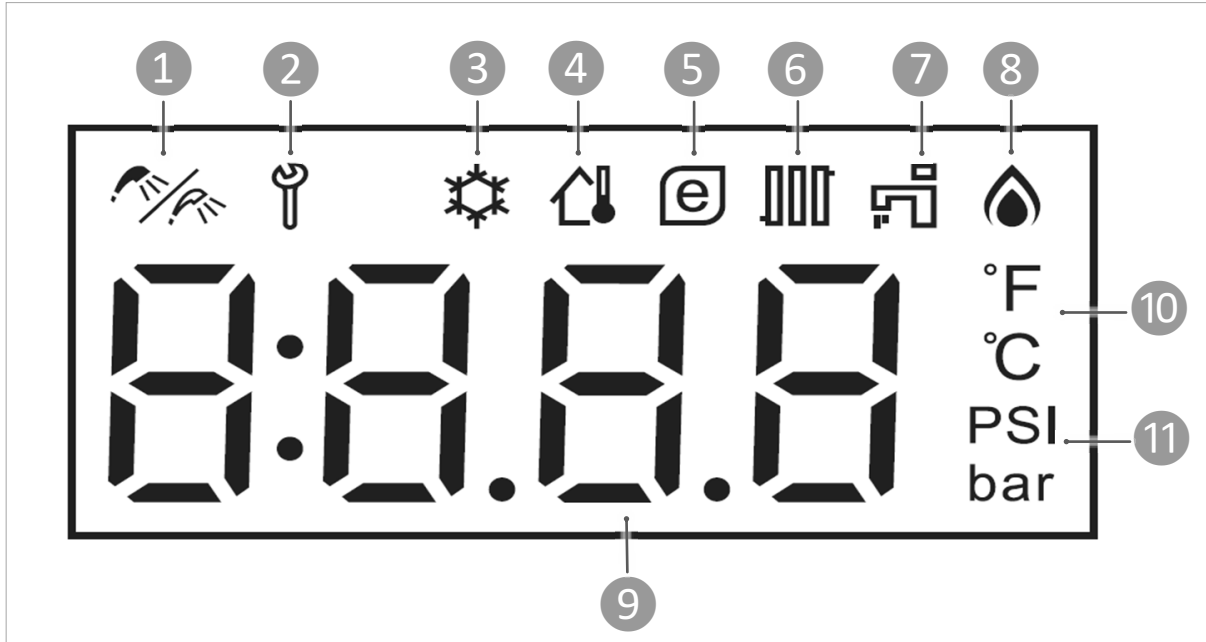

Figure 6

- | | |
|--|--|
| <p>1 Priority Icon
This icon will be present on the controller that has priority.</p> <p>2 Maintenance Mode Icon
Appears when the boiler is in Parameter Settings Mode, Deaeration Mode, Performance Data Mode, Error History Mode, etc.</p> <p>3 Freeze Protection Active</p> <p>4 Outdoor Temperature Sensor Connected</p> <p>5 Eco Mode Active</p> <p>6 Central Heating Mode Active</p> | <p>7 Domestic Hot Water Mode Active</p> <p>8 "In Use" Light (boiler has fired and is running)</p> <p>9 Setpoint Temperature, Current Temperature or Current Pressure, and Diagnostic Information
Note: Pressure and temperature are alternately displayed on the controller.</p> <p>10 Unit of Measurement for Temperature</p> <p>11 Unit of Measurement for Pressure
Note: Pressure and temperature are alternately displayed on the controller.</p> |
|--|--|

3.3.3 Pressure and Temperature Display

The boiler will display the current pressure or temperature as shown below.

Standby

If the boiler is in standby and the **CH** and **DHW** buttons are not illuminated, the current system pressure will display.

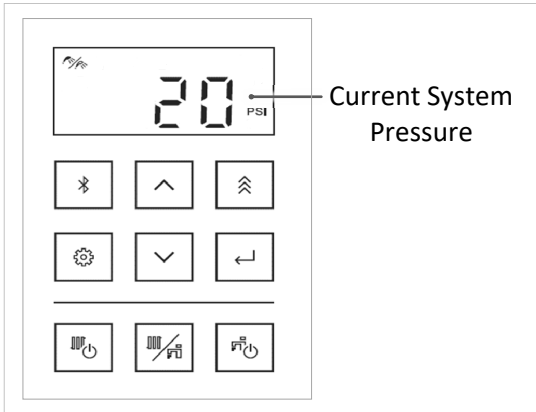

Figure 7

Domestic Hot Water Operation

When the boiler is in DHW operation and DHW standby (**DHW** icon is displayed), the current system pressure and the DHW set point temperature will alternately display.

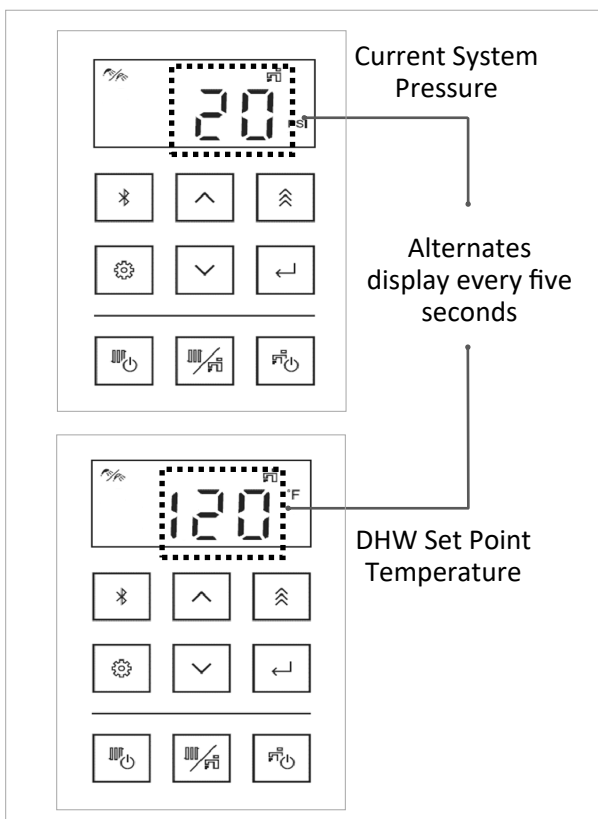

Figure 8

Central Heating Operation

When the boiler is in CH operation and CH standby (**CH** icon is displayed), the current pressure and the CH supply temperature will alternately display.

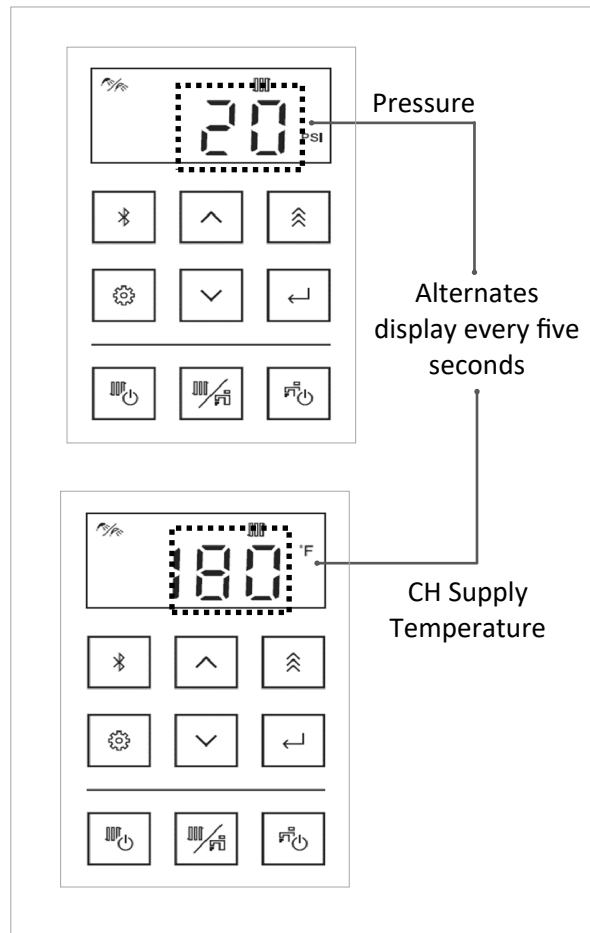

Figure 9

- If a warning diagnostic code appears, the code will cycle quicker between the current pressure, temperature, and the diagnostic code.
- If an error diagnostic code appears, only the code will display.

4. Operating the Boiler

This section includes instructions for starting and operating the boiler.

WARNING

Do not use an extension cord or adapter plug with this appliance.

4.1 Turn the Boiler On or Off

Connect power to the boiler by plugging it into a power outlet.

IMPORTANT

When power is connected for the first time, the initial settings must be set by a licensed professional. Contact a qualified installer.

In future power-ups, after plugging in the unit, it will be ready for normal operation.

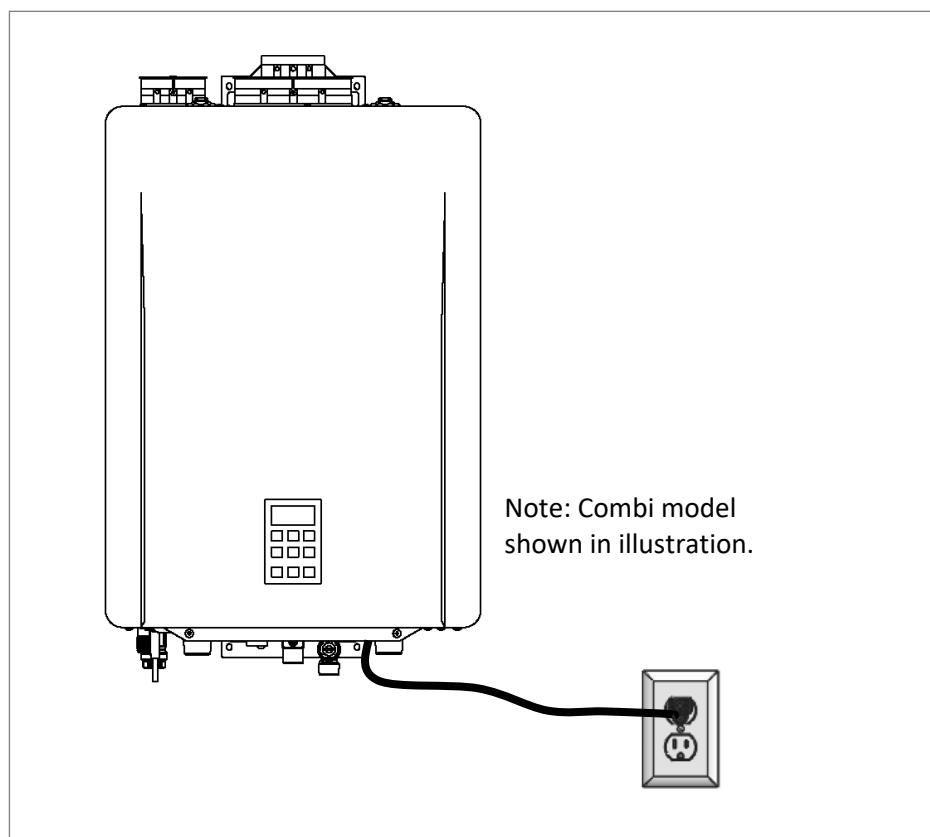

Figure 10

4.2 Change Units of Measurement

To change the units of measurement appearing on the boiler display, follow the steps below.

1.

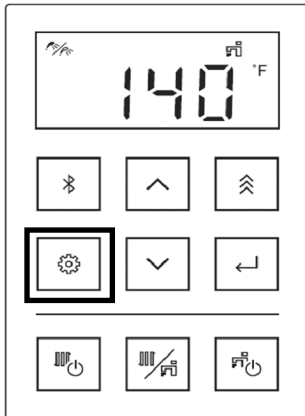

Figure 11

Press the **Settings Menu** button.

2.

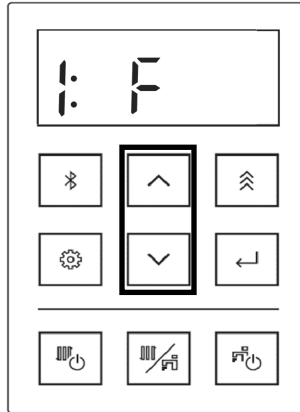

Figure 12

Press the **Up** or **Down** arrows to select a unit.

- **F** = U.S. Measurement (°F/PSI)
- **C** = Metric (°C/bar)

3.

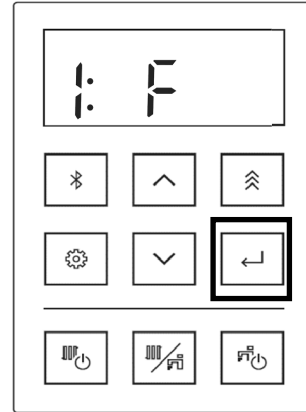

Figure 13

Press the **Select** button.

4.3 Change Control Panel Sound

To turn the control panel click sound on or off, follow the steps below.

1.

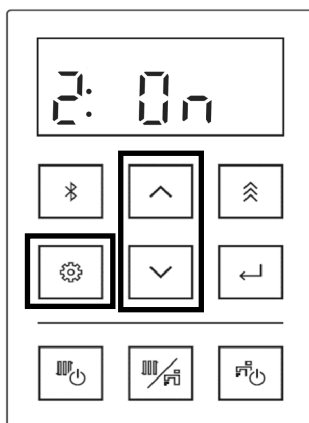

Figure 14

Press the **Settings Menu** button twice.

2:On should appear on the display.

Press the **Up** or **Down** arrows to select ON or OFF.

2.

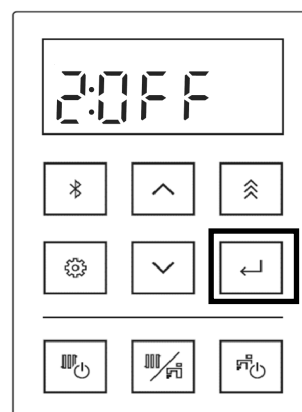

Figure 15

Press the **Select** button.

4.4 Change Child Lock Function

To turn the child lock function on or off, follow the steps below.

▶ IMPORTANT

- When Child Lock mode is enabled, the only function available is to turn off Central Heating (by pressing the **Central Heating** button on the controller).
- If using multiple controllers, Child Lock can be set only on the controller that has priority.
- If a button is pressed when the Child Lock function is engaged, "LOC" will be displayed on the controller.

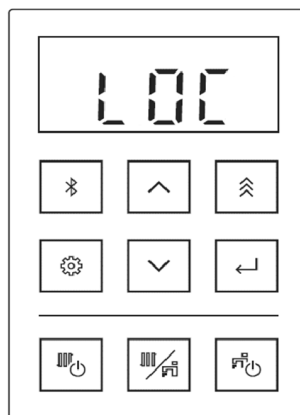

Figure 16

1.

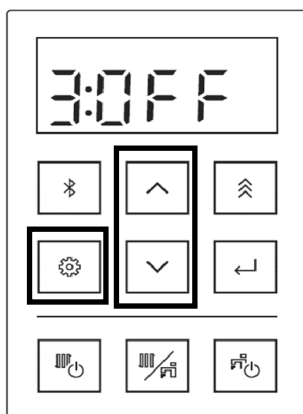

Figure 17

Press the **Settings Menu** button three times. **3:0FF** should appear on the display. Press the **Up** or **Down** arrows to select:

- OFF - Child Lock OFF
- LOC - Child Lock ON

2.

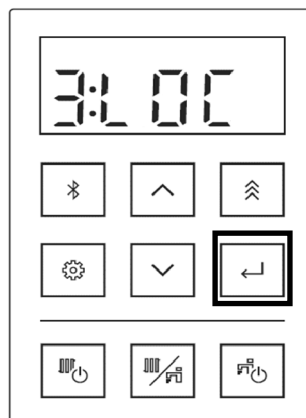

Figure 18

Press the **Select** button.

4.5 Adjust DHW Temperature

Rinnai combi or heat-only boilers utilizing an indirect tank controlled via a thermistor can have the domestic hot water temperature adjusted via the temperature controller on the front of the unit (refer to the steps below for instructions).

To adjust temperature for a heat-only boiler utilizing an indirect tank controlled via a thermostat, parameters will need to be adjusted. See the Boiler Installation and Operation Manual for further information.

To adjust the DHW setpoint temperature, follow the steps below.

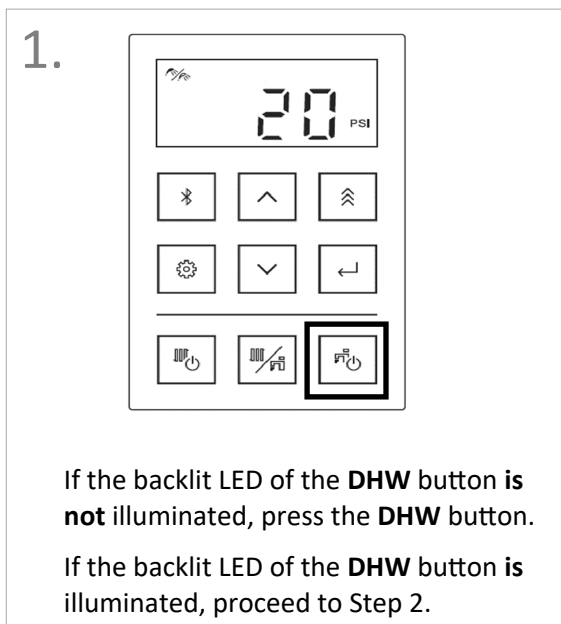

Figure 19

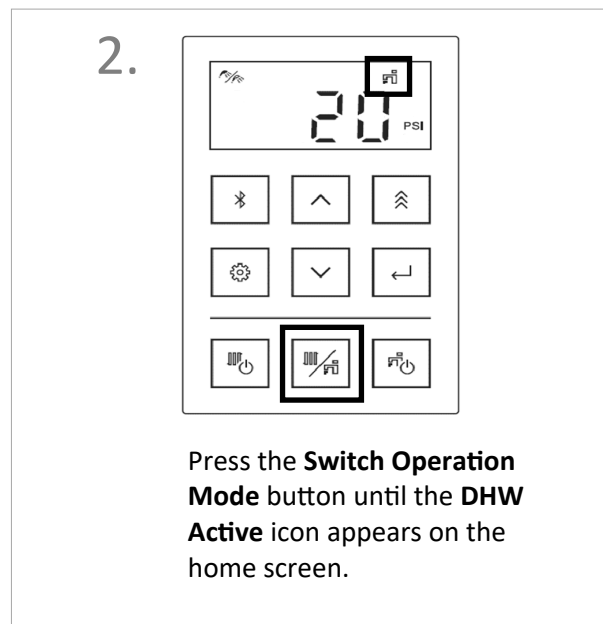

Figure 20

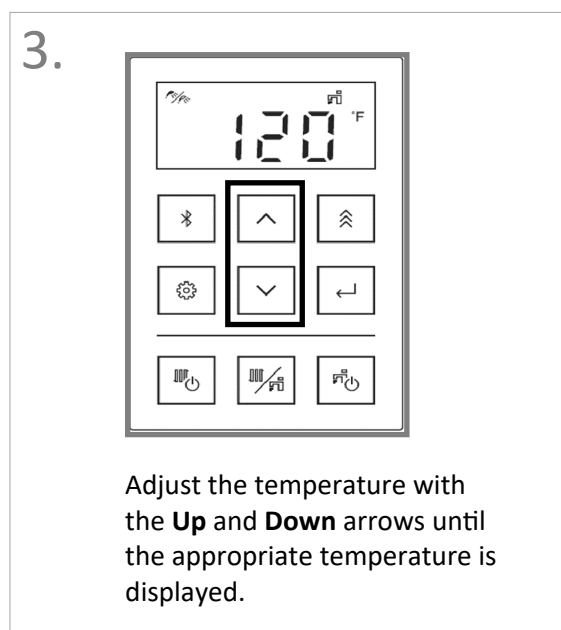

Figure 21

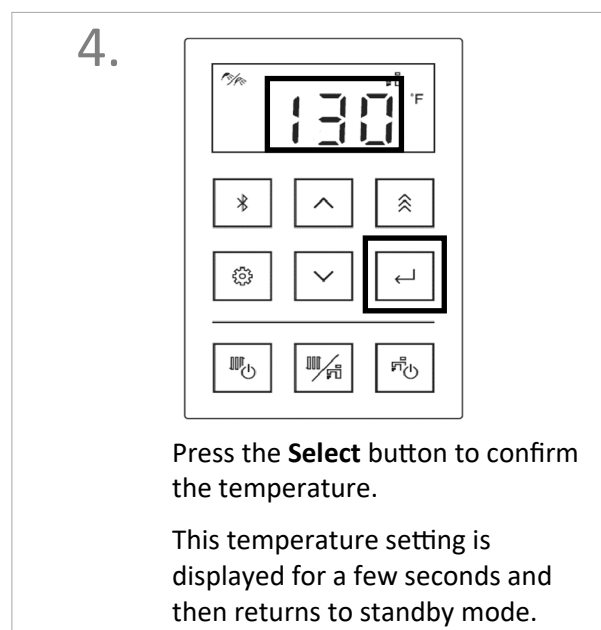

Figure 22

The available DHW set point temperatures are provided below. When the unit of measurement changes (°C/°F), the corresponding temperature in the table changes.

Factory Default: 120°F

The factory default maximum temperature is limited to 120°F. To select temperatures above 120°F (49°C), the DHW Maximum Setpoint Temperature will need to be adjusted. Please refer to the Boiler Installation and Operation Manual for further details.

Table 2

Temperature Settings	
Fahrenheit (°F)	Celsius (°C)
98	37
100	38
102	39
104	40
106	41
108	42
110	43
112	44
114	45
116	46
118	47
120	48
125	49
130	50
135	52
140	54
	56
	58
	60

This boiler requires a minimum flow rate of 0.4 GPM to operate. In some cases when you are not getting hot water or if the water alternates between hot and cold, it is due to the water flow being below or close to the minimum flow rate. Increasing the flow rate should resolve these problems.

If you are experiencing fluctuating water temperatures at a fixture, this may be due to a high temperature setting on your boiler (130°F-140°F) (54°C-60°C). Decreasing the setpoint temperature may alleviate the fluctuations and deliver a stable temperature.

! DANGER



Water temperatures over 125°F (52°C) can cause severe burns or scalding resulting in death.

Hot water can cause first degree burns with exposure for as little as:

- 3 seconds at 140°F (60°C)
- 20 seconds at 130°F (54°C)
- 8 minutes at 120°F (49°C)

Children, disabled, or elderly are at highest risk of being scalded.

Feel water before bathing or showering.

➔ IMPORTANT

- While any hot water is being provided, the temperature setting can only be adjusted between 98°F and 110°F.
- Check local codes for the maximum water temperature setting allowed when used in nursing homes, schools, day care centers, and all other public applications.
- If a newly installed boiler with a controller has not been powered for at least six hours, the temperature will return to the default setting of 120°F (49°C).
- There may be a variation between the temperature displayed on the temperature controller and the temperature at the tap due to weather conditions or the length of pipe to the boiler.

4.6 Indirect Tank DHW Operation Settings

The appliance can change the indirect tank set point temperature at the boiler controller when the indirect tank is connected to the boiler PC Board. This is only applicable when using the indirect tank thermistor.

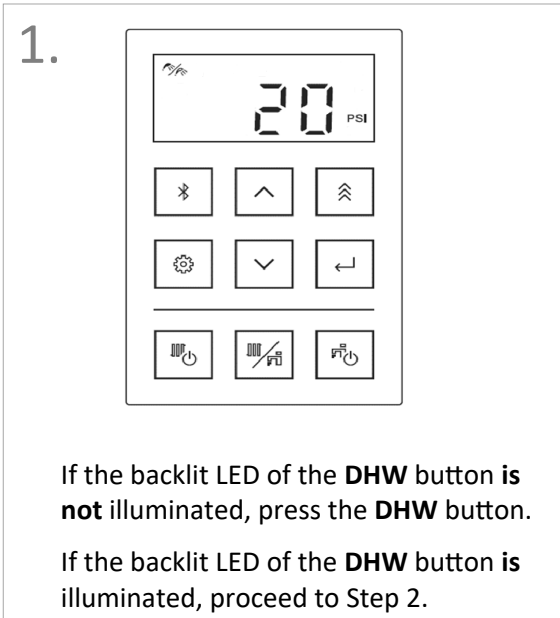

Figure 23

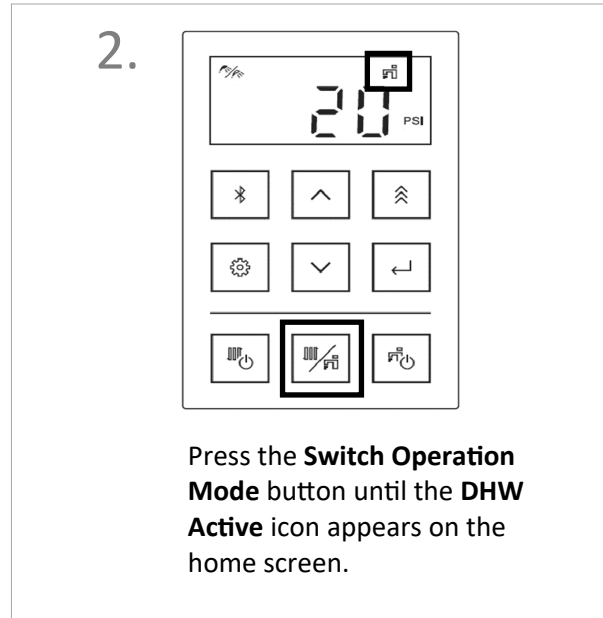

Figure 24

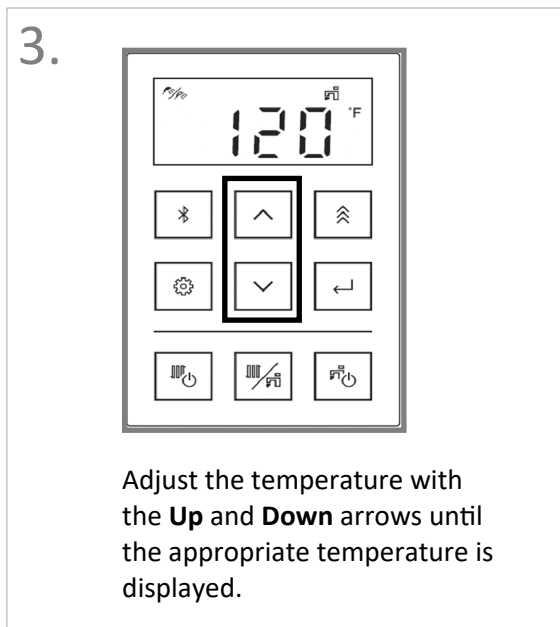

Figure 25

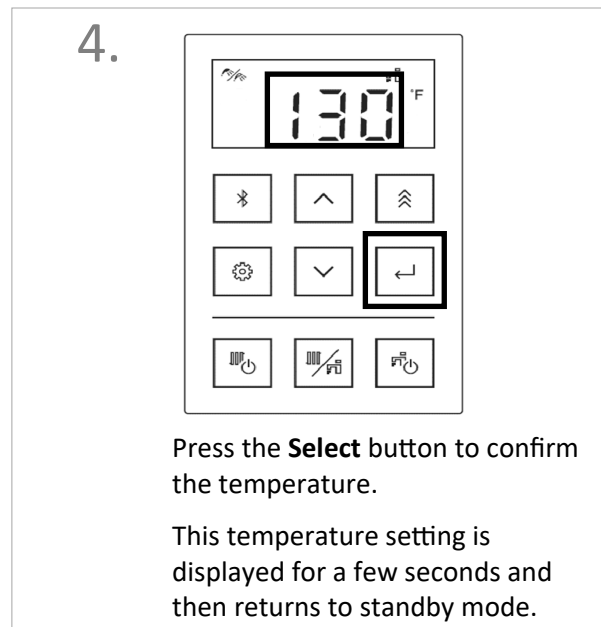

Figure 26

Indirect Tank Temperature Settings:

Temperature:	120°F (50°C)	130°F (55°C)	140°F (60°C)	150°F (65°C)
--------------	--------------	--------------	--------------	--------------

For using a thermostat, see details regarding parameter 30 in the Boiler Installation and Operation Manual.

4.7 DHW Comfort Modes (Combi Only)

Domestic Hot Water Comfort Modes are settings that would either supply quicker delivery of hot water to fixtures or save energy in the boiler operation.

- **Eco Mode (Default) (Eco icon illuminates)**

The boiler operates and produces hot water; however, it will not maintain the primary heat exchanger temperature for quicker hot water production. This selection saves some energy, but requires a longer time to provide hot water to the hot water fixtures.

- **Comfort Mode (Eco icon does not illuminate)**

The boiler maintains the primary heat exchanger temperature to quickly deliver hot water to the plate heat exchanger. This selection provides the quickest delivery of hot water to hot water fixtures, but uses more energy.

By default, Eco mode is enabled (turned on). To enable (turn on) comfort mode, refer to steps 1 and 2 below.

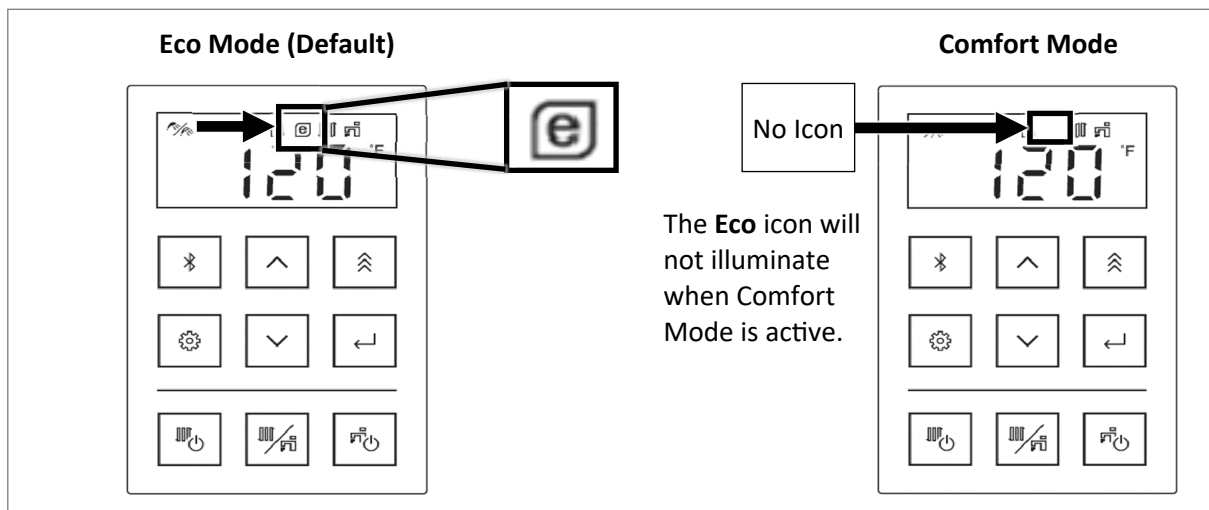

Figure 27

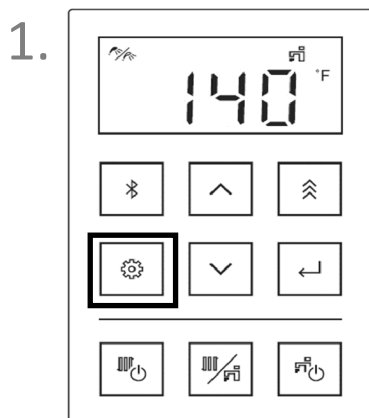

Figure 28

Press the **Settings Menu** button four times.

NOTE
During DHW recirculation, the Eco icon will always be on.

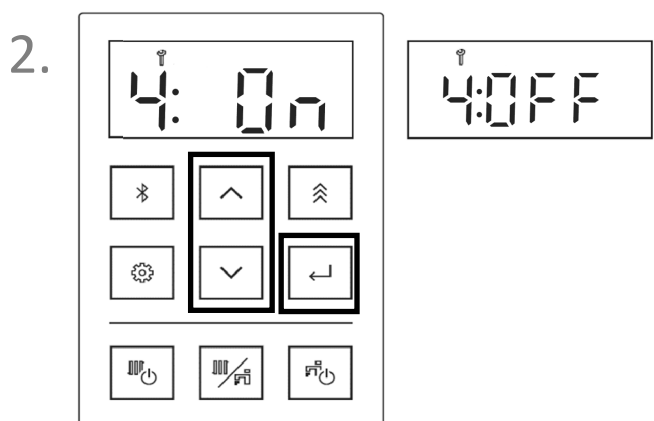

Figure 29

Press the **Up** or **Down** arrows to select the mode, and press the **Select** button.

- **On** = Eco Mode Active
- **OFF** = Comfort Mode Active

4.8 Adjust Central Heating Temperature

The Central Heating (CH) setpoint temperature is not adjustable in outdoor reset control unless the custom heating curve (Curve 7) is selected. See the Boiler Installation and Operation Manual for further information.

IMPORTANT

- When outdoor reset control activates, the target supply temperature for the CH system will not follow the target temperature set on the controller. (This is different from the temperature displayed when changing the temperature setting.)
- When the boiler is in operation, pressure and temperature are alternately displayed on the controller.

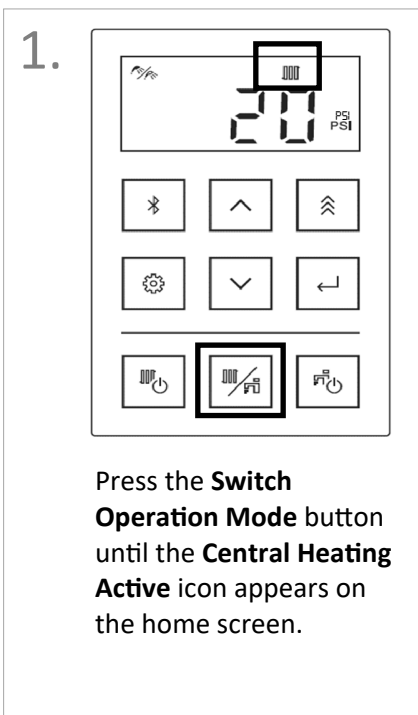

Figure 30

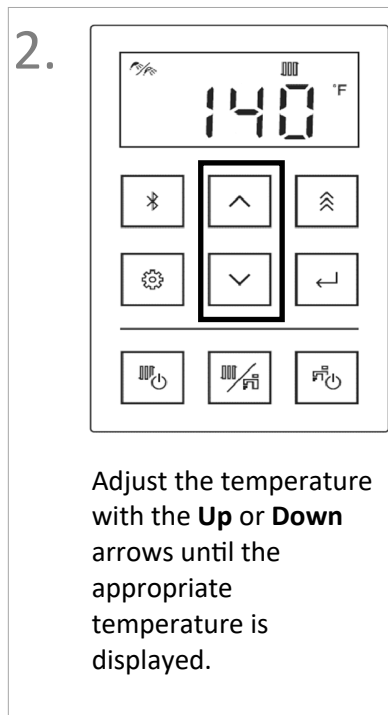

Figure 31

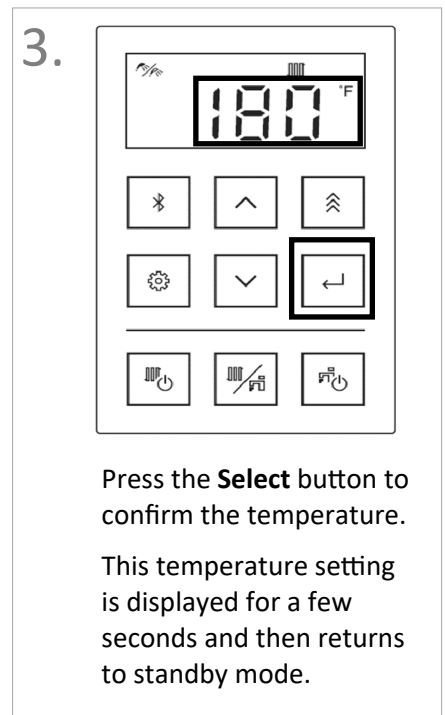

Figure 32

4.9 Boost Mode

Boost mode allows the boiler to override the target temperature determined by the outdoor reset control, and will boost the boiler target temperature to maximum permissible setting. This will occur until the call for heat is satisfied or the boiler cycles off. This will enable the area being heated to come to temperature faster than in normal operation.

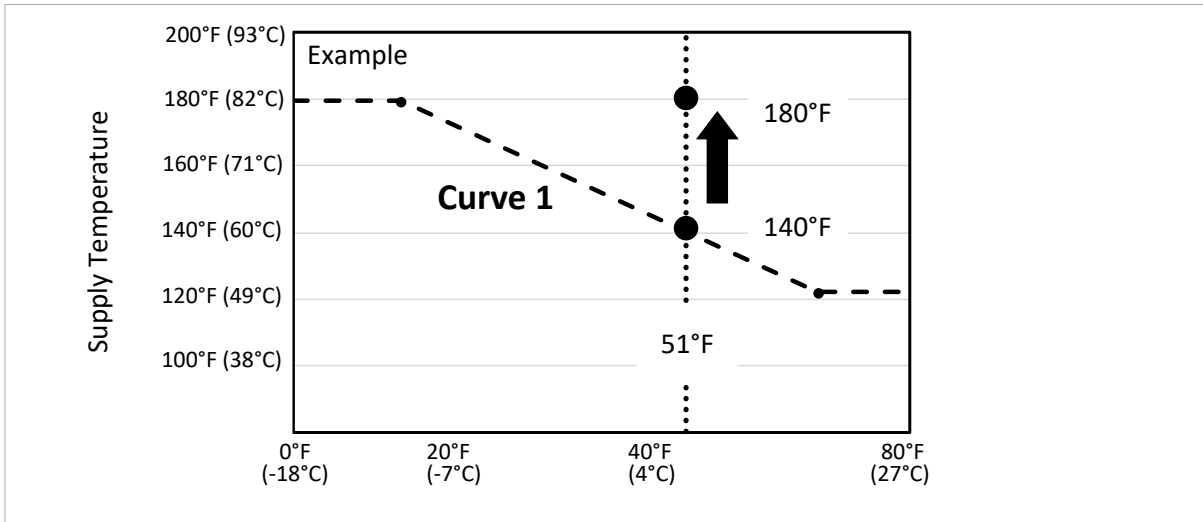

Figure 33

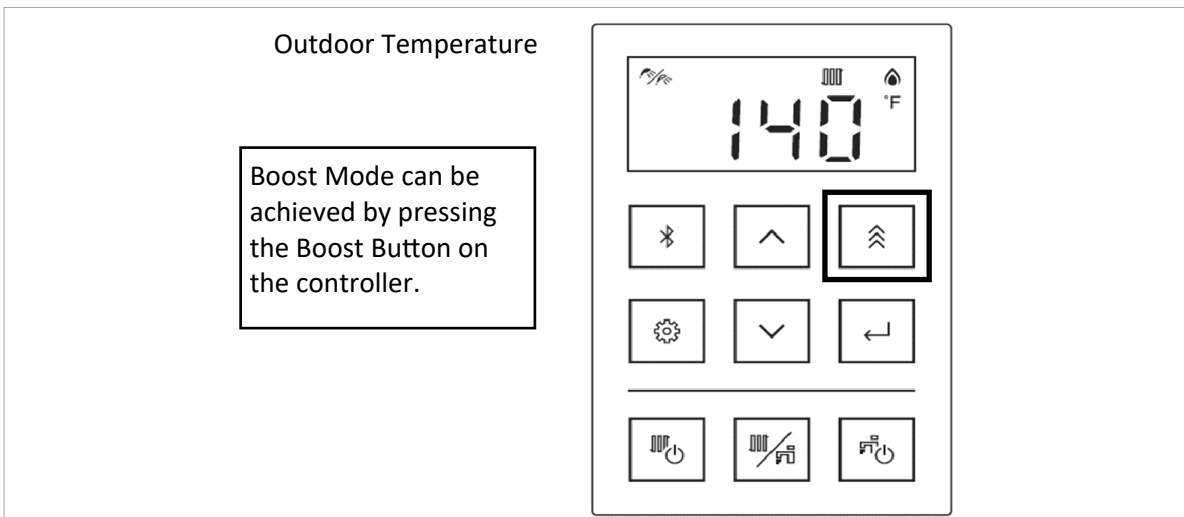

Figure 34

4.10 CH Button Operation Mode

Central Heating Button

IMPORTANT

Central Heating Button Operation Mode on the I-Series Plus Boiler is not designed for typical room thermostat control systems. Central Heating Button Operation Mode runs the pump(s) and heat constantly and ignores room thermostat input. This mode may/will overheat zones not equipped with constant recirculation temperature control (such as thermostatic heads).

This setting enables the boiler to operate via the **Central Heating** button being active (illuminated). While the **Central Heating** button is ON, the boiler operates continuously or until the return and supply sensors on the boiler gives the signal to cycle off. The burner fires up only when supply or return water temperature reduces. This setting should be disabled when CH is no longer seasonally needed. For setting information, refer to the Boiler Installation and Operation Manual.

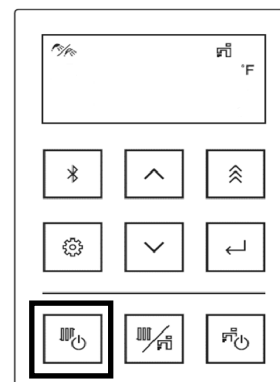

Figure 35

4.11 Setting CH Comfort Modes

Central Heating Eco mode is a gas-saving function available on the I-Series Plus Heat-Only boilers.

The steps for activating Central Heating Eco mode are the same steps for activating DWH Comfort mode. To set up Central Heating Eco mode, refer to figures 28 and 29 in section “4.7 DWH Comfort Modes (Combi Only).” For further details on operation of this setting, please refer to the Boiler Installation and Operation Manual.

Eco Mode (Default) (Eco icon illuminates)	Comfort Mode (Eco icon does not illuminate)
<p>To reduce the amount of gas used in CH operation, Eco mode will turn the space heating off for five minutes at random intervals.</p>	<p>The boiler will operate via a call for heat from the thermostat or the CH button, depending on the parameter setting. This mode will use more gas but will provide a more consistent home heating temperature.</p>
<p>Eco Mode (Default)</p>	<p>Comfort Mode</p>

Figure 36

5. Troubleshooting

WARNING

Consumers should never attempt any action that they are not qualified to perform.

5.1 Troubleshooting

If you believe the boiler is not operating as designed, check possible reasons from the list below.

If an Error Diagnostic Code appears, contact a local Service Provider.

Table 3

DHW	Hot water is not available.	Check that the gas is turned on at the boiler, gas meter, or cylinder.
		When using propane gas, is there sufficient gas available?
		Is the water supply valve off or disconnected?
		Is the faucet opened sufficiently?
		Is the DHW inlet filter clean?
		Is the boiler or other system piping frozen?
		Is the DHW switch On?
		If the water flow volume is very small, the boiler will not activate. Turn on the faucet fully to allow for a greater flow demand.
	The DHW temperature and pressure are fluctuating.	Is there sufficient water pressure?
		Is the setpoint temperature of DHW adequate?
		When the boiler is running in DHW and CH operation, the DHW temperature may fluctuate.
		When there is a long, uninsulated piping length between the boiler and fixture, the hot water temperature fluctuates. Ask the dealer to add insulation on the piping or increase the setpoint temperature.
	The boiler ceases to fire during a DHW demand.	Check that the gas is turned on at the boiler, gas meter, or cylinder.
		When using propane gas, is there sufficient gas available?
		If the water flow volume is very small, the boiler will not activate. Open a faucet more to allow for a greater flow demand.
		Reset the boiler by closing and opening the faucet again.
	The amount of hot water is fluctuating.	When DHW is used in multiple faucets at same time, the amount of hot water may be restricted.
		DHW may be restricted. The water supply pressure or system piping may affect the hot water volume.
	After the power is out or the power plug is pulled out, the setpoint temperature has changed.	The setpoint temperature may change after the boiler has had power restored. The setpoint temperature must be entered again.

Table 3 (Continued)

Central Heating	The room temperature is not getting warm.	Is the target setpoint temperature of central heating appropriate for your application? Refer to section “4.8 Adjust Central Heating Temperature” in this manual for more information.
		When an outdoor sensor control is used, the supply temperature for central heating will vary depending on the outdoor temperature. To change the setting, contact your dealer.
		When using DHW with priority setting ON, central heating may be in standby. To change the setting of the simultaneous heating and DHW operation, contact your dealer.
		Check that the gas is turned on at the boiler, gas meter, or cylinder.
		When using propane gas, is there sufficient gas available?
Controller	The CH button does not work.	Contact a service provider for assistance.
	The DHW button does not work for the Heat-Only boiler.	The indirect tank is not set up in settings. Contact a service provider for assistance.
	The setting temperature of DHW cannot be set higher than 120°F (49°C).	The maximum temperature setting may be selected at 120°F (49°C). To change the setting, contact your dealer.
	Cannot change the DHW set point temperature.	While DHW is being provided, the temperature can only be adjusted between 98°F and 110°F.
Others	The sound of a pump occurs when neither CH or DHW are in use.	When the outdoor temperature is low, the freeze prevention operation may start with pump operation.
		When the boiler is not activated, the pump may operate for preventing locking up. The pump is operating to enable quicker output of DHW from the boiler.
	The boiler does not begin operation after power has been restored.	When power has been restored after a power outage or the power plug is disengaged, the boiler will not start operating while initializing. Wait for 5 minutes and start using the boiler as normal.
	Cannot turn off Eco Mode switch.	During DHW recirculation, Eco will always be on.
	White water vapor at exhaust vent top	When the exhaust temperature is higher than the ambient air, you will see white vapor at the exhaust vent top.

5.2 Diagnostic Codes

When the boiler detects an error or unexpected performance, a diagnostic code will display on the controller and a beeping sound will generate. Contact a qualified service provider whenever a diagnostic code shuts down the boiler.

Table 4

Diagnostic Code	Diagnostic Code Cause
021	Too Long DHW (Combi Only)
100	Air Supply or Exhaust Blockage/Condensate Trap is Full
110	No Ignition (Unit Not Turning On)
120	Flame Failure
140	Heat Exchanger Overheat
150	Venturi Control
161	High Outgoing Temperature
170	Venturi Blockage
180	Gas Valve Adjustment Limit
190	Electrical Grounding
210	Data Transfer Error
220	Gas Valve Adjustment
250	Condensate Pump (Accessory)
303	Secondary Thermistor
310	Freeze Protection Thermistor
321	Outgoing Thermistor (Combi Only)
331	Heat Exchanger Thermistor (Combi Only)
341	Inlet Thermistor (Combi Only)
353	Supply Thermistor
363	Return Thermistor
371	Indirect Thermistor (Solo Only)
380	Exhaust Thermistor
393	Outdoor Thermistor
400	Pressure Sensor
430	High/Low Water Pressure
443	Low Water Cut-Off (LWCO)
520	Solenoid Valve Circuit
540	High Exhaust Temperature
610	Combustion Fan
631	DHW Recirculation Pump (Combi Only)
651	Water Flow Control (Combi Only)
661	By-Pass (Combi Only)

Table 4 (Continued)

Diagnostic Code	Diagnostic Code Cause
670	3-Way Valves (Combi Only)
681	Hot Water Supply Temperature Abnormality (Combi Only)
700	PC Board
710	Solenoid Valve Circuit
720	Flame Rod
763	0-10V Input
831	Indirect Tank Temperature (Solo Only)
890	Freeze Issue
LC	Scale Buildup in Heat Exchanger (Combi Only)
FFF	Maintenance Indicator
SS	Service Indicator Set by Service Professional
SE	Secondary Unit Error for Cascade System

Reset Diagnostic Codes

To reset diagnostic codes, either the **Central Heating** or **Domestic Hot Water** button on the control panel will be blinking. Press the button to reset the code.

IMPORTANT

- Diagnostic codes that occur during DHW operation may be able to reset by turning off the faucet.
- Some diagnostic codes may not reset by pressing the CH or DHW buttons. If this is the case, contact your service provider for troubleshooting assistance.

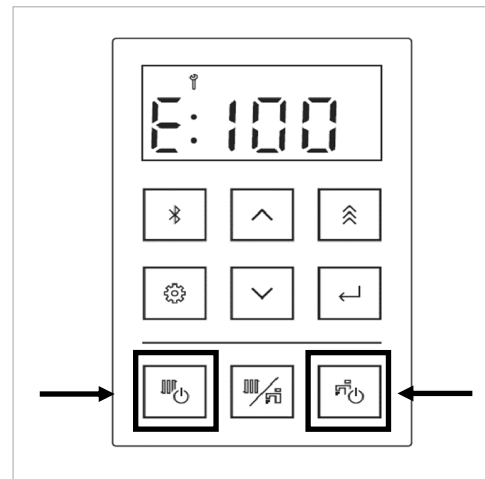

Figure 37

6. Maintenance

WARNING

- Maintenance is required to maintain safe operation of the boiler.
- The boiler must be inspected annually by a licensed professional. Repairs and maintenance shall be performed by a licensed professional. The licensed professional must verify proper operation after servicing.
- Keep the boiler area clear and free from combustible materials, gasoline, and other flammable vapors and liquids.
- To protect yourself from harm, before performing maintenance:
 - Turn off the electrical power supply by unplugging the power cord or by turning off the electricity at the circuit breaker. (The boiler controller does not control the electrical power.)
 - Turn off the gas at the gas control, usually located immediately below the boiler.
 - Turn off the incoming water supply. This can be done at the isolation valve immediately below the boiler for the domestic hot water. Turning off the water for the central heating system is done at the boiler system filling station shut-off valve or the main water supply to the building.
 - Use only your hand to turn the manual gas control valve. Never use tools. If the manual gas control valve will not turn by hand, do not try to repair it; call a trained and qualified professional. Force or attempted repair may result in a fire or explosion.

6.1 Owner Maintenance

WARNING

If you encounter a problem that is difficult to solve, stop the operation and immediately contact a licensed professional.

MONTHLY

Boiler Area

- Verify the area is free of combustible materials, gasoline and other flammable vapors and liquids.
- Verify the area is clean from dust and obstructions.
- Verify the air intake area is free of any contaminants listed in the boiler Installation and Operation Manual. Any contaminants in the boiler intake air vicinity must be removed. If they cannot be removed, contact a licensed professional.

Piping

- Inspect all water, gas, and condensation piping for leaks. Look for signs of leaking lines or corrosion.
- Confirm the condensation line is not blocked. If a condensation drain pump is used, confirm the condensation drain pump operates correctly.

Venting

- Verify the boiler vent discharge and air intake is clean and free of obstructions.
- Check for leakage, damage, or deformation of venting.

Boiler

- Verify the boiler is free from any abnormal situations, such as diagnostic error codes, loud noises, leakage or other potential issues.
- Check that the pressure on the controller display or external pressure gauge indicates 17 to 26 PSI (117 to 180 kPa).

6.2 Freeze Protection

Freeze Protection Operation

When the boiler detects low outdoor ambient temperatures, the boiler will begin its freeze protection operation. The freeze protection operation can protect the boiler from freezing down to as low as -22°F (-30°C) outdoor temperature.

When freeze protection is in operation, the pump may circulate water and/or the boiler may operate to prevent the boiler from freezing.

Ensure power and gas are supplied to the boiler for freeze protection to function. The internal freeze protection will not necessarily prevent the system piping from freezing.

During freeze protection operation, the pressure and supply temperature are alternately displayed on the controller. The display alternates between the two. The freeze protection icon is also displayed (Figure 38).

The icon for CH and DHW may alternate depending on the operation of the freeze protection sequence.

When the system needs to be shutdown for extended periods of time, the boiler and all system piping should be drained. The power and gas supply should then be disconnected from the boiler. Freezing damage may occur if there is water remaining in the boiler or system piping. The plumbing lines should also be blown out via compressed air.

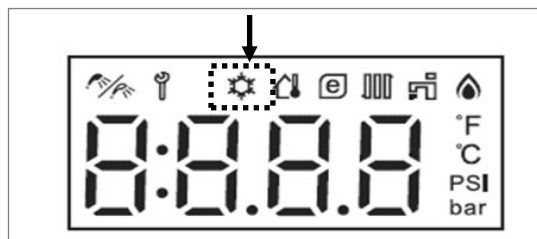

Figure 38

Appendix A: Federal Communication Commission (FCC) Interference Statement

FCC Interference Statement:

This device complies with Part 15 of the FCC Rules. Operation is subject to the following two conditions: (1) This device may not cause harmful interference, and (2) this device must accept any interference received, including interference that may cause undesired operation.

This equipment has been tested and found to comply with the limits for a Class B digital device, pursuant to Part 15 of the FCC Rules. These limits are designed to provide reasonable protection against harmful interference in a residential installation. This equipment generates, uses and can radiate radio frequency energy and, if not installed and used in accordance with the instructions, may cause harmful interference to radio communications. However, there is no guarantee that interference will not occur in a particular installation. If this equipment does cause harmful interference to radio or television reception, which can be determined by turning the equipment off and on, the user is encouraged to try to correct the interference by one of the following measures:

- Reorient or relocate the receiving antenna.
- Increase the separation between the equipment and receiver.
- Connect the equipment into an outlet on a circuit different from that to which the receiver is connected.
- Consult the dealer or an experienced radio/TV technician for help.

FCC Caution: Any changes or modifications not expressly approved by the party responsible for compliance could void the user's authority to operate this equipment.

This transmitter must not be co-located or operating in conjunction with any other antenna or transmitter.

Radiation Exposure Statement:

The product comply with the FCC portable RF exposure limit set forth for an uncontrolled environment and are safe for intended operation as described in this manual. The further RF exposure reduction can be achieved if the product can be kept as far as possible from the user body or set the device to lower output power if such function is available.

Appendix B: Industry Canada Statement

IC

This device complies with ISED's licence-exempt RSSs. Operation is subject to the following two conditions: (1) This device may not cause harmful interference, and (2) this device must accept any interference received, including interference that may cause undesired operation.

Le présent appareil est conforme aux CNR d'ISED applicables aux appareils radio exempts de licence. L'exploitation est autorisée aux deux conditions suivantes : (1) le dispositif ne doit pas produire de brouillage préjudiciable, et (2) ce dispositif doit accepter tout brouillage reçu, y compris un brouillage susceptible de provoquer un fonctionnement indésirable.

Radiation Exposure Statement:

This equipment complies with ISED radiation exposure limits set forth for an uncontrolled environment. This equipment should be installed and operated with minimum distance 20cm between the radiator & your body.

Déclaration d'exposition aux radiations:

Cet équipement est conforme aux limites d'exposition aux rayonnements ISED établies pour un environnement non contrôlé. Cet équipement doit être installé et utilisé avec un minimum de 20 cm de distance entre la source de rayonnement et votre corps.

Notes

Notes

Rinnai America Corporation

103 International Drive
Peachtree City, GA 30269
Tel. 1-800-621-9419
Web. www.rinnai.us
www.rinnai.ca

800000218(02)
10/2024